

Microphotonic Devices (Micro-displacement Sensor)

Z4D-C01

Micro-displacement Sensor

- Enable to detect $\pm 10 \mu\text{m}$ level displacement, applicable to detect duplicated paper feeding or deflection amount.
- Displacement output changes by object colors are stabilized with signal divider circuit.
- Operating area = $6.5 \pm 1 \text{ mm}$.

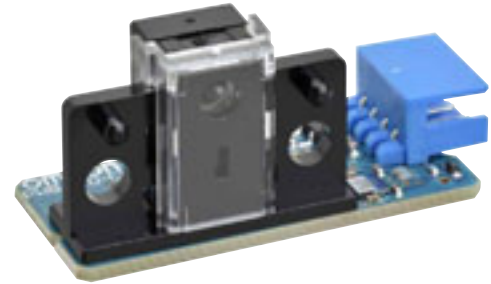

⚠ Be sure to read *Safety Precautions* on page 3.

Ordering Information

Micro-displacement Sensor

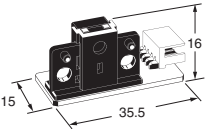
Appearance	Sensing method	Connecting method	Sensing distance	Output type	Model
	Triangulation	Connector	$6.5 \pm 1 \text{ mm}$	Analog output	Z4D-C01

Ratings, Characteristics and Exterior Specifications

Absolute Maximum Ratings ($T_a = 25^\circ\text{C}$)

Item	Symbol	Rated value	Unit	Remarks
Supply voltage	V_{CC}	7	V	---
LED pulse light emission control signal	PLS	7	V	LED
LED light emission pulse	t_{FP}	100	ms	Please refer Pulsed Forward Current Rated Curve
Operating temperature	T_{opr}	-10 to +65	$^\circ\text{C}$	No freezing or condensation
Storage temperature	T_{stg}	-25 to +80	$^\circ\text{C}$	---

Note: Refer to Pulsed Forward Current Rated Curve.

Characteristics ($T_a = 25^\circ\text{C}$)

Object: N8.5 Munsell paper with a reflection factor of 70%.

Item	Value
Operating area *1	$6.5 \pm 1 \text{ mm}$
Sensitivity variation *2	$-1.4 \text{ mV}/\mu\text{m} \pm 10\% \text{ max.}$
Resolution *3	$\pm 10 \mu\text{m} \text{ max.}$
Linearity *4	2% F.S. (full scale) max.

*1. Distance from Mounting Reference Plane to Target.

*2. The sensitivity is defined as slope of the line and it represents the variation in the output voltage per unit length between different products.

$$\text{Sensitivity variation} = \frac{V_1 - V_0}{2000} \quad (\text{mV}/\mu\text{m})$$

V_0 : Output voltage at the point d_0
 V_1 : Output voltage at the point d_1
 d_0, d_1 : Distance between datum clamp face and detective object

d_0	5.5 mm
d_1	7.5 mm

*3. This is the value of the electrical noise width in the output signal converted to a distance under the following conditions.

- (1) Noise width is measured in a waveform after the four times average with an oscilloscope.
- (2) Ripple noise in the power supply voltage (V_{CC}): 10 mVp-p max.
- (3) Distance from mounting reference plane to target: 6.5 mm
- (4) Resolution is measured by the voltage of response delay time (t_{r2}).

*4. This is the peak-to-peak value of the deviation of the signal output from a straight line.

A linearity of 2% F.S. indicates the following value:

- (1) Distance full-scale converted value: $2 \text{ mm} \times 0.02 = 0.04 \text{ mm}$ (40 μm)
- (2) Output voltage converted value: $1.4 \text{ mV}/\mu\text{m} \times 40 \mu\text{m} = 56 \text{ mV}$ (for a sensor with a sensitivity of 1.4 mV/ μm)

Exterior Specification

Connecting method	Weight (g)	Material		
		Case	Cover	Lens
Connector	3.6	Polycarbonate	Polycarbonate	PMMA

Electrical and Optical Characteristics ($T_a = -10^\circ\text{C}$ to 65°C)

Item	Symbol	Rated value	Remarks
Power supply voltage	V_{CC}	5 V $\pm 10\%$	Ripple (p-p): 10 mV p-p max.
Output voltage	OUT	0.2 V to ($V_{CC} - 0.3$) V	*1
Response delay time	t_{r1}	100 μs max.	*2
	t_{r2}	500 μs max.	*3
LED pulse light emission control signal voltage	PLS	3.5 V to V_{CC}	---

*1. Load impedance (between OUT-GND) is set at more than 10 k Ω .

*2. t_{r1} : Rise time of output voltage from 10% to 90%.

*3. t_{r2} : Setup time from PLS rising edge to measured output value rising edge.

Engineering Data (Reference value)

Fig 1. Operating Distance Characteristics (Typical)

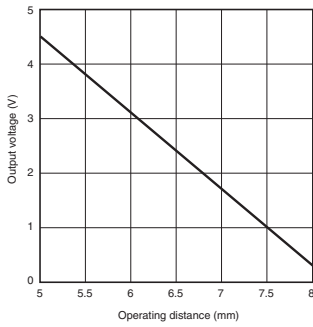

Fig 2. Dependency of Object on Reflection Factor (Typical)

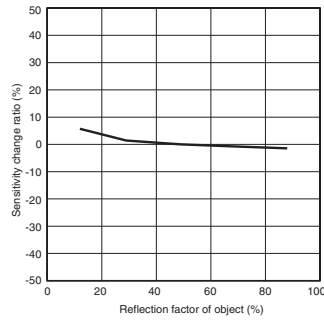

Fig 3. Temperature Characteristics (Typical)

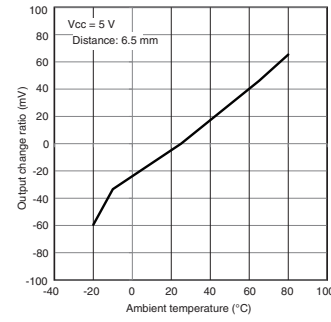
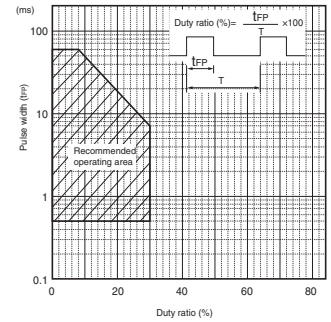
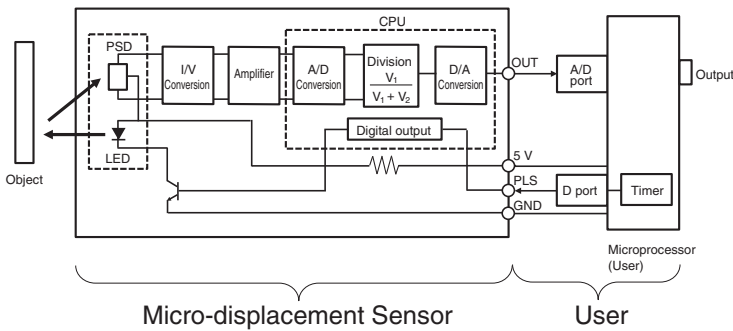

Fig 4. Pulsed Forward Current Rated Curve



Circuit diagram/Connection diagram



- Output voltage signal is obtained by applying the pulse signal at PLS terminal. Please be careful, it is not obtained by DC voltage applying.

Pulse Input and Sensor Output

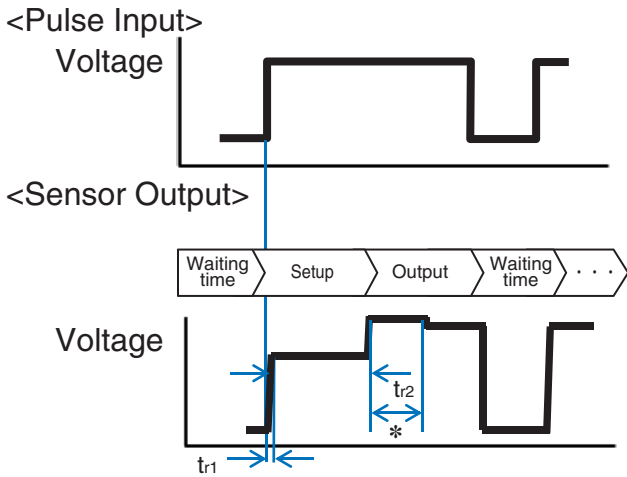

- Output voltage depends on input. After setup time t_{r2} , output signal is obtained according to the distance.
- After setup, output signal is updated every 80 micro seconds.

* Update every 80 micro seconds. Output signal is reset at pulse input signal falling low level, and start setup over again after next input signal applying.

Application Examples

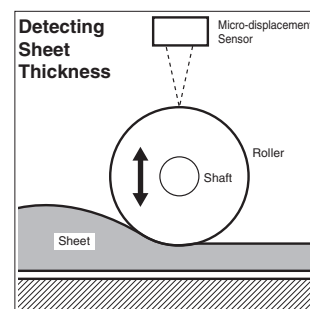
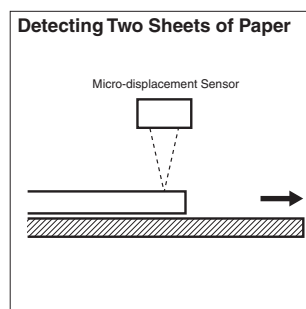
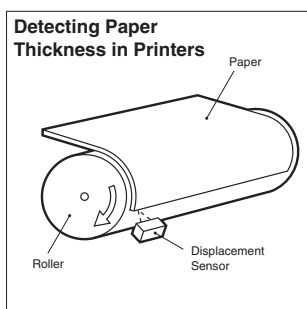

Safety Precautions

To ensure safe operation, be sure to read and follow the Instruction Manual provided with the Sensor.

CAUTION

This product is not designed or rated for ensuring safety of persons either directly or indirectly. Do not use it for such purposes.



Precautions for Correct Use

Do not use the product in atmospheres or environments that exceed product ratings. This product is for surface mounting. Refer to Soldering Information, Storage and Baking for details.

Dispose of this product as industrial waste.

Precautions for Safe Use

Do not use the product with a voltage or current that exceeds the rated range.

Applying a voltage or current that is higher than the rated range may result in explosion or fire.

Do not miswire such as the polarity of the power supply voltage.

Otherwise the product may be damaged or it may burn.

This product does not resist water. Do not use the product in places where water or oil may be sprayed onto the product.

Dimensions

(Unit: mm)

Micro-displacement Sensor

Z4D-C01

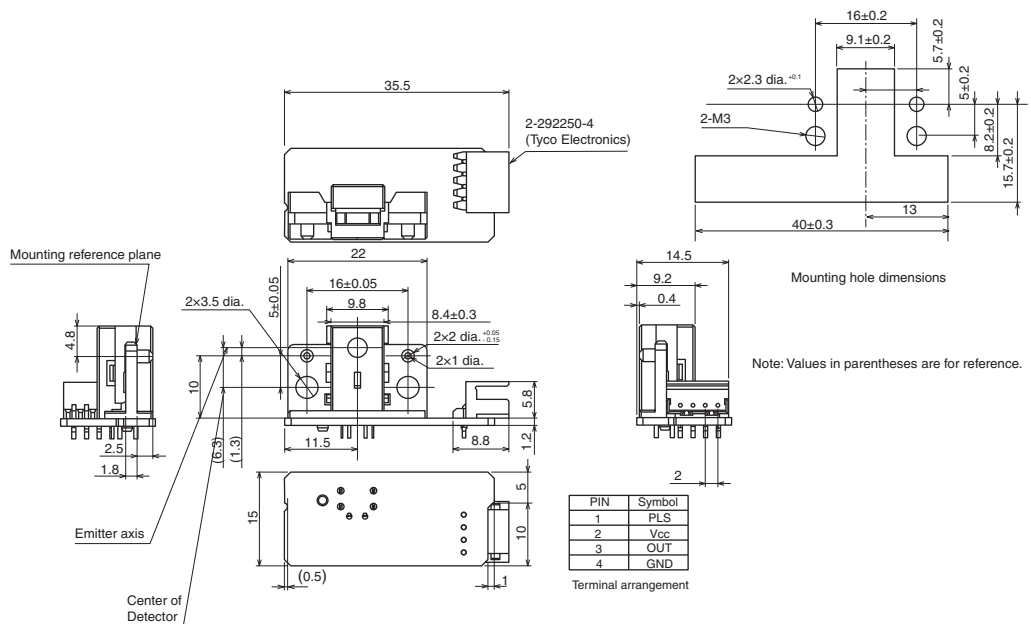

Recommended Mating Connectors: Tyco Electronics 179228-4 (crimp-type connector)
173977-4 (insulation displacement crimp connector)

- Application examples provided in this document are for reference only. In actual applications, confirm equipment functions and safety before using the product.
- Consult your OMRON representative before using the product under conditions which are not described in the manual or applying the product to nuclear control systems, railroad systems, aviation systems, vehicles, combustion systems, medical equipment, amusement machines, safety equipment, and other systems or equipment that may have a serious influence on lives and property if used improperly. Make sure that the ratings and performance characteristics of the product provide a margin of safety for the system or equipment, and be sure to provide the system or equipment with double safety mechanisms.

Note: Do not use this document to operate the Unit.