

Timer Provides Prompted Programming,  
Flexibility in Programs Within the Week

- AM/PM display
- 24 program steps
- A different program possible each day
- Over midnight settings possible
- Two independent 15 A control circuits with manual override
- Automatic or manual operation following power failure
- Field-adjustable ON/OFF, cycle and pulse output
- Easy-to-use prompted programming
- Wide supply voltage range
- Battery backup for memory protection
- Protective cover and other accessories may be ordered separately

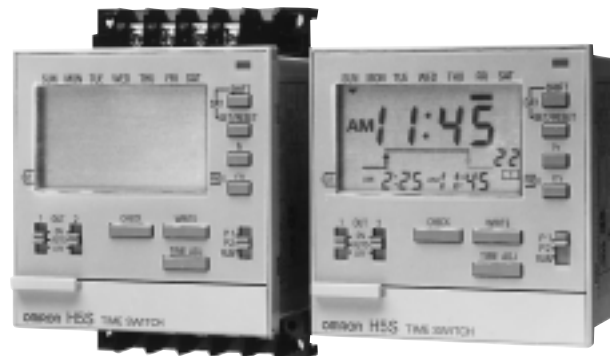

## Ordering Information

### ■ TIMERS

Timing function	ON/OFF and cycle operations up to one week	
Contact type	Two SPST-NO time limit contacts with manual override switches	
Terminal form	Screw terminals	
Mounting	Panel mounting	Surface or track mounting
Part number	H5S-B	H5S-FB
Supply voltage	100 to 240 VAC, 50/60 Hz	

### ■ TIME RANGES

Time setting range	00:00 a.m. to 11:59 p.m.
Program capacity	24 steps: ON = 1 step, OFF = 1 step, CYCLE = 4 steps, PULSE = 1 step
Cycle length	From 1 minute up to a full week
Display time division	1 minute
Operation	Weekly operation (multiple-day operation possible) Cycle operation Pulse-out operation (pulse width can be set in units of 1 second from 1 to 59 seconds and in units of 1 minute from 1 to 60 minutes) Day override operation (operation for one day can be also executed on any other day) Forced ON/OFF operation Manual or automatic operation selectable on recovery from power failure

### ■ ACCESSORIES

Description	Part number
Hard plastic cover	Y92A-72C
Track mounting adapter for H5S-FB	Y92F-90
Mounting track	50 cm (1.64 ft) length
	1 m (3.28 ft) length
	End plate
	PFP-50N
	PFP-100N
	PFP-M

# Specifications

Part number		H5S-B	H5S-FB
Supply voltage	AC	100 to 240 V, 50/60 Hz	
	DC	-	
Operating voltage		85 to 110% of rated voltage (85 to 264 VAC), 50/60 Hz	
Power consumption	AC	10 VA	
	DC	-	
Timing functions		ON and OFF programming	
Reset (boot) input		No-voltage, 0.2 sec minimum	
Control output	Type	Time limit	SPST-NO x 2 circuits
		Pulse	1 sec to 59 seconds or 1 min to 60 min
	Max. load	15 A, 250 VAC resistive load	
	Min. load	100 mA, 5 VDC	
Repeat accuracy		±0.01%, ±0.05 second max.	
Long-term error		±15 seconds per month at 25°C (77°F); ±4 seconds/week, ±1 minute/4 months	
Setting error		Included in "Repeat Accuracy"	
Indicators		10 mm LCD; day, hours (a.m., p.m.), minutes (0:00 to 11:59 a.m., 0:00 to 11:59 p.m.) Digital display of program steps during operation Timing chart display of program steps during operation	
Materials		Plastic	
Mounting		Panel	Surface and track with adapter
Connections		Terminal screws	
Weight		200 g (7 oz.)	
Approvals		UL/CSA/SEV	
Operating ambient temperature		-10° to 55°C (14° to 131°F)	
Humidity		35 to 85% RH	
Vibration	Mechanical durability	10 to 55 Hz, 0.75 mm (0.03 in) double amplitude	
	Malfunction durability	10 to 55 Hz, 0.5 mm (0.02 in) double amplitude	
Shock	Mechanical durability	30 G	
	Malfunction durability	10 G	
Variation due to voltage change		Included in "Repeat accuracy"	
Variation due to temperature change		Included in "Repeat accuracy"	
Insulation resistance		100 MΩ minimum between current-carrying terminals and non-current-carrying metal parts; operation circuit and contact control output circuit; non-continuous contacts	
Dielectric strength		2,000 VAC, 50/60 Hz for 1 minute between current-carrying terminals and non-current-carrying metal parts, and operation circuit and contact control output circuit. 1,000 VAC, 50/60 Hz for 1 minute between non-continuous contacts	
Service life	Electrical	50,000 operations minimum, 15 A, 250 VAC, resistive load 50,000 operations minimum, 1 HP, 250 VAC, motor load 50,000 operations minimum, 10 A, 250 VAC, inductive load (p.f.=0.7) 50,000 operations minimum, 100 W, 100 VAC, lamp load 10,000 operations minimum, 300 W, 100 VAC, lamp load	

# Dimensions

Unit: mm (inch)

## ■ TIMERS

### H5S-B Panel-Mounting Type

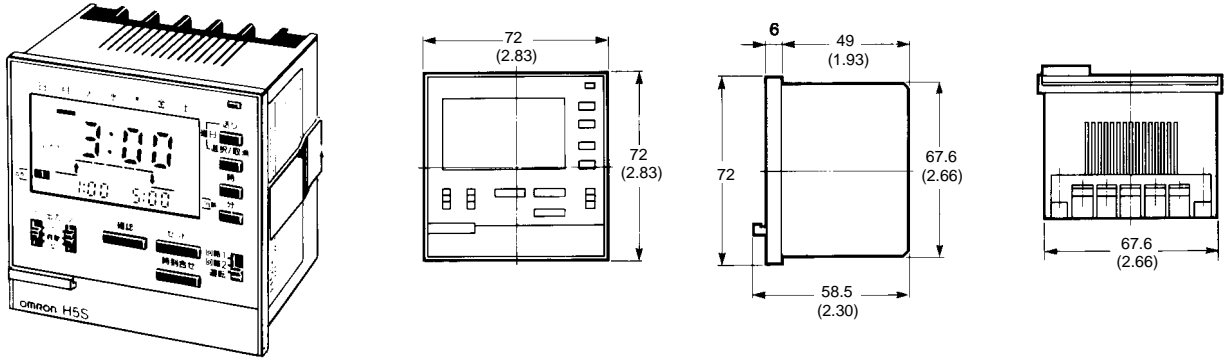

### H5S-FB Surface-Mounting Type

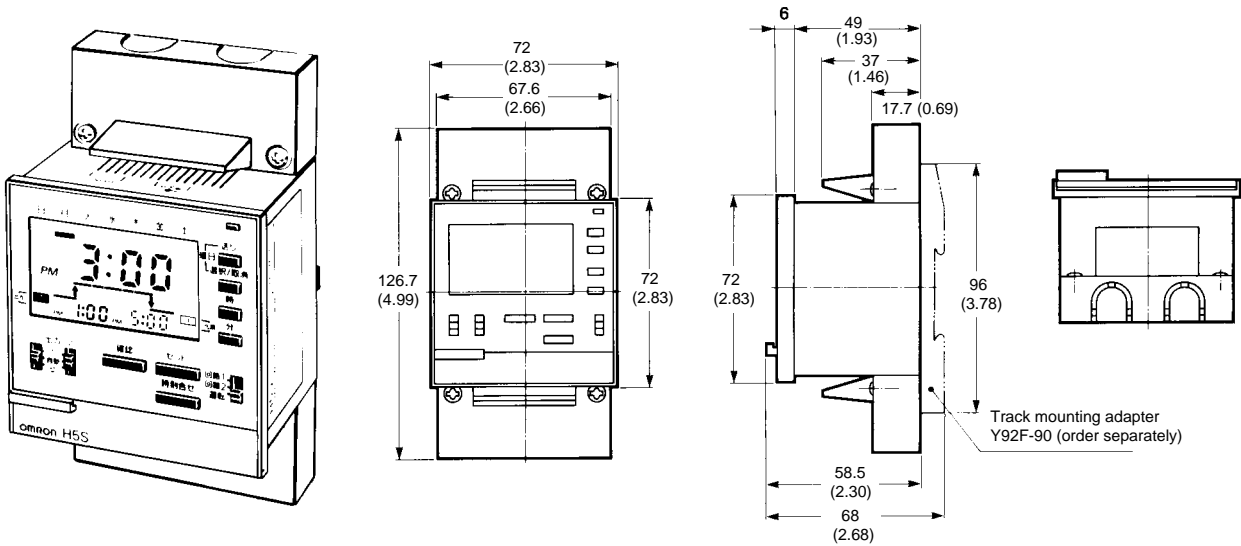

## ■ PROTECTIVE COVER

### Y92A-72C

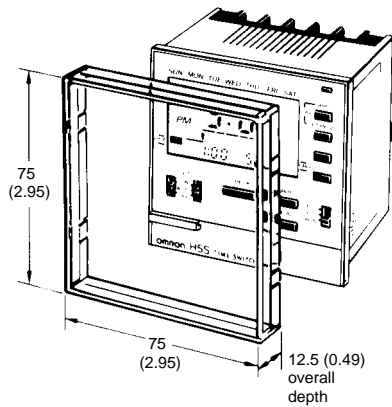

The hard plastic protective cover prevents accidental resetting. It also shields the front panel from dirt and water. The cover is intended for use in areas where unusual service conditions do not exist.

■ TRACK MOUNTING ADAPTER

Y92F-90

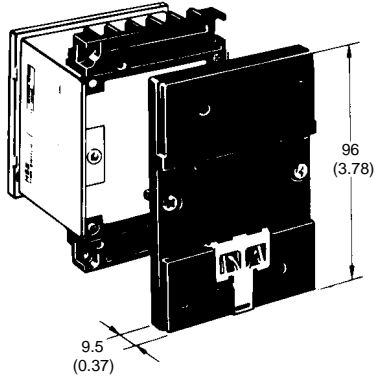

The H5S-FB timer can be mounted on DIN rail track using the Y92F-90 adapter. Two screws supplied with the timer fasten the adapter to the timer.

■ MOUNTING TRACK AND ACCESSORIES

FFP-100N/FFP-50N DIN Rail

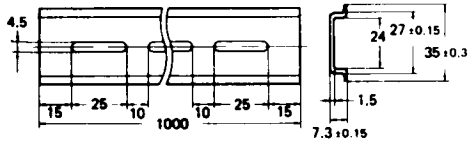

FFP-M End Plate

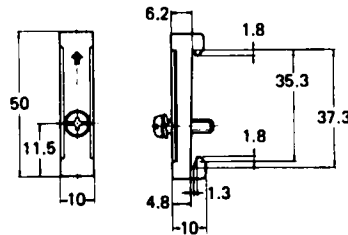

Connections

■ H5S-B PANEL MOUNTING TYPE

(Rear view)

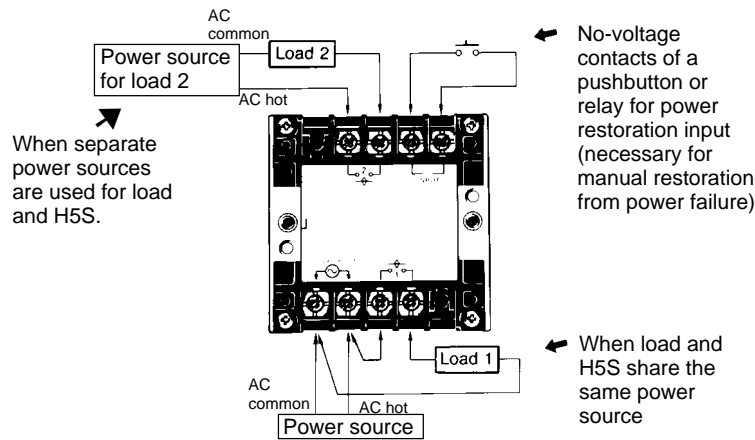

■ H5S-B PANEL MOUNTING TYPE

(Rear view)

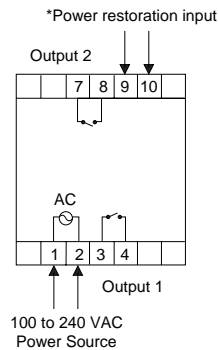

■ H5S-FB SURFACE MOUNTING TYPE

(Front view)

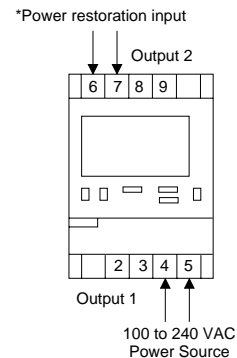

■ H5S-FB SURFACE MOUNTING TYPE

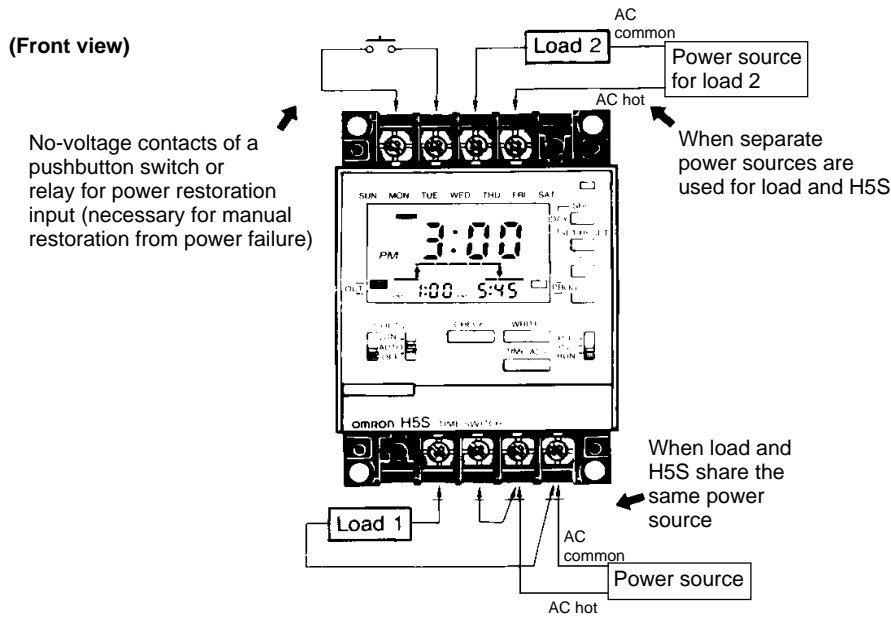

Operation

■ NOMENCLATURE

Front Panel with Cover Open

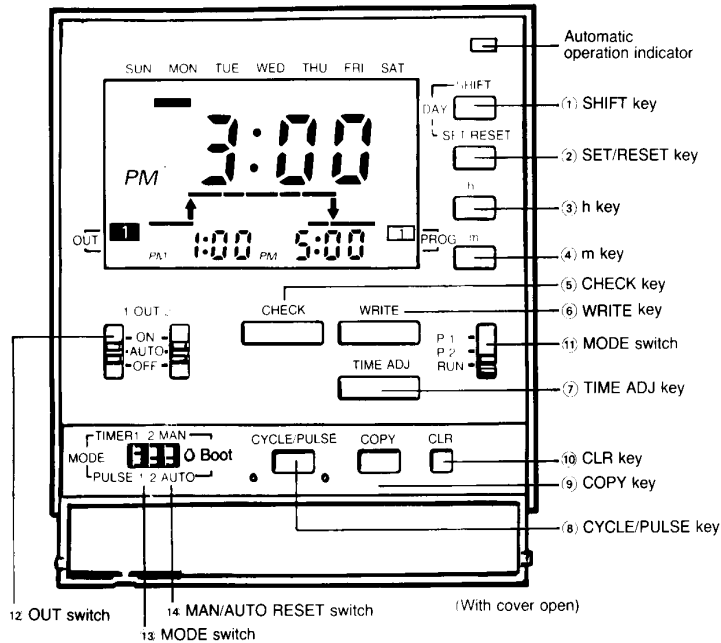

Key Operations

No.	Function
①	Shifts the cursor (▼) specifying a day to the right.
②	Sets or cancels a specified day.
③	Sets a time or ON/OFF time width.
④	
⑤	Monitors the parameters set for an operation during an operation.
⑥	Sets parameters.
⑦	Sets a time adjustment mode.
⑧	Specifies a cyclic operation, or sets a pulse width.
⑨	Specifies a day substitution operation.
⑩	Cancels the parameters set for each circuit, or a day substitution operation.
⑪	P1: Circuit 1 programming mode P2: Circuit 2 programming mode RUN: RUN mode
⑫	ON: Turns on the output regardless of the program. AUTO: Executes according to the program. OFF: Turns off the output regardless of the program.
⑬	TIMER: Executes an ordinary timer or cyclic operation. PULSE: Executes a pulse-output operation.
⑭	Specifies automatic or manual operation following a power failure.

Display

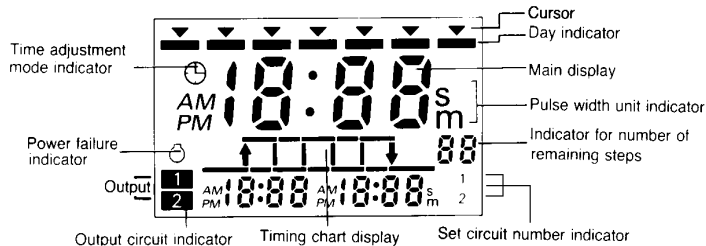

■ OPERATING FUNCTIONS

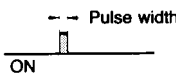
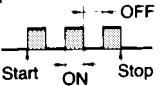
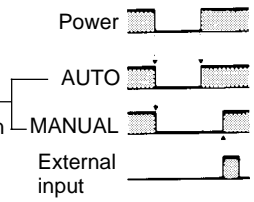
<p><b>Timer Operation</b></p> 	<p>Controls the output according to the set time of ON and OFF (the time can be set in units of 1 minute)</p>
<p><b>Pulse-Output operation</b></p> 	<p>Produces the output for a fixed duration at the set ON (pulse width: 1 to 59 seconds, or 1 minute to 59 minutes). The pulse width can be set in units of 1 second or 1 minute.</p>
<p><b>Cycle operation</b></p> 	<p>Repeatedly performs an ON/OFF operation during a specific period, which can be set in units of 1 minute</p>
<p><b>Forced ON/OFF operation</b></p>	<p>Forcibly turns ON/OFF the output by a slide switch</p>
<p><b>Operation on power restoration</b></p> 	<p>AUTO: Operation is automatically started on power recovery                  MANUAL: Operation is started by applying an external no-voltage signal of 0.2 sec minimum after power recovery.</p> <p>Note that the signal must be a low to high transition (open to closed switching).</p>
<p><b>Day override operation</b></p>	<p>Executes a day's operation on another day. The specified new operation is performed only for one week. This could be used for holidays.</p>

■ PROGRAMMING

Before setting the parameters necessary for each operation, the operation of circuits (outputs 1 and 2) must be determined. Also, specify whether the operation is restarted automatically or manually after power failure recovery.

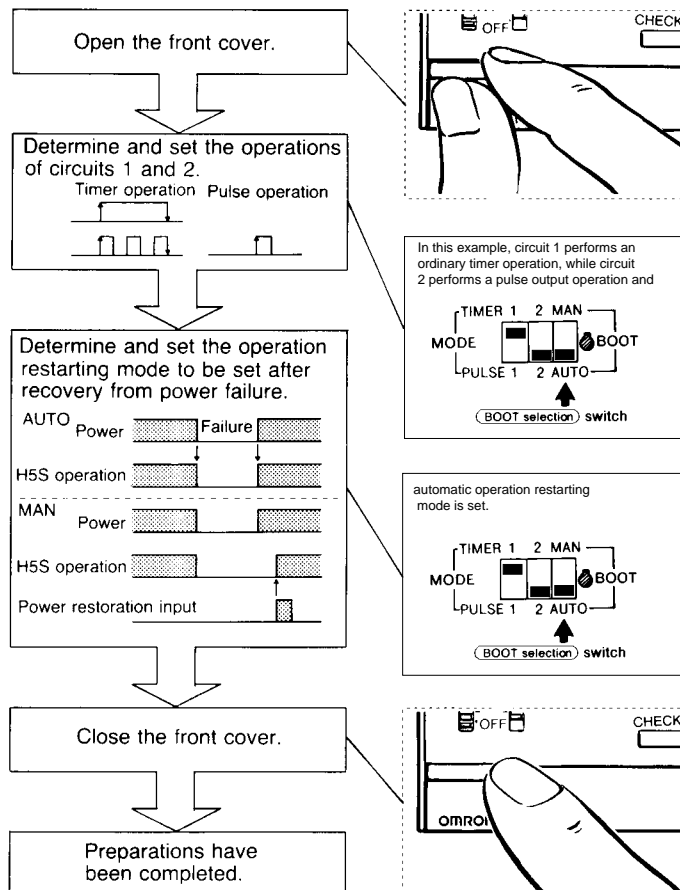

### Time Adjustment

The following figures show how to set the time to 10:30 a.m., Wednesday. Mode selector switch should be in RUN position.

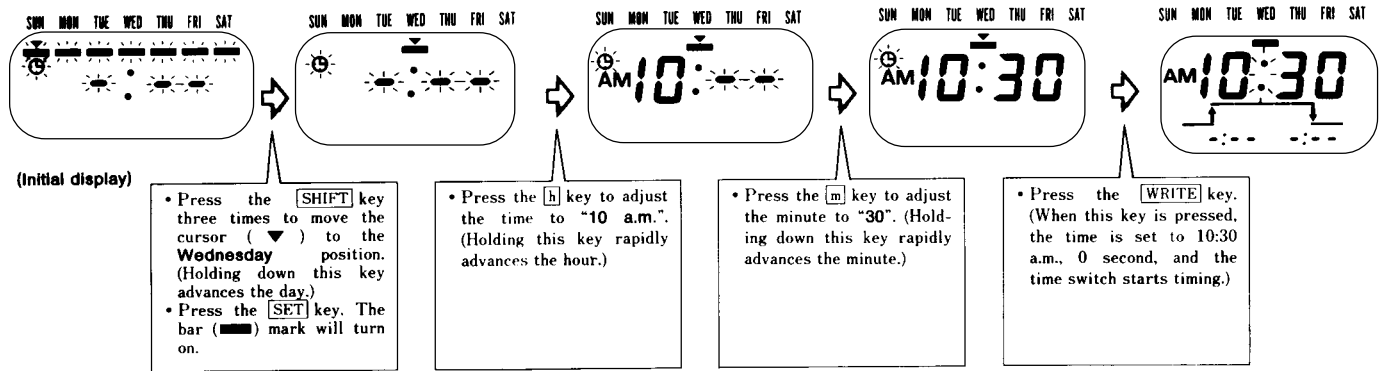

The time and day can also be adjusted or changed while the timer is operating. In the following example, the current set time, 10:30 a.m., Wednesday, is changed to 4:00 a.m., Monday.

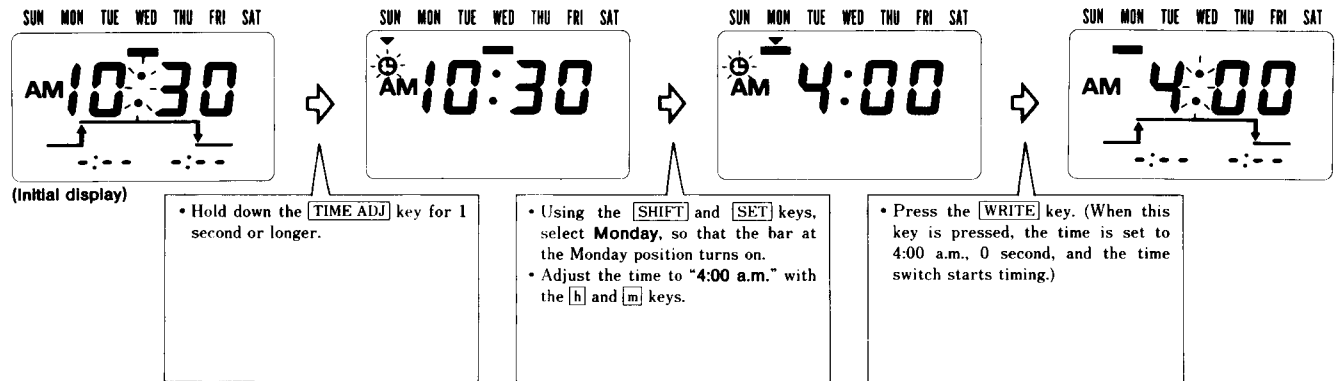

### Ordinary Timer Operation

In this example, circuit 1 is set to operate at 8:30 a.m. and stop at 5:15 p.m., from Monday through Friday. Set mode switch to P1.

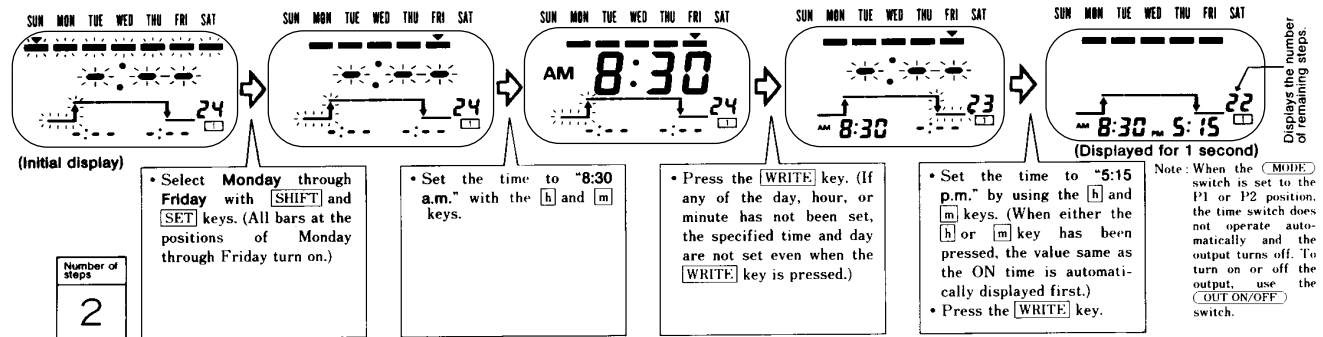
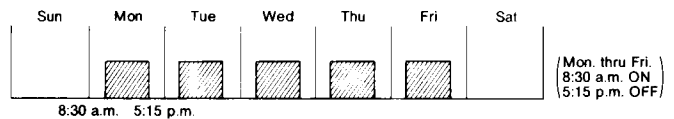

### Multiple-Day Operation

The timer turns ON circuit 1 at 8:30 a.m. on Monday, and turns it OFF at 0:00 p.m. on Saturday. Set mode selector to P1.

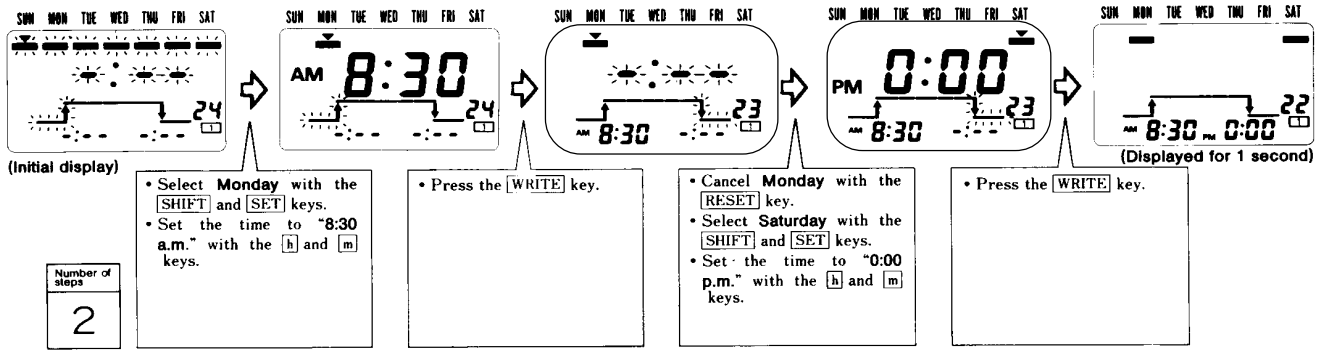
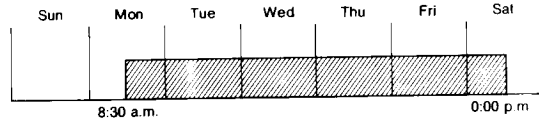

### Cycle Operation

Circuit 1 is set to turn ON for 2 minutes and OFF for 1 minute repeatedly, from 8:30 a.m. to 5:15 p.m. on Monday. Set mode selector to P1.

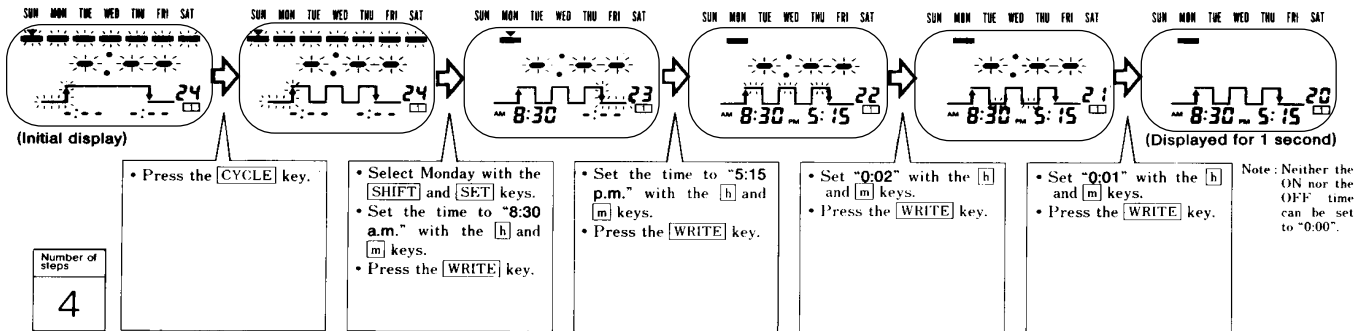
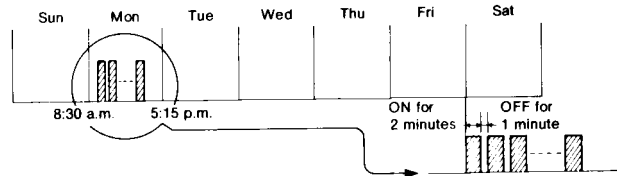

### Pulse Output Operation

Circuit 2 is turned ON for 30 seconds at 8:25 a.m., Monday through Friday. Set mode selector to P2.

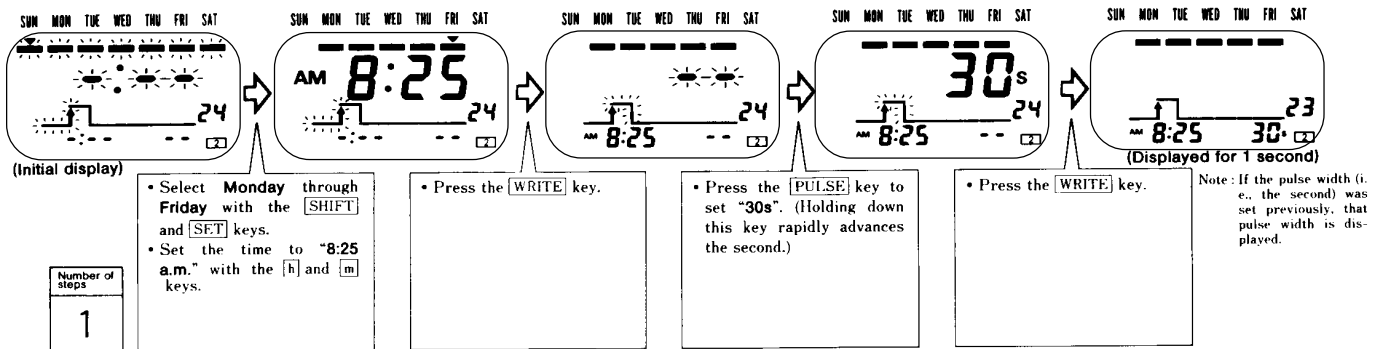
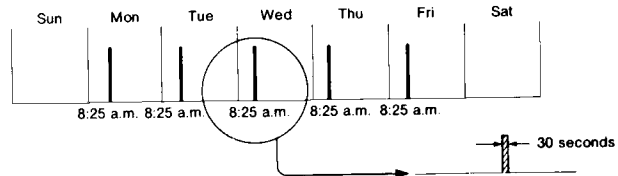



### Checking the Set Time

The set times can be checked and, if necessary, changed in the sequence they were set. In this example, the times set for circuit 1 are checked. Set mode selector switch to P1.

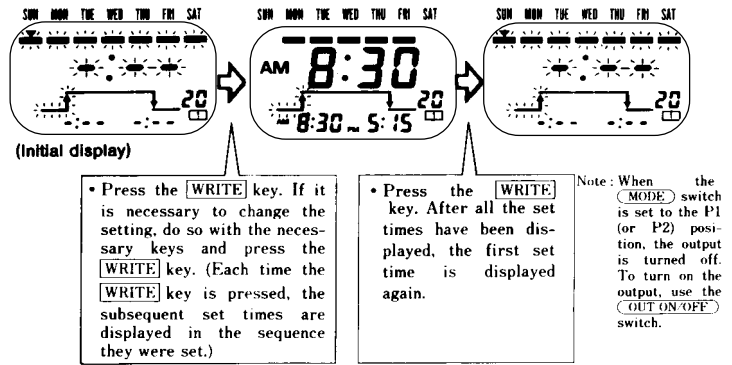

The set times can be checked in the sequence the timer is to operate. In the following example, the times set for today are checked. Set mode selector switch to RUN.

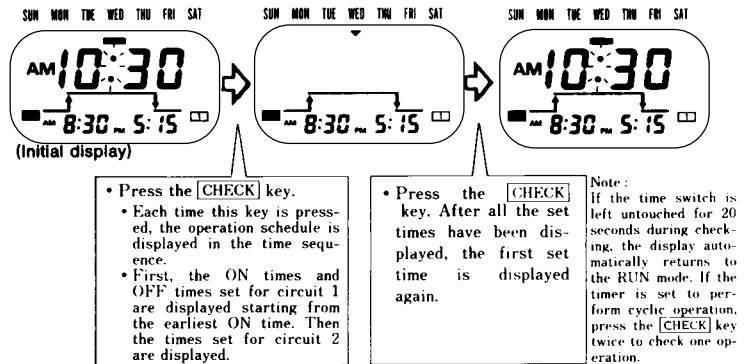

It is also possible to check the timing operations in the sequence they are to be executed. The operations to be performed Thursday are checked. Mode selector switch is in RUN.

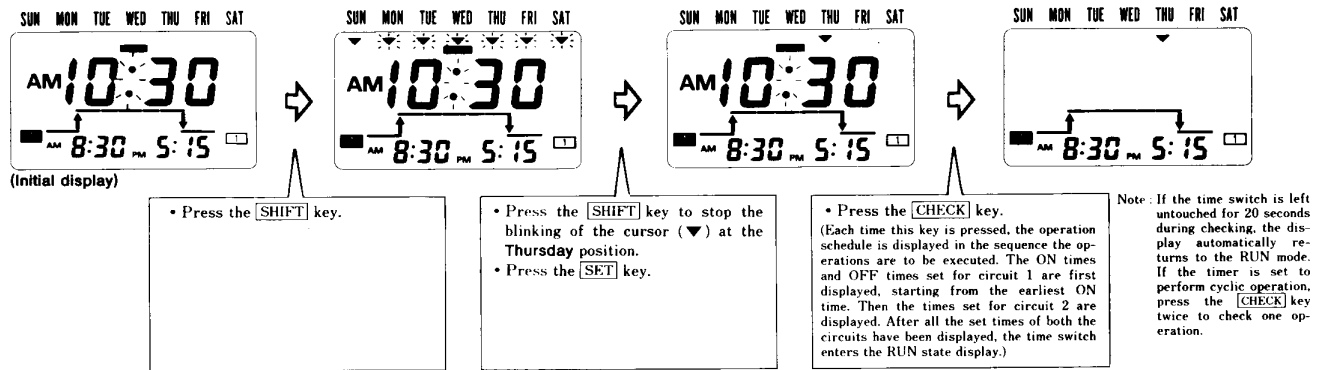

### Day Override

Wednesday and Thursday are holidays in the next week, the operations set for Sunday will be executed on these days. (The time switch executes the new program for only one week from the day next to when the program is set. After the one week, the timer operates according to the previous program.)

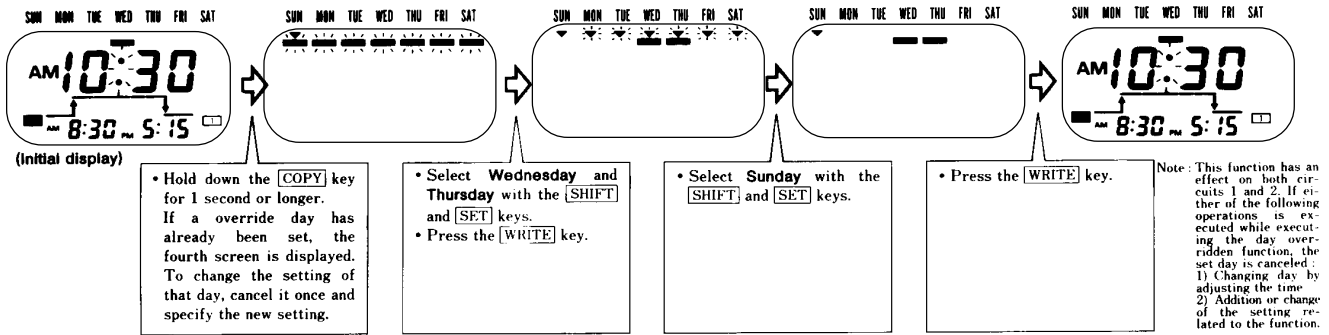

### Canceling the Setting

All the operations of circuit 1 or 2 can be cancelled. In the following example, all the operations of circuit 1 are cancelled. Set mode selector switch to P1.

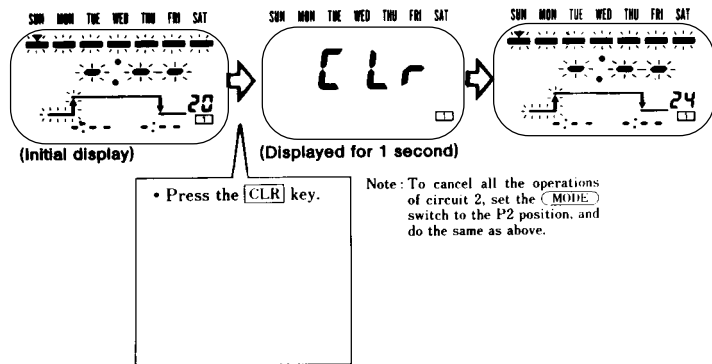

In the next example an overridden operation is cancelled. Set mode selector to RUN.

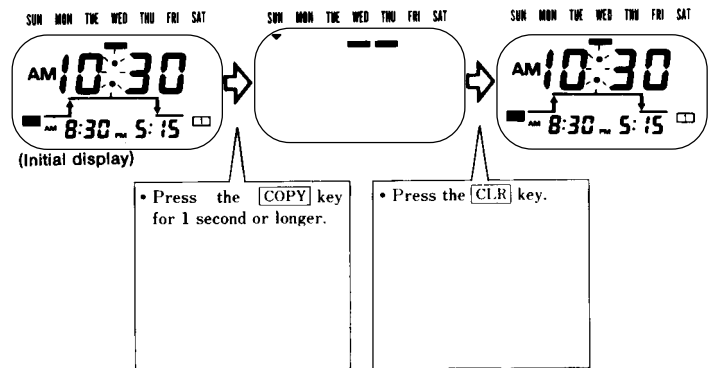

## PRECAUTIONS

### Ordinary Timer Operation

The earlier ON time takes precedence.

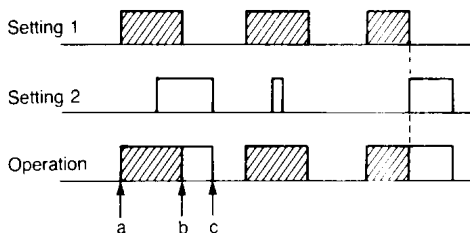

If both settings 1 and 2 are for an ON/OFF or pulse operation, the output is continuously produced without being interrupted. For example, if setting 1 is for cyclic operation, and 2 is set for an ON/OFF operation, the cyclic operation is performed during period of a to b, and the ON/OFF operation is performed from b to c.

### Multiple-Day Operation

If more than one day is specified and when the output is turned on, it is turned off on the day when the first OFF time is set.

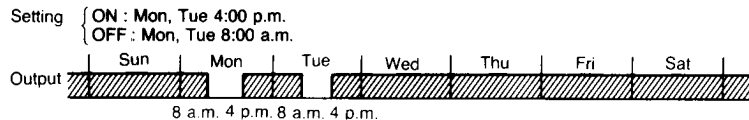

If an ON and an OFF have been set at the same time of the same day (such setting is possible), no operation is performed.

If the MODE switch is set to the P1 (or P2) position, no output is produced. Therefore, after setting has been done, set the MODE switch to the RUN position and confirm that the automatic operation indicator lights.

The set data may be erased if the OUT switch is moved between the TIMER and PULSE positions after the data has been set.

## Mounting

### ■ PANEL MOUNTING H5S-B

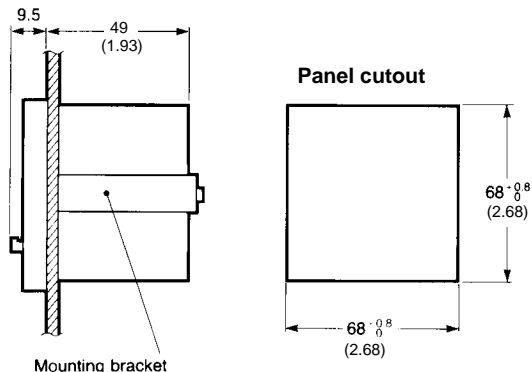

### ■ SURFACE MOUNTING H5S-FB

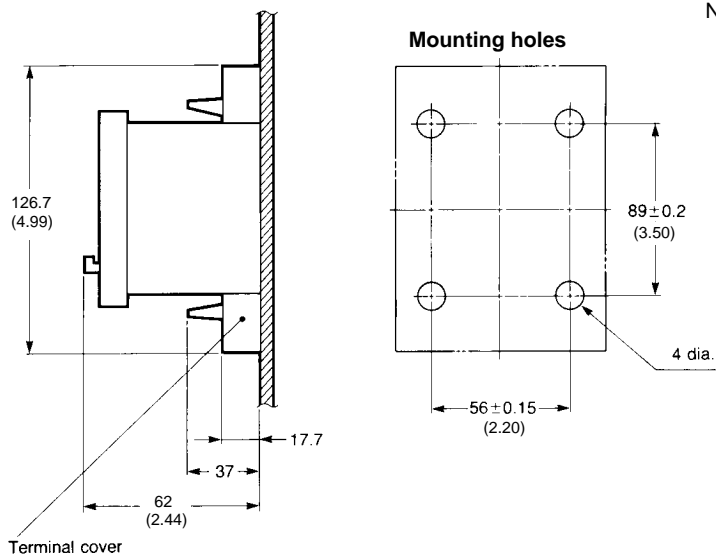

Note: Mounting hole diameter varies with the panel thickness and material. The table below is for soft iron panel.

Panel thickness	0.8 to 1.2 mm (0.03 to 0.05 in)	1.6 to 4.0 mm (0.06 to 0.16 in)
Hole diameter	3.6 mm (0.12 in)	3.7 mm (0.146 in)

For diecast aluminum panels, the hole diameter should be larger, 4 mm (0.157 in) diameter as shown.

**■ TRACK MOUNTING H5S-FB**

Use Y92F-90 Track Mounting Base

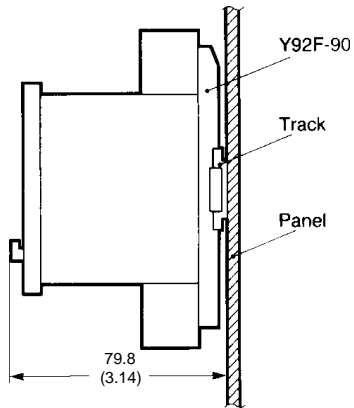

**NOTE: ALL DIMENSIONS ARE IN MILLIMETERS. To convert millimeters into inches divide by 25.4.**

**OMRON**Omron Europe B.V. EMA-ISD, tel:+31 23 5681390, fax:+31 23 5681397, <http://www.eu.omron.com/ema>