

# UNR921xG Series

## Silicon NPN epitaxial planar type

For digital circuits

### ■ Features

- Costs can be reduced through downsizing of the equipment and reduction of the number of parts.
- SS-Mini type package, allowing automatic insertion through tape packing.

### ■ Resistance by Part Number

	Marking Symbol	(R <sub>1</sub> )	(R <sub>2</sub> )
• UNR9210G	8L	47 kΩ	—
• UNR9211G	8A	10 kΩ	10 kΩ
• UNR9212G	8B	22 kΩ	22 kΩ
• UNR9213G	8C	47 kΩ	47 kΩ
• UNR9214G	8D	10 kΩ	47 kΩ
• UNR9215G	8E	10 kΩ	—
• UNR9216G	8F	4.7 kΩ	—
• UNR9217G	8H	22 kΩ	—
• UNR9218G	8I	0.51 kΩ	5.1 kΩ
• UNR9219G	8K	1 kΩ	10 kΩ
• UNR921AG	8X	100 kΩ	100 kΩ
• UNR921BG	8Y	100 kΩ	—
• UNR921CG	8Z	—	47 kΩ
• UNR921DG	8M	47 kΩ	10 kΩ
• UNR921EG	8N	47 kΩ	22 kΩ
• UNR921FG	8O	4.7 kΩ	10 kΩ
• UNR921KG	8P	10 kΩ	4.7 kΩ
• UNR921LG	8Q	4.7 kΩ	4.7 kΩ
• UNR921MG	EL	2.2 kΩ	47 kΩ
• UNR921NG	EX	4.7 kΩ	47 kΩ
• UNR921TG	EZ	22 kΩ	47 kΩ
• UNR921VG	FD	2.2 kΩ	2.2 kΩ

### ■ Package

- Code  
SSMini3-F3
- Pin Name  
1: Base  
2: Emitter  
3: Collector

### ■ Internal Connection

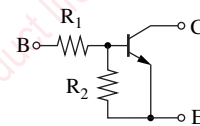

### ■ Absolute Maximum Ratings T<sub>a</sub> = 25°C

Parameter	Symbol	Rating	Unit
Collector-base voltage (Emitter open)	V <sub>CBO</sub>	50	V
Collector-emitter voltage (Base open)	V <sub>CEO</sub>	50	V
Collector current	I <sub>C</sub>	100	mA
Total power dissipation	P <sub>T</sub>	125	mW
Junction temperature	T <sub>j</sub>	125	°C
Storage temperature	T <sub>stg</sub>	-55 to +125	°C

**■ Electrical Characteristics**  $T_a = 25^\circ\text{C} \pm 3^\circ\text{C}$ 

Parameter		Symbol	Conditions	Min	Typ	Max	Unit		
Collector-base voltage (Emitter open)		$V_{CBO}$	$I_C = 10 \mu\text{A}, I_E = 0$	50			V		
Collector-emitter voltage (Base open)		$V_{CEO}$	$I_C = 2 \text{ mA}, I_B = 0$	50			V		
Collector-base cut-off current (Emitter open)		$I_{CBO}$	$V_{CB} = 50 \text{ V}, I_E = 0$			0.1	$\mu\text{A}$		
Collector-emitter cut-off current (Base open)		$I_{CEO}$	$V_{CE} = 50 \text{ V}, I_B = 0$			0.5	$\mu\text{A}$		
Emitter-base cut-off current (Collector open)	UNR9210G/9215G/9216G/9217G/921BG	$I_{EBO}$	$V_{EB} = 6 \text{ V}, I_C = 0$			0.01	mA		
	UNR9213G/921AG					0.1			
	UNR9212G/9214G/921DG/921EG/921MG/921NG/921TG					0.2			
	UNR9211G					0.5			
	UNR921FG/921KG					1.0			
	UNR9219G					1.5			
	UNR9218G/921CG/921LG/921VG					2.0			
Forward current transfer ratio	UNR921VG	$h_{FE}$	$V_{CE} = 10 \text{ V}, I_C = 5 \text{ mA}$	6		20	—		
	UNR9218G/921KG/921LG			20					
	UNR9219G/921DG/921FG			30					
	UNR9211G			35					
	UNR9212G/921EG			60					
	UNR9213G/9214G/921AG/921CG/921MG			80					
	UNR921NG/921TG			80	400				
	UNR9210G/9215G/9216G/9217G/921BG			160	460				
Collector-emitter saturation voltage		$V_{CE(sat)}$	$I_C = 10 \text{ mA}, I_B = 0.3 \text{ mA}$			0.25	V		
	UNR921VG					$I_C = 10 \text{ mA}, I_B = 1.5 \text{ mA}$			
Output voltage high-level		$V_{OH}$	$V_{CC} = 5 \text{ V}, V_B = 0.5 \text{ V}, R_L = 1 \text{ k}\Omega$	4.9			V		
Output voltage low-level		$V_{OL}$	$V_{CC} = 5 \text{ V}, V_B = 2.5 \text{ V}, R_L = 1 \text{ k}\Omega$			0.2	V		
				UNR9213G/921BG/921KG	$V_{CC} = 5 \text{ V}, V_B = 3.5 \text{ V}, R_L = 1 \text{ k}\Omega$				
				UNR921DG	$V_{CC} = 5 \text{ V}, V_B = 10 \text{ V}, R_L = 1 \text{ k}\Omega$				
				UNR921EG	$V_{CC} = 5 \text{ V}, V_B = 6 \text{ V}, R_L = 1 \text{ k}\Omega$				
				UNR921AG	$V_{CC} = 5 \text{ V}, V_B = 5 \text{ V}, R_L = 1 \text{ k}\Omega$				
Transition frequency		$f_T$	$V_{CB} = 10 \text{ V}, I_E = -2 \text{ mA}, f = 200 \text{ MHz}$		150		MHz		
Input resistance	UNR9218G	$R_1$		-30%	0.51	+30%	k $\Omega$		
	UNR9219G				1				
	UNR921MG/921VG				2.2				
	UNR9216G/921FG/921LG/921NG				4.7				
	UNR9211G/9214G/9215G/921KG				10				
	UNR9212G/9217G/921TG				22				
	UNR9210G/9213G/921DG/921EG				47				
	UNR921AG/921BG				100				

Note) Measuring methods are based on JAPANESE INDUSTRIAL STANDARD JIS C 7030 measuring methods for transistors.

■ Electrical Characteristics (continued)  $T_a = 25^\circ\text{C} \pm 3^\circ\text{C}$

Parameter		Symbol	Conditions	Min	Typ	Max	Unit
Emitter-base resistance	UNR921CG	$R_2$		-30%	47	+30%	k $\Omega$
Resistance ratio	UNR921MG	$R_1/R_2$			0.047		—
	UNR921NG				0.1		
	UNR9218G/9219G			0.08	0.10	0.12	
	UNR9214G			0.17	0.21	0.25	
	UNR921TG				0.47		
	UNR921FG			0.37	0.47	0.57	
	UNR921AG/921VG				1.0		
	UNR9211G/9212G/9213G/921LG			0.8	1.0	1.2	
	UNR921KG			1.70	2.13	2.60	
	UNR921EG			1.70	2.14	2.60	
UNR921DG		3.7	4.7	5.7			

Note) Measuring methods are based on JAPANESE INDUSTRIAL STANDARD JIS C 7030 measuring methods for transistors.

Common characteristics chart

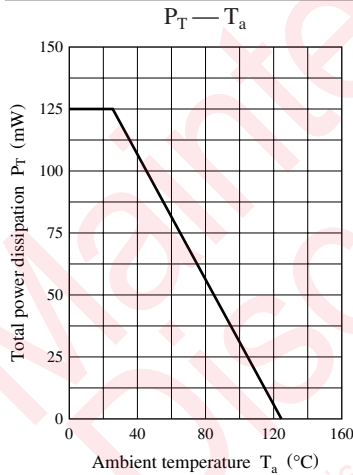

Characteristics charts of UNR9210G

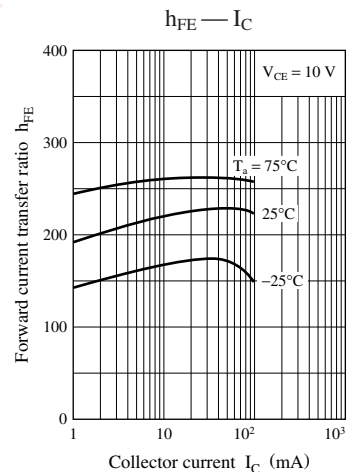
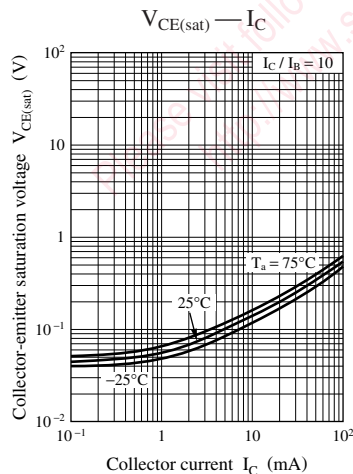
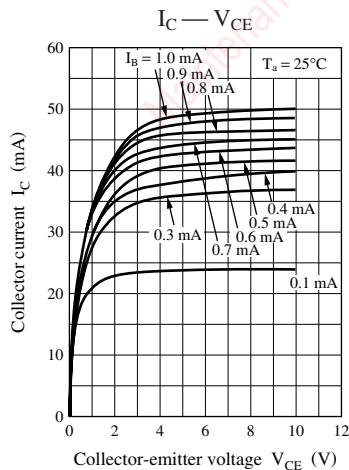

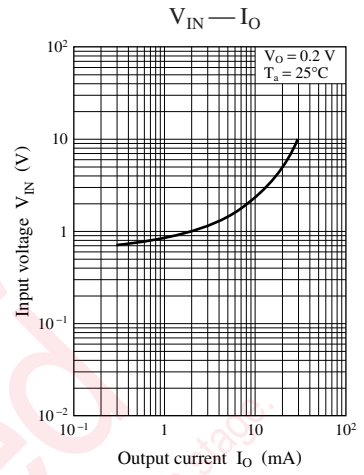
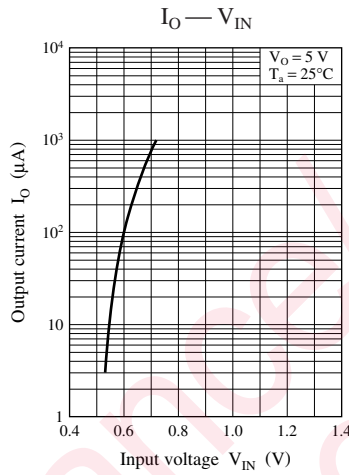
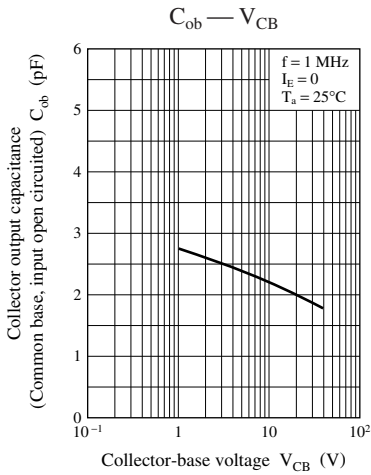

Characteristics charts of UNR9211G

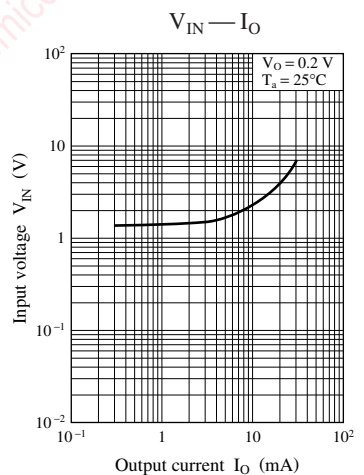
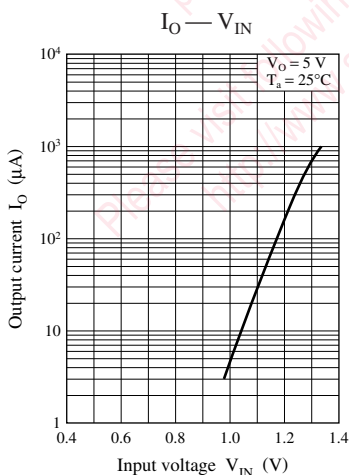
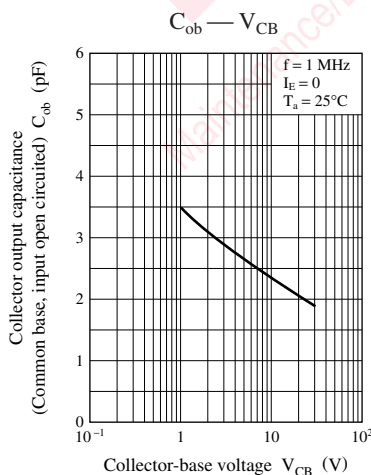
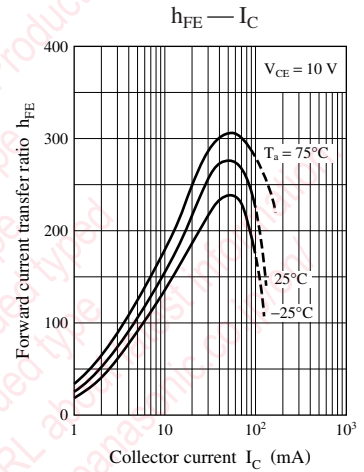
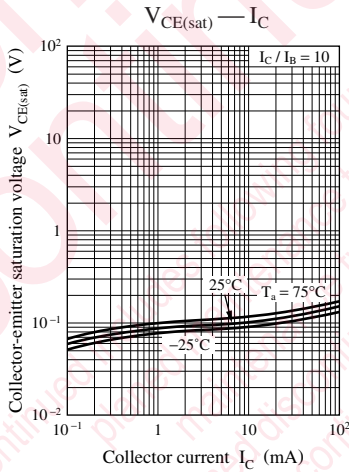
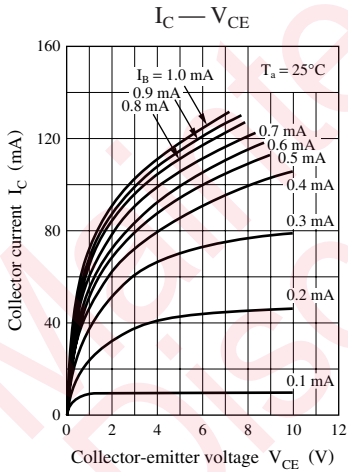

Characteristics charts of UNR9212G

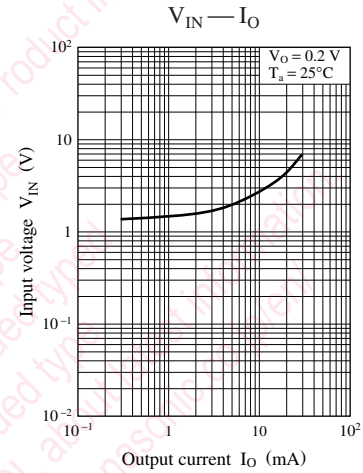
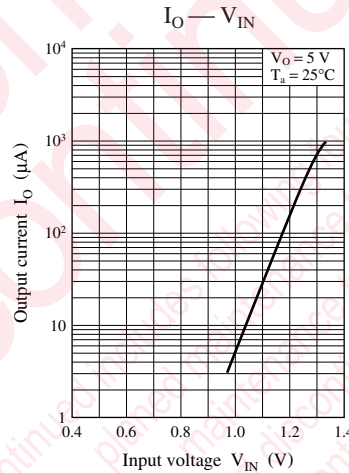
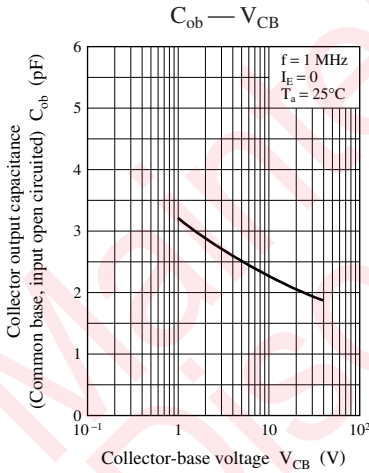
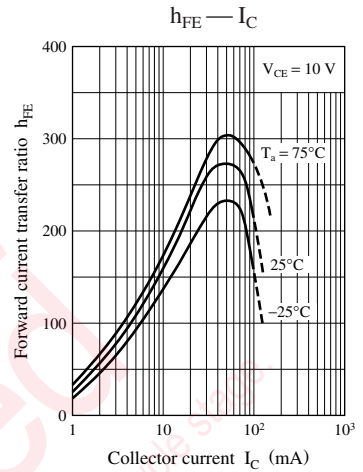
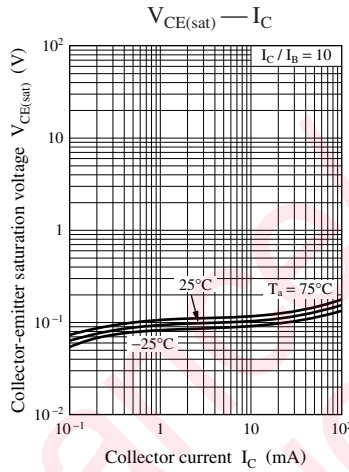
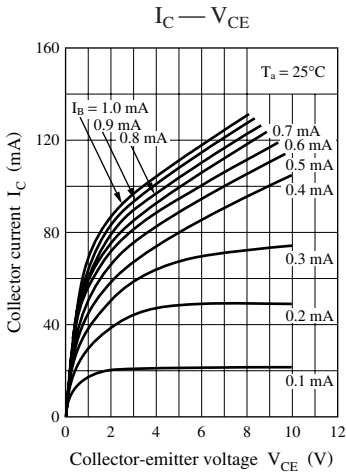

Characteristics charts of UNR9213G

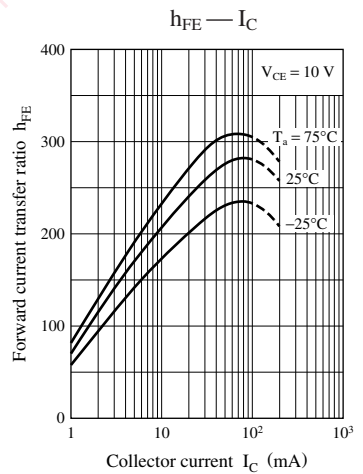
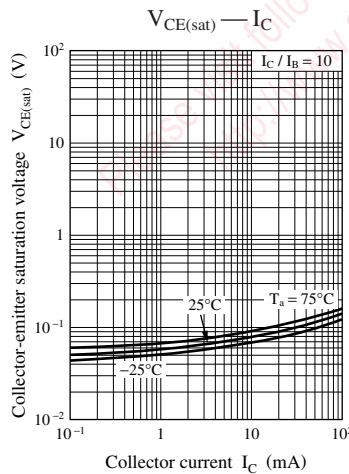
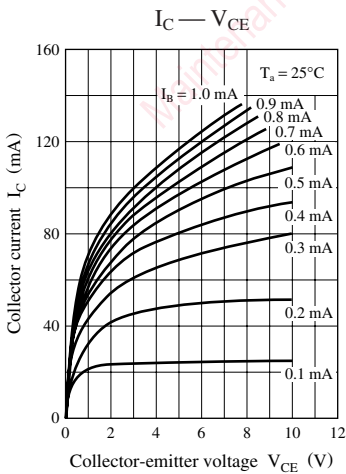

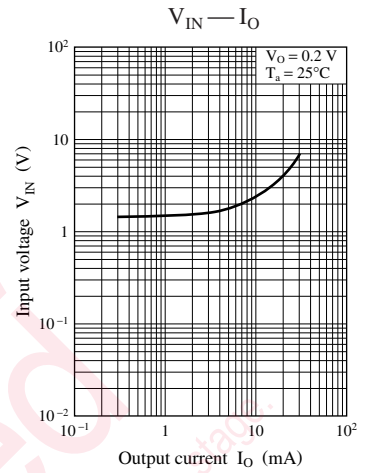
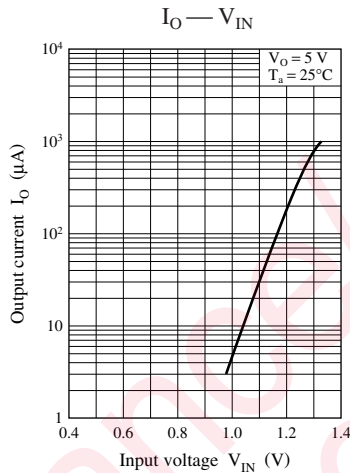
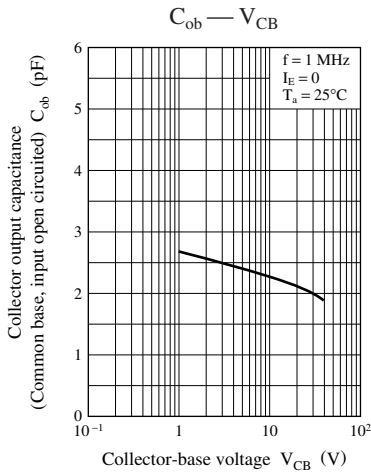

Characteristics charts of UNR9214G

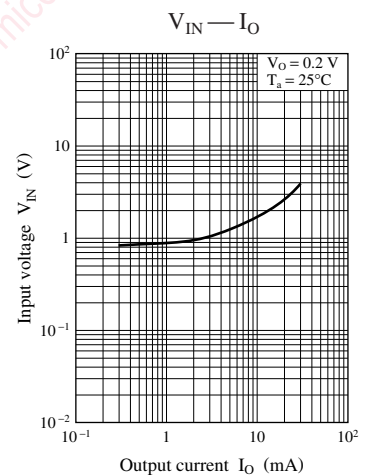
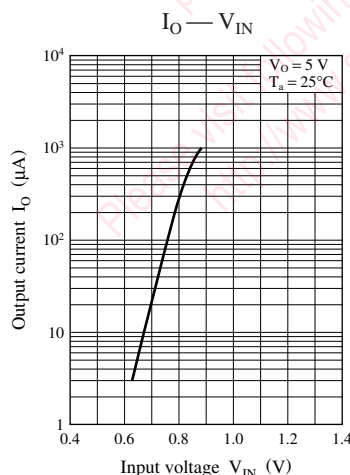
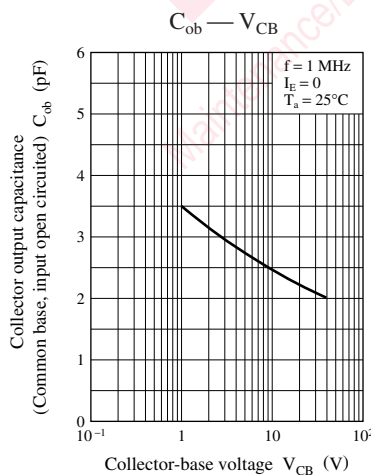
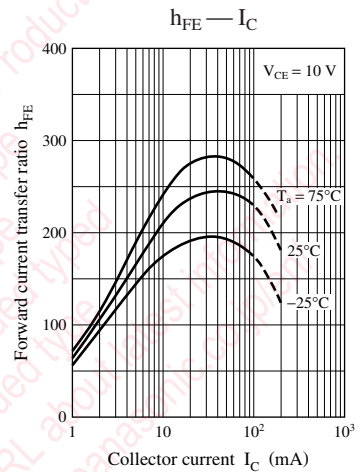
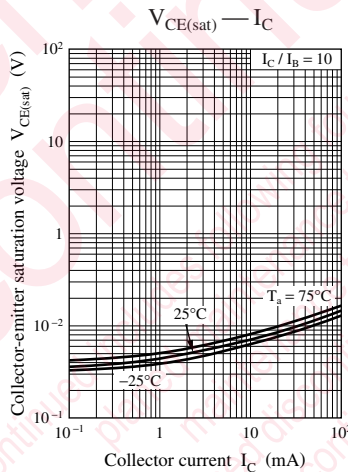
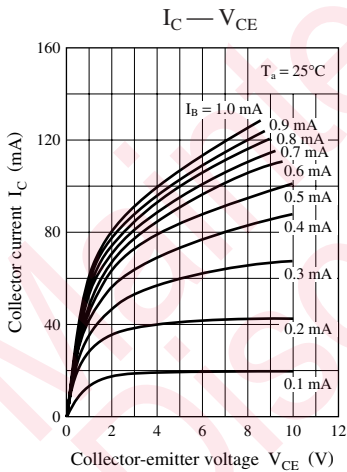

Characteristics charts of UNR9215G

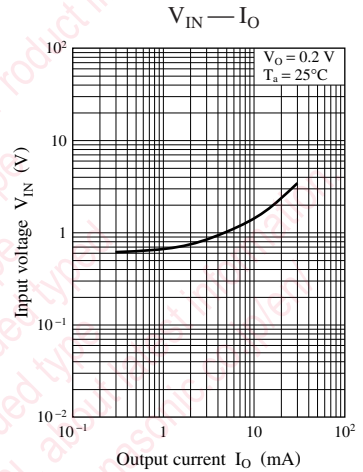
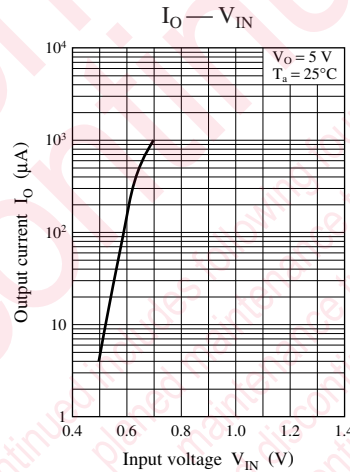
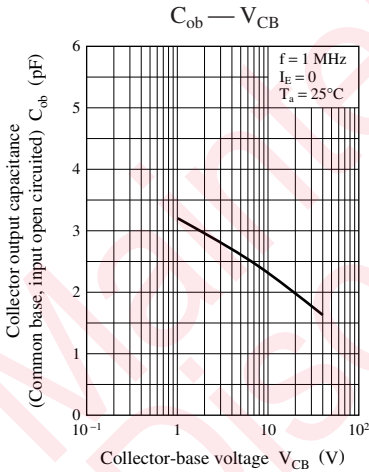
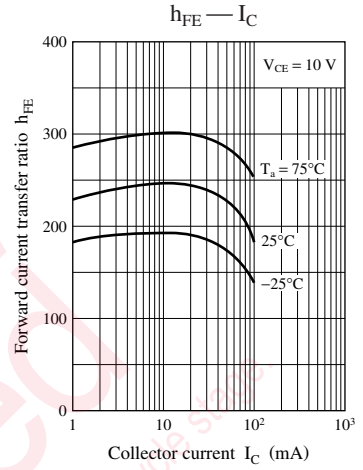
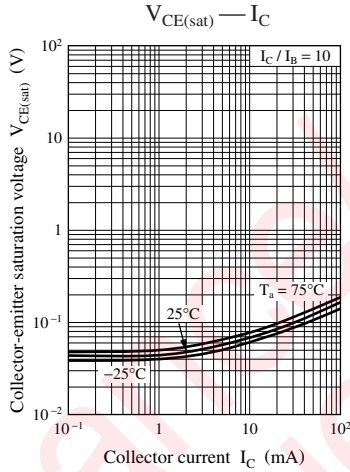
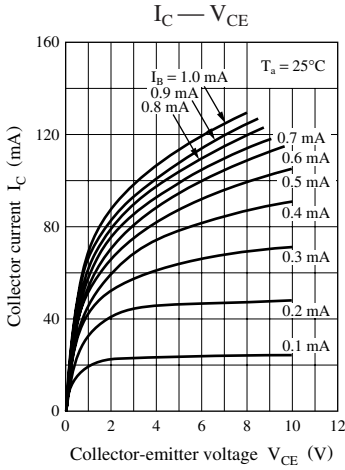

Characteristics charts of UNR9216G

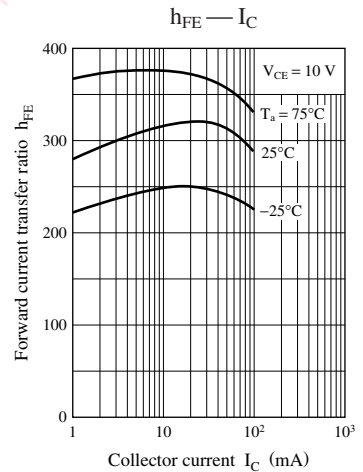
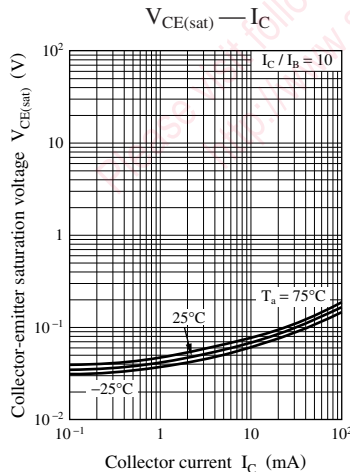
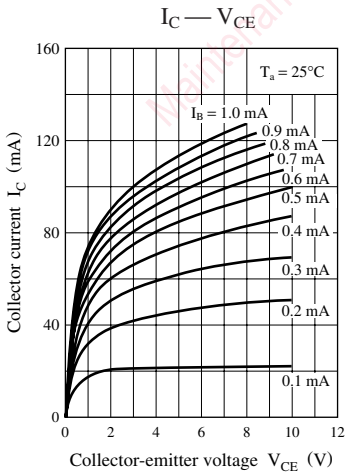



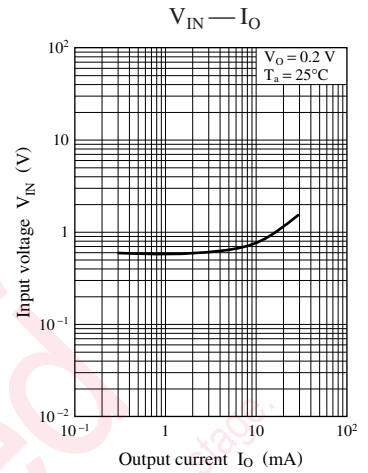
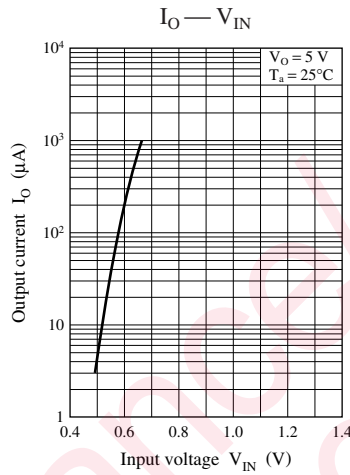
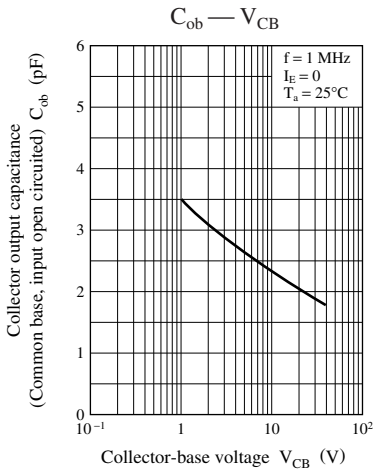

Characteristics charts of UNR9217G

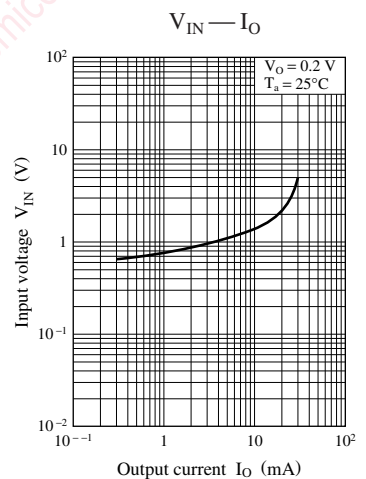
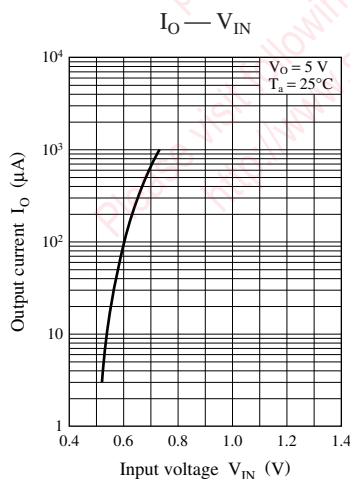
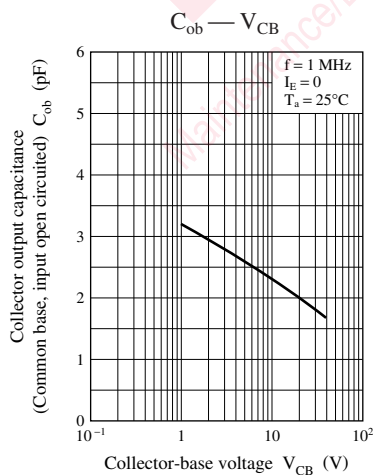
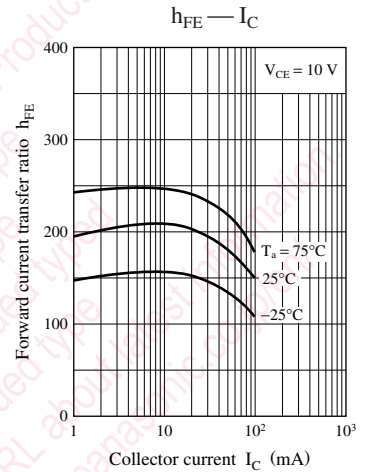
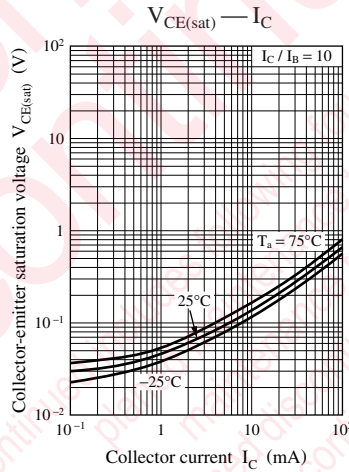
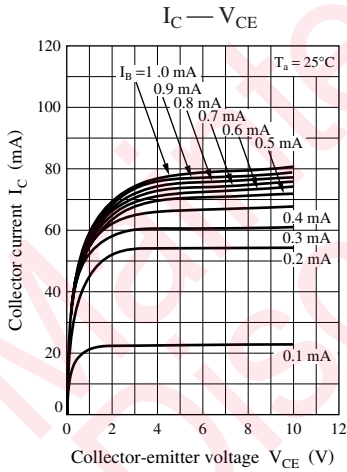



Characteristics charts of UNR9218G

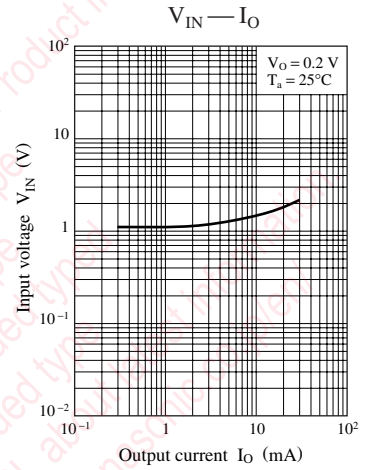
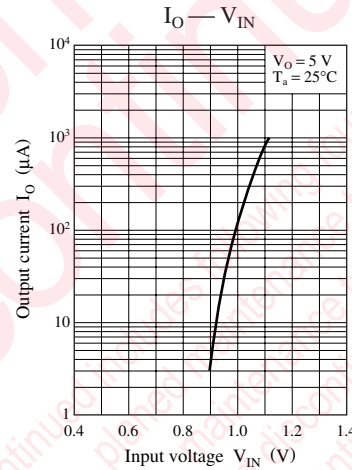
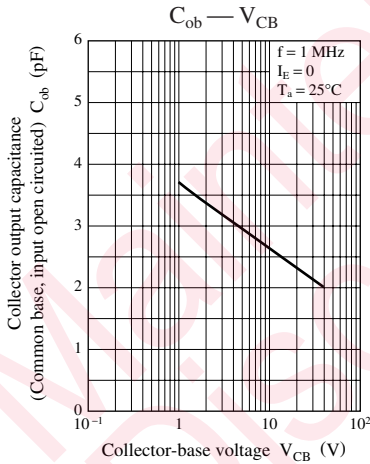
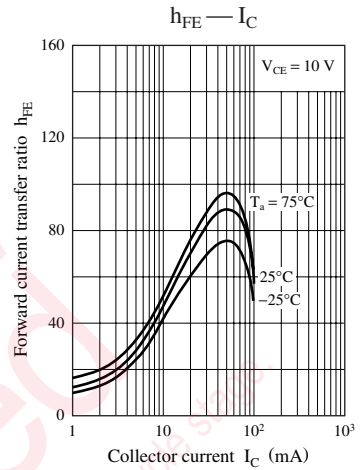
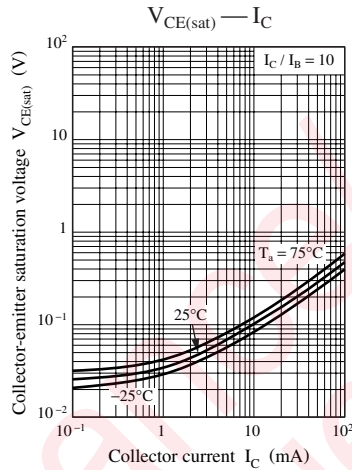
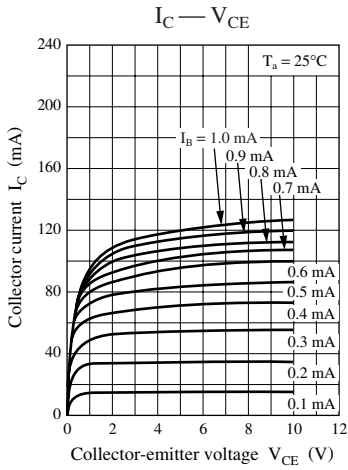

Characteristics charts of UNR9219G

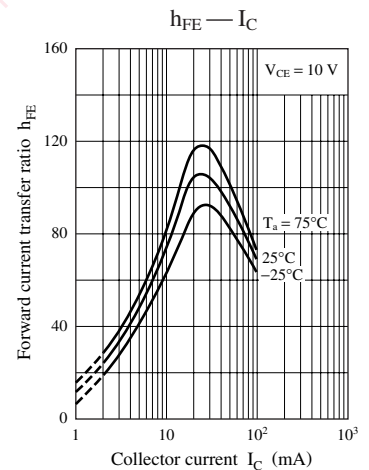
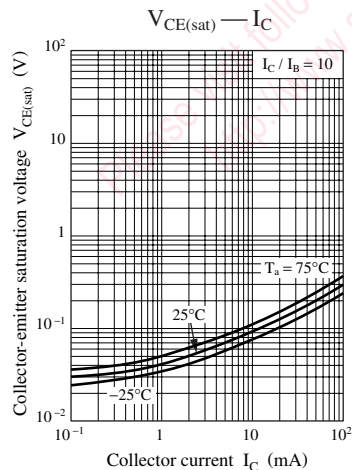
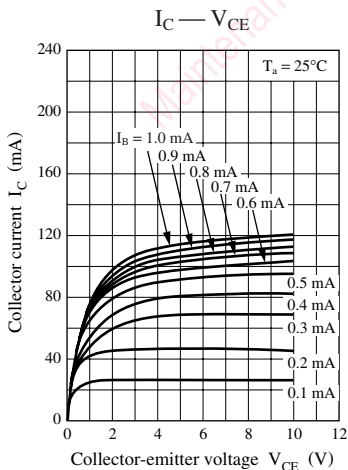

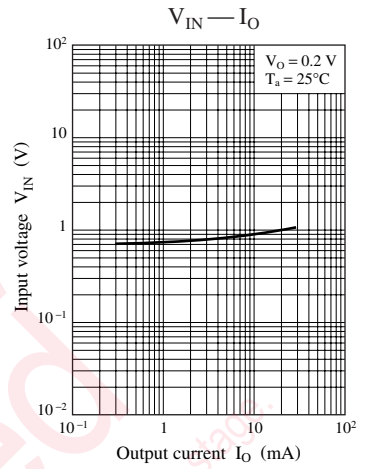
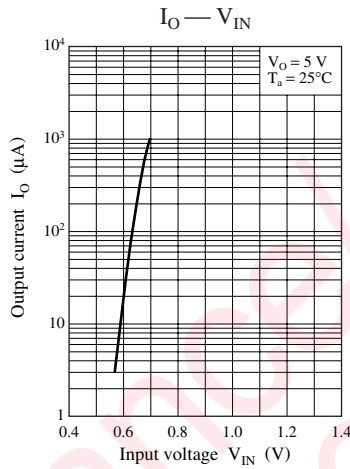
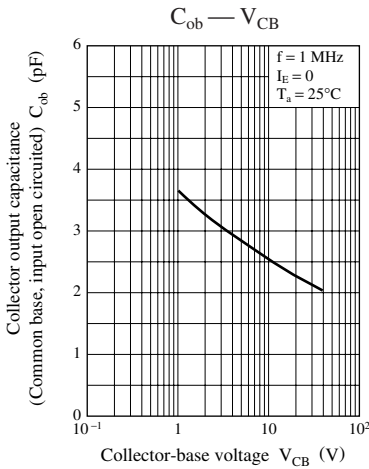

Characteristics charts of UNR921AG

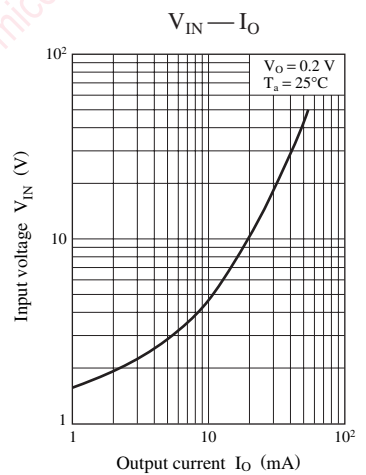
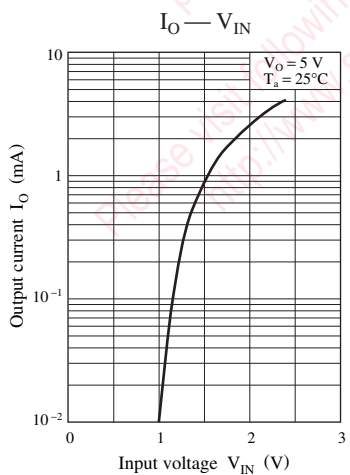
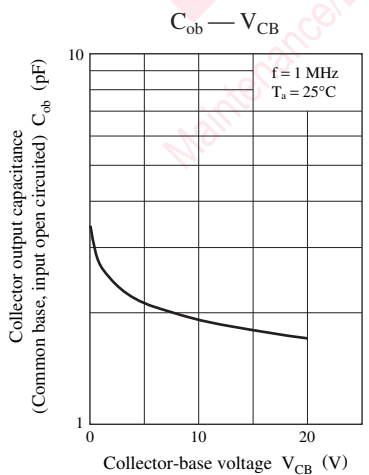
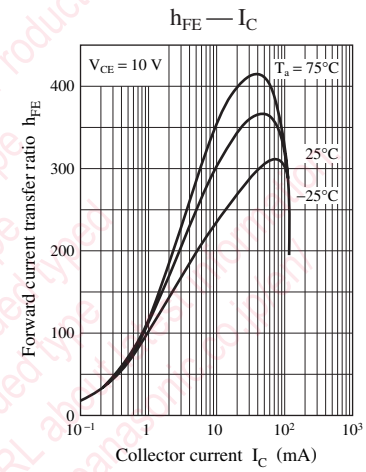
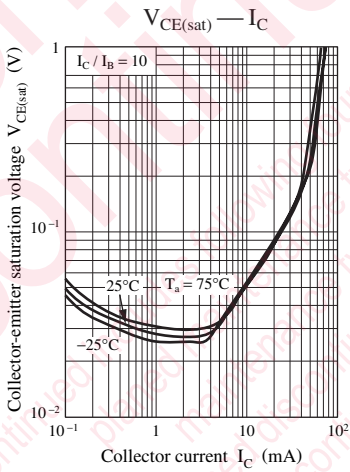
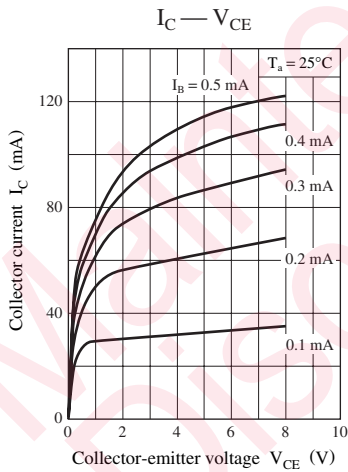

Characteristics charts of UNR921BG

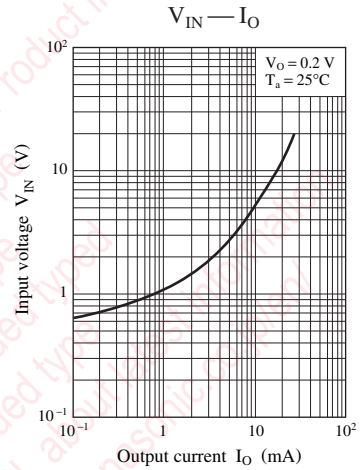
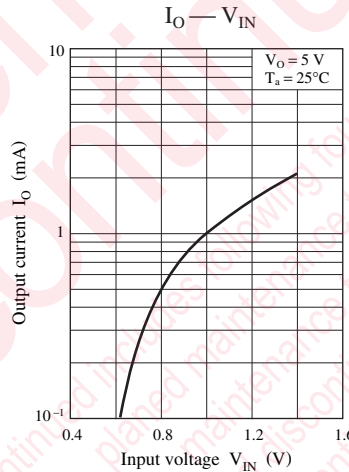
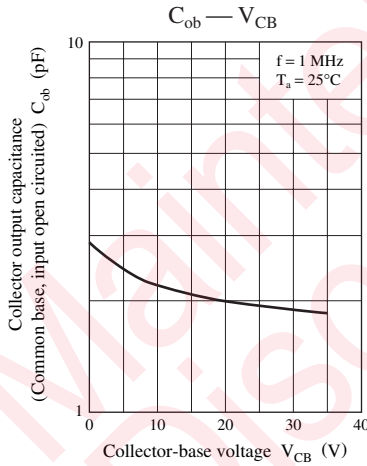
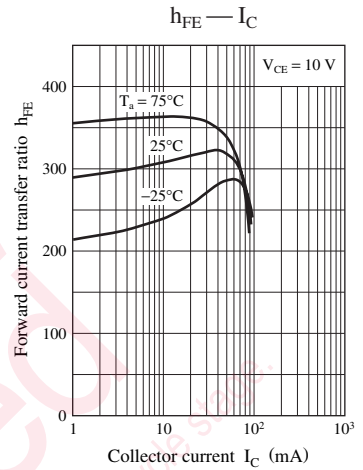
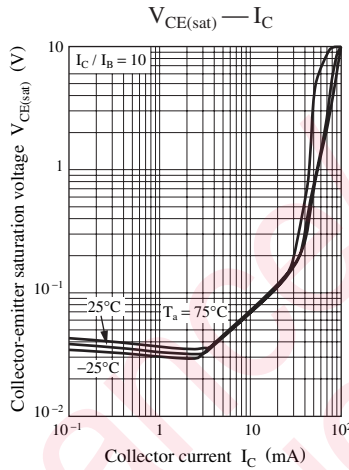
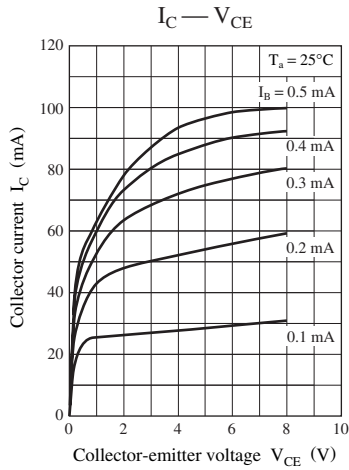

Characteristics charts of UNR921CG

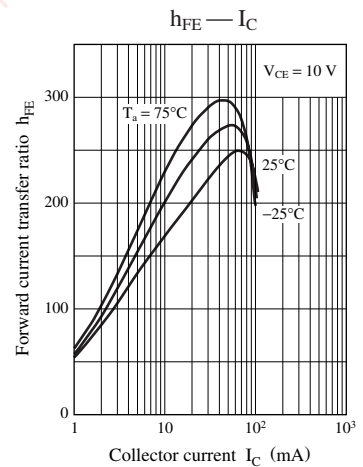
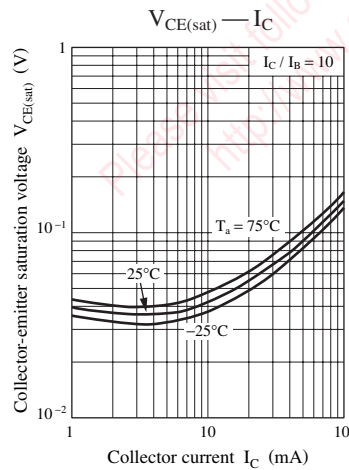
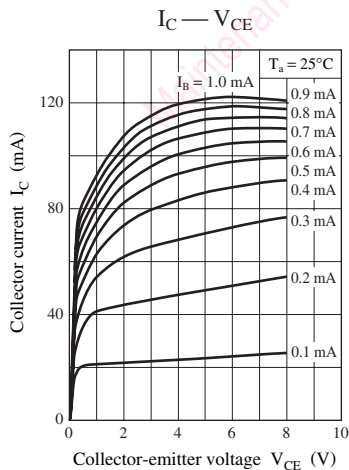

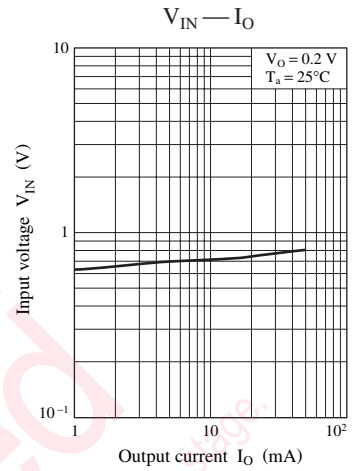
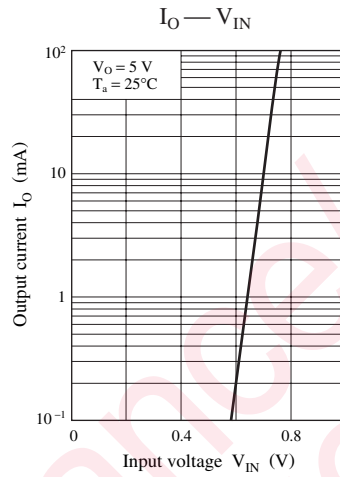
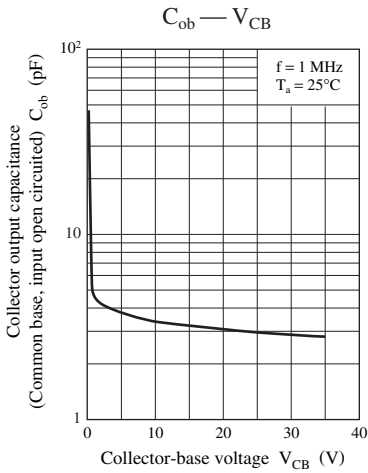

Characteristics charts of UNR921DG

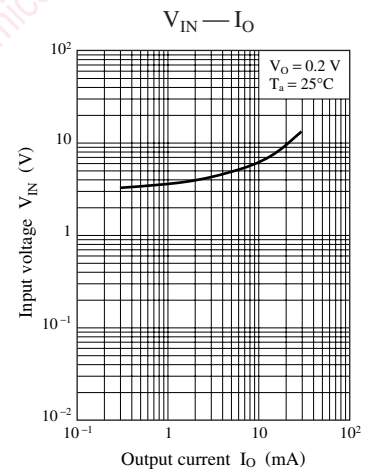
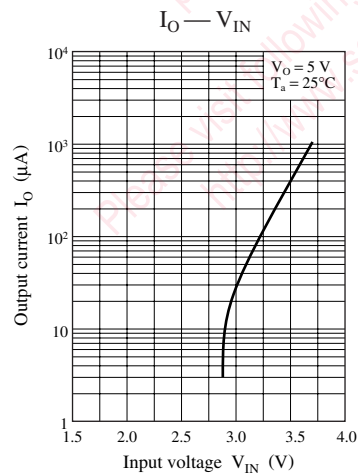
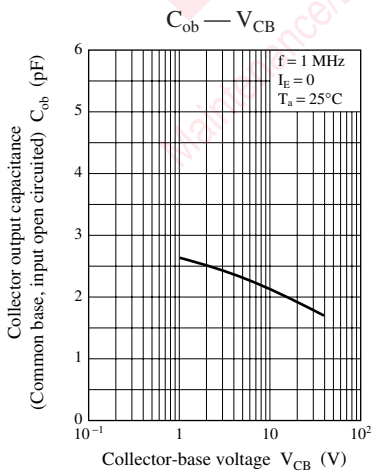
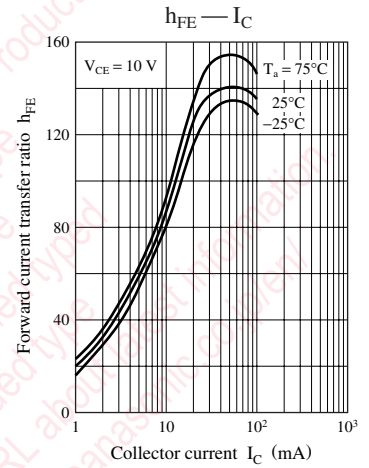
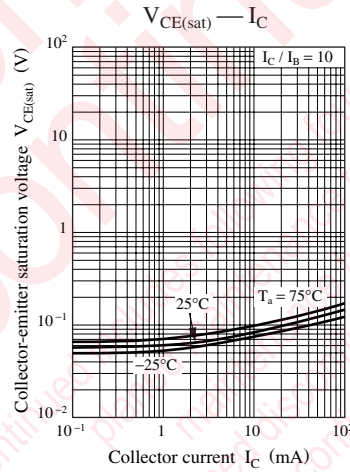
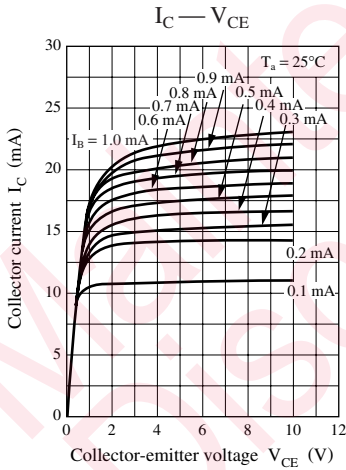

Characteristics charts of UNR921EG

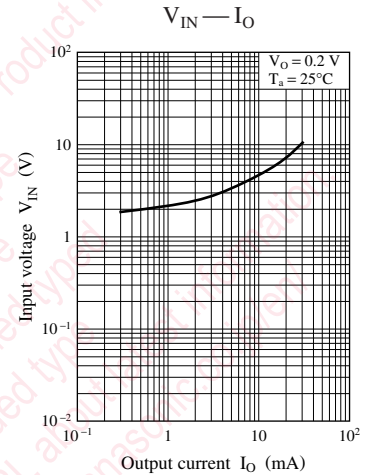
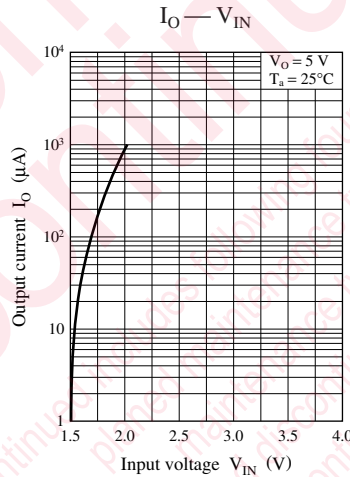
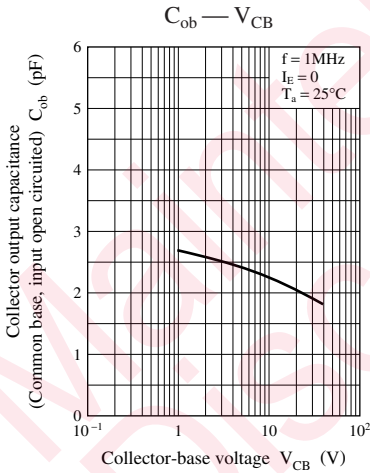
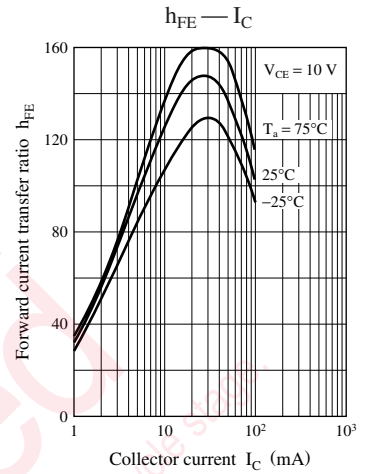
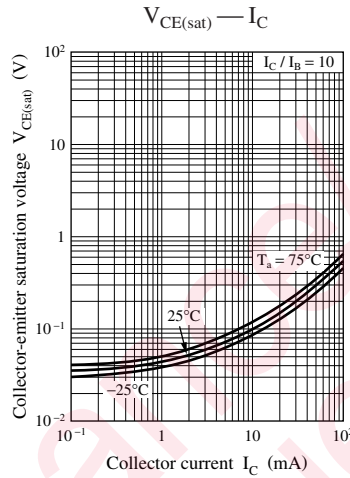
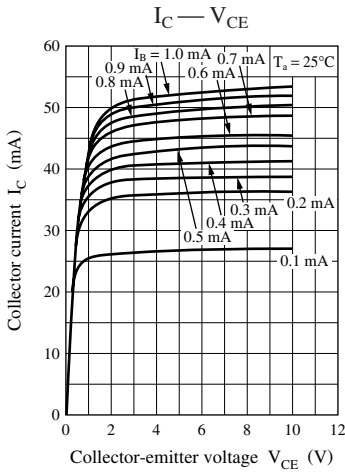

Characteristics charts of UNR921FG

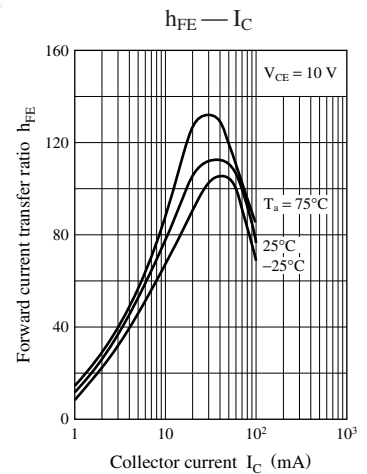
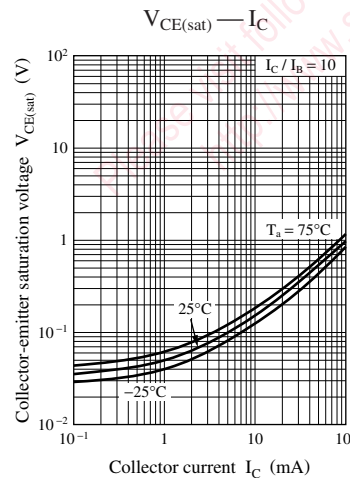
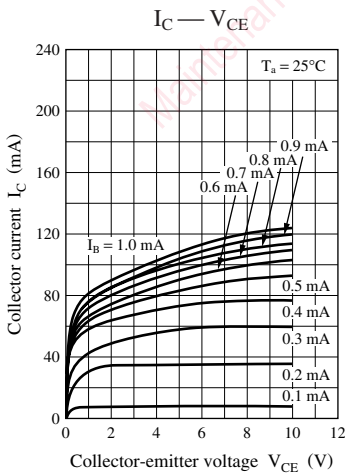

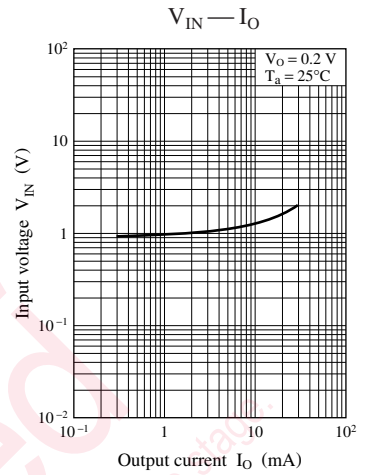
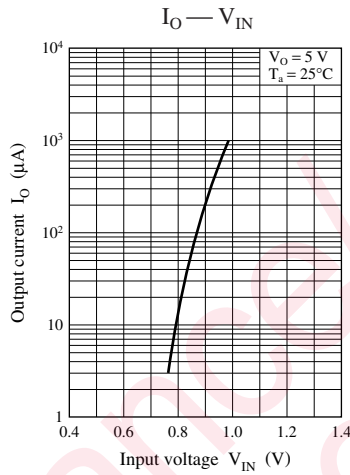
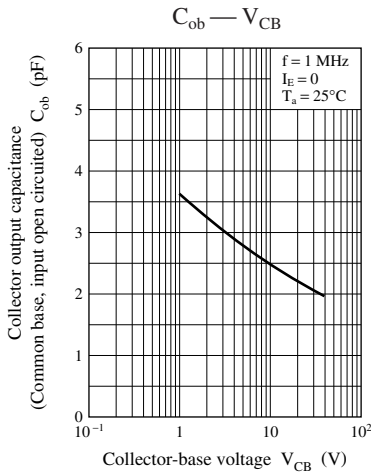

Characteristics charts of UNR921KG

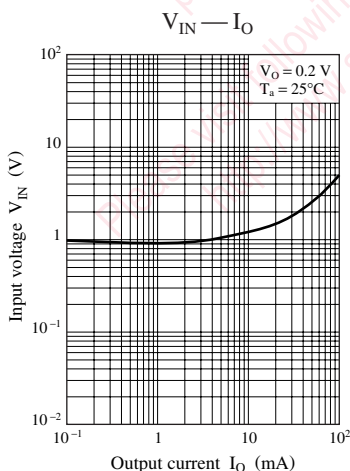
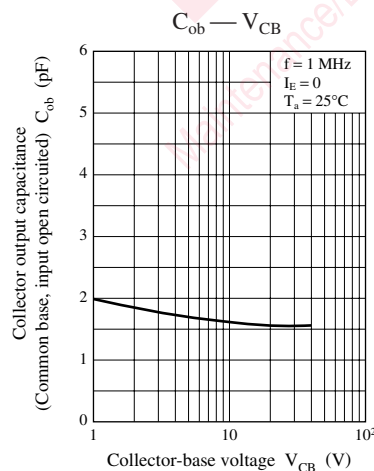
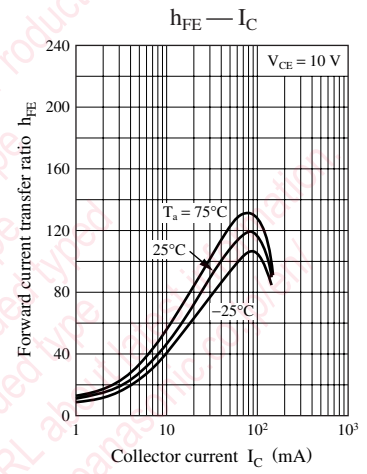
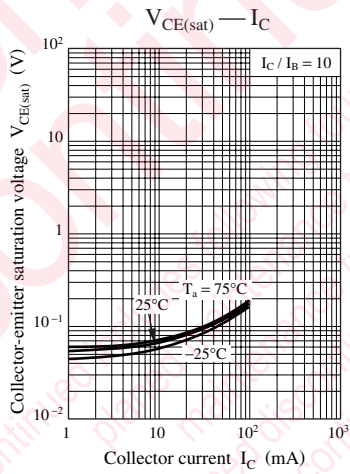
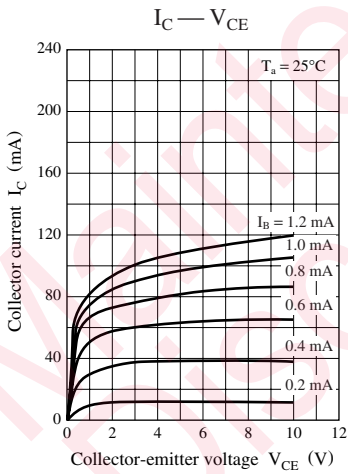

Characteristics charts of UNR921LG

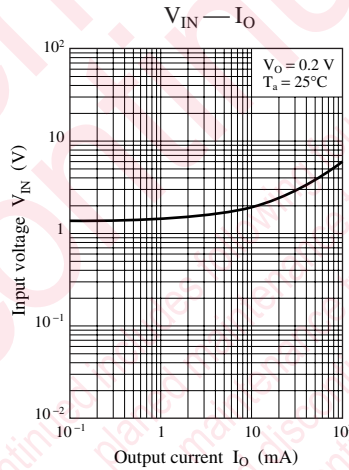
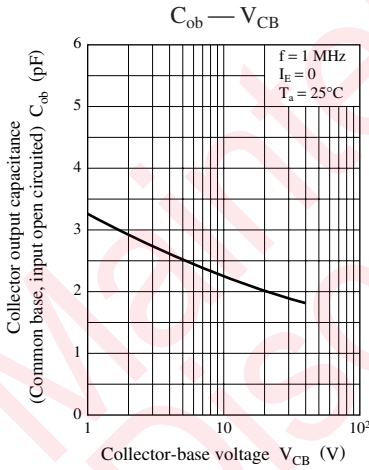
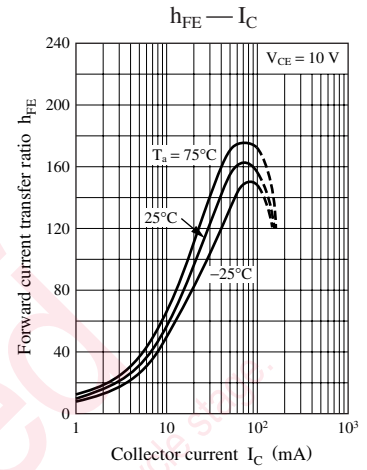
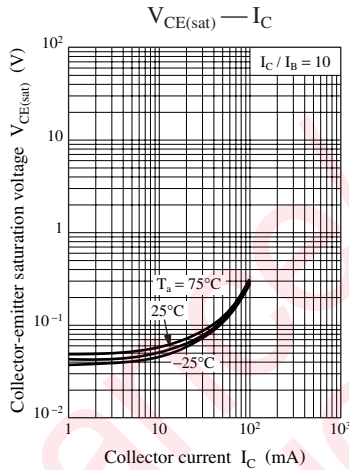
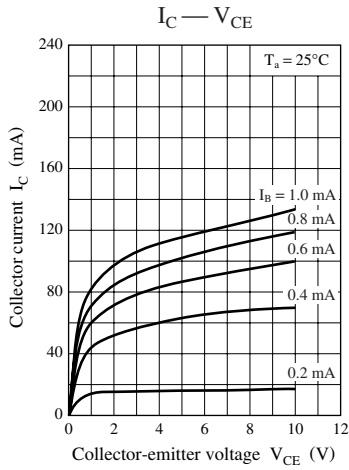

Characteristics charts of UNR921MG

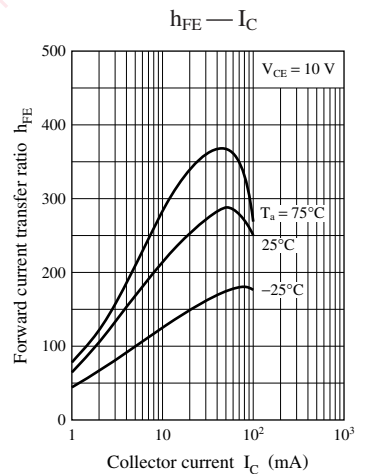
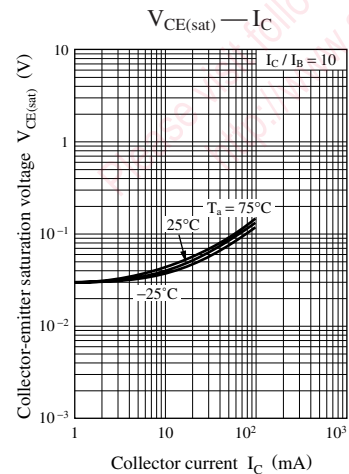
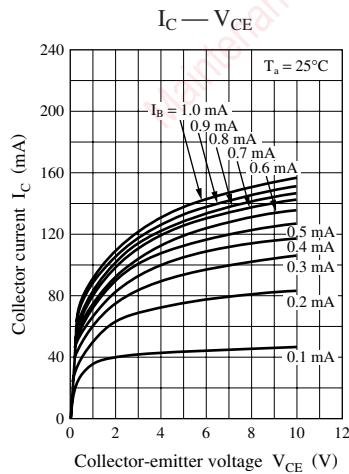



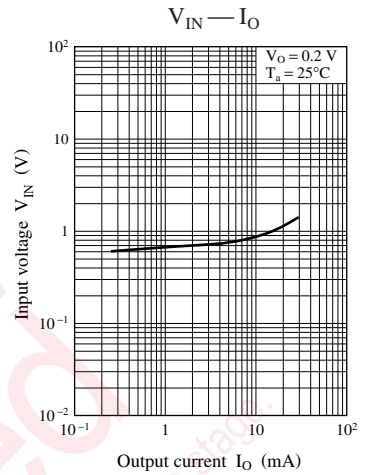
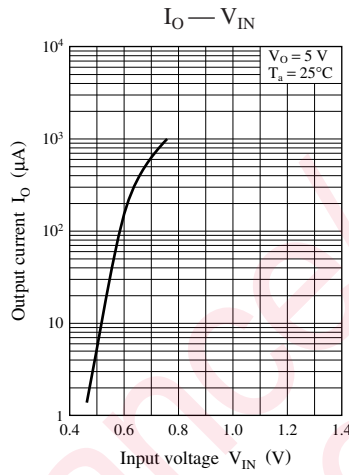
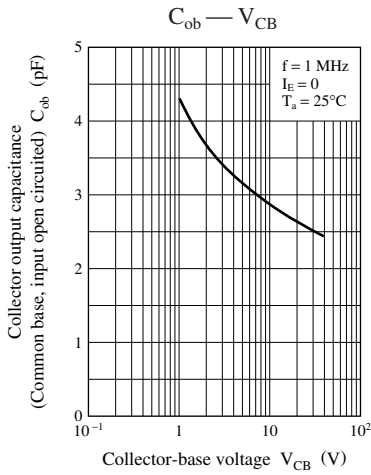

Characteristics charts of UNR921NG

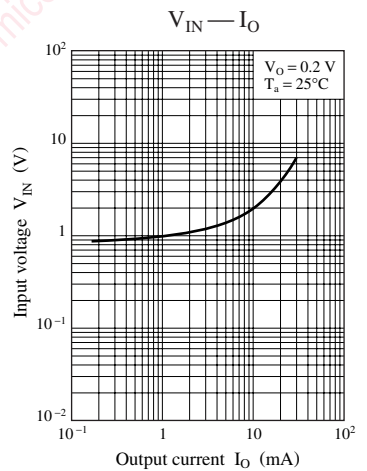
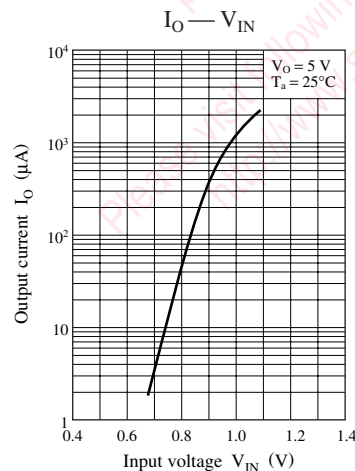
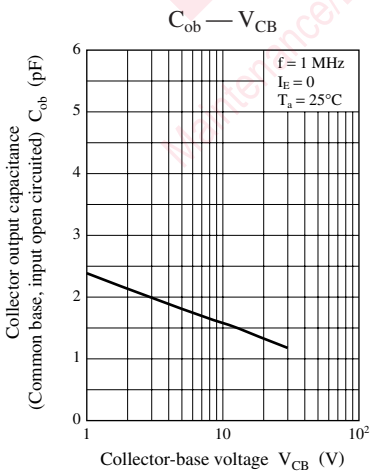
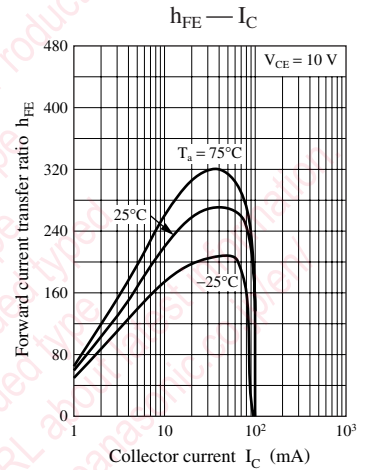
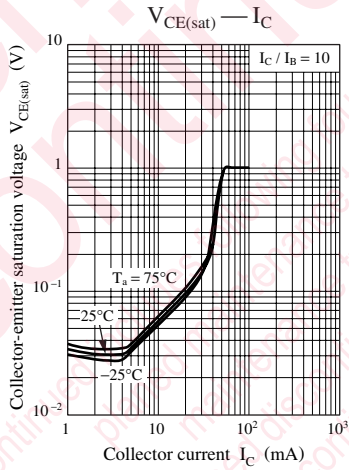
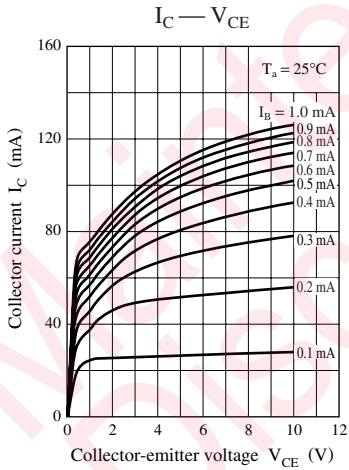

Characteristics charts of UNR921TG

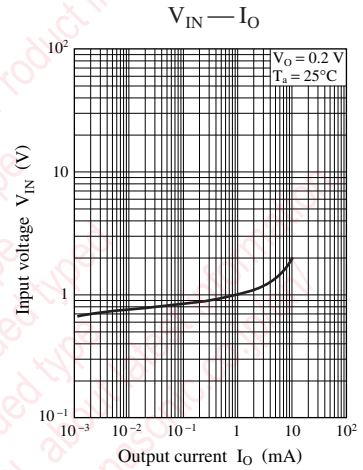
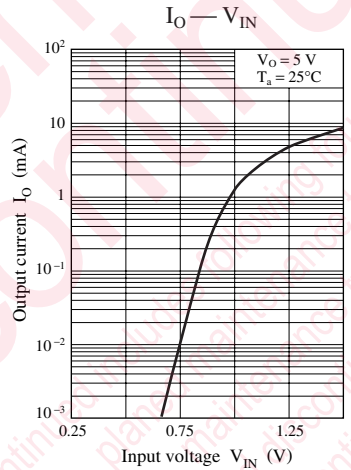
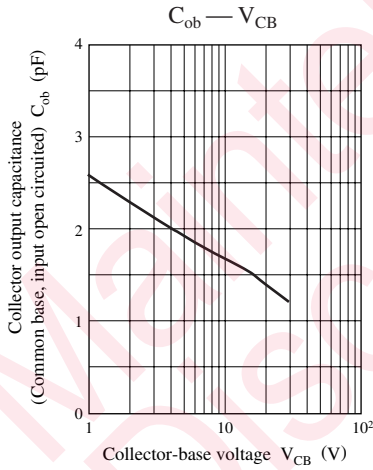
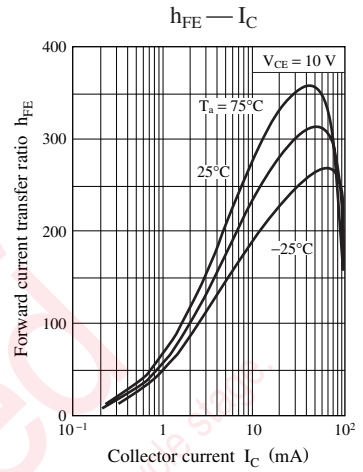
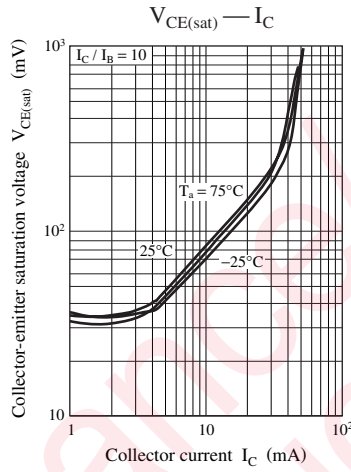
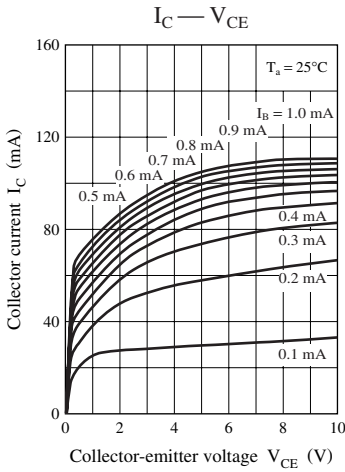

Characteristics charts of UNR921VG

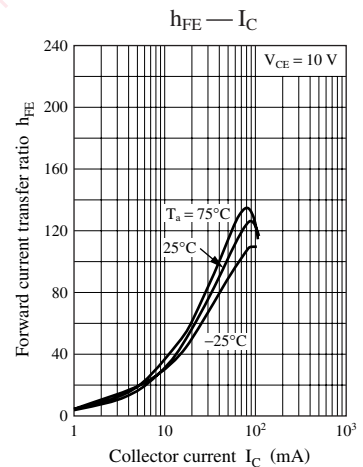
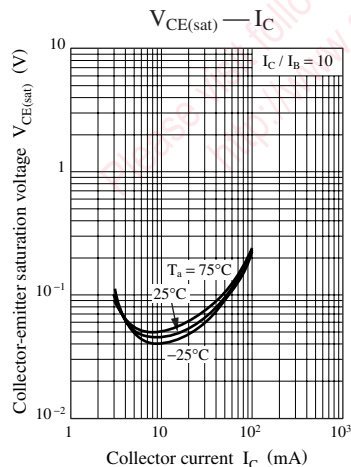
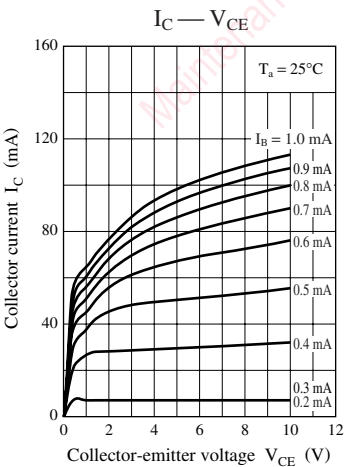

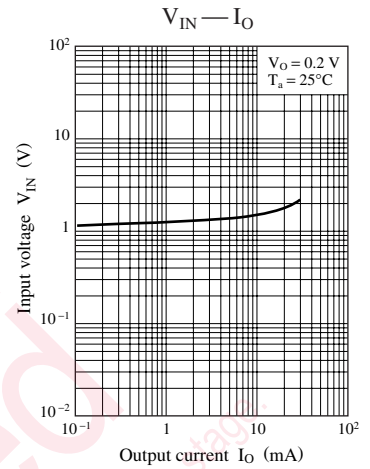
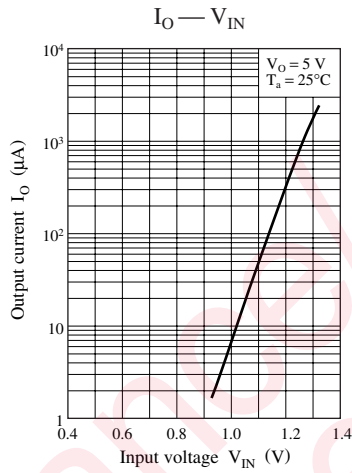
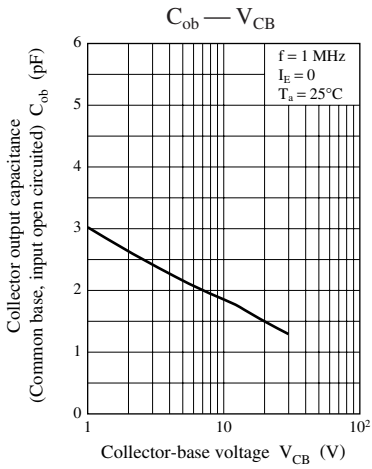

# SSMini3-F3

Unit: mm

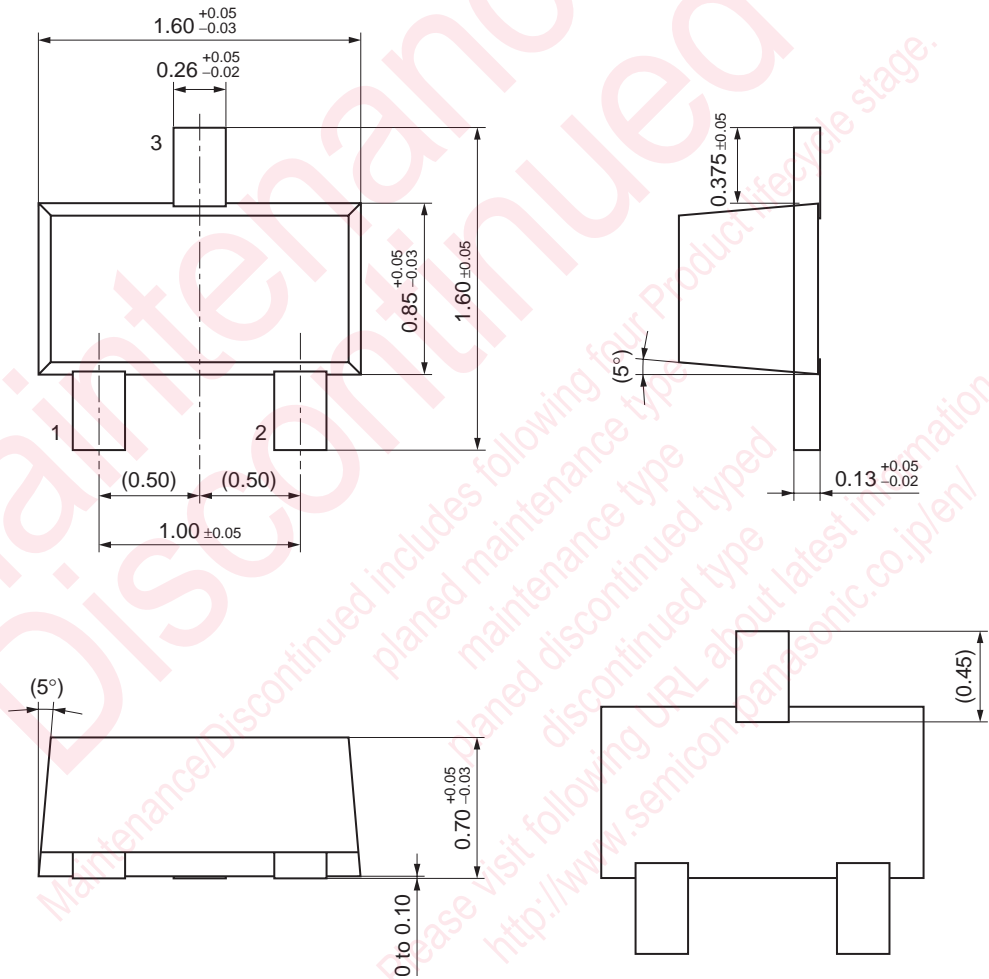

## Request for your special attention and precautions in using the technical information and semiconductors described in this book

- (1) If any of the products or technical information described in this book is to be exported or provided to non-residents, the laws and regulations of the exporting country, especially, those with regard to security export control, must be observed.
- (2) The technical information described in this book is intended only to show the main characteristics and application circuit examples of the products, and no license is granted under any intellectual property right or other right owned by our company or any other company. Therefore, no responsibility is assumed by our company as to the infringement upon any such right owned by any other company which may arise as a result of the use of technical information described in this book.
- (3) The products described in this book are intended to be used for standard applications or general electronic equipment (such as office equipment, communications equipment, measuring instruments and household appliances).  
Consult our sales staff in advance for information on the following applications:
  - Special applications (such as for airplanes, aerospace, automobiles, traffic control equipment, combustion equipment, life support systems and safety devices) in which exceptional quality and reliability are required, or if the failure or malfunction of the products may directly jeopardize life or harm the human body.
  - Any applications other than the standard applications intended.
- (4) The products and product specifications described in this book are subject to change without notice for modification and/or improvement. At the final stage of your design, purchasing, or use of the products, therefore, ask for the most up-to-date Product Standards in advance to make sure that the latest specifications satisfy your requirements.
- (5) When designing your equipment, comply with the range of absolute maximum rating and the guaranteed operating conditions (operating power supply voltage and operating environment etc.). Especially, please be careful not to exceed the range of absolute maximum rating on the transient state, such as power-on, power-off and mode-switching. Otherwise, we will not be liable for any defect which may arise later in your equipment.
  - Even when the products are used within the guaranteed values, take into the consideration of incidence of break down and failure mode, possible to occur to semiconductor products. Measures on the systems such as redundant design, arresting the spread of fire or preventing glitch are recommended in order to prevent physical injury, fire, social damages, for example, by using the products.
- (6) Comply with the instructions for use in order to prevent breakdown and characteristics change due to external factors (ESD, EOS, thermal stress and mechanical stress) at the time of handling, mounting or at customer's process. When using products for which damp-proof packing is required, satisfy the conditions, such as shelf life and the elapsed time since first opening the packages.
- (7) This book may be not reprinted or reproduced whether wholly or partially, without the prior written permission of Matsushita Electric Industrial Co., Ltd.