

verwendbarer Kabel- ϕ 4-5mm
 suitable cable ϕ 4-5mm

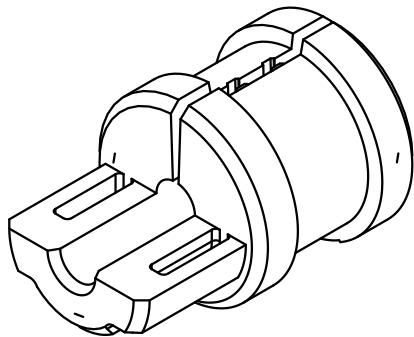

All Dimensions in mm Original Size DIN A 4		Techn. Character.			Nicht tolerierte Maß/Free size tolerances	
			Dat.	Name	Maßstab/Scale 2:1	Kabeldurchführungstülle Cable entry gland
		Detail.	07.03.12	Ho		
		Insp.		Be		
		Stand.				
A			HARTING Electric GmbH & Co. KG		TB 09 00 000 5352	Blatt/page
Mod.	Dat.	Name	D-32339 Espelkamp			