

EPC2024 – Enhancement Mode Power Transistor

 V_{DSS} , 40 V $R_{DS(on)}$, 1.5 mΩ I_D , 90 A

Gallium Nitride is grown on Silicon Wafers and processed using standard CMOS equipment leveraging the infrastructure that has been developed over the last 60 years. GaN's exceptionally high electron mobility allows very low $R_{DS(on)}$, while its lateral device structure and majority carrier diode provide exceptionally low Q_G and zero Q_{RR} . The end result is a device that can handle tasks where very high switching frequency, and low on-time are beneficial as well as those where on-state losses dominate.

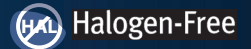
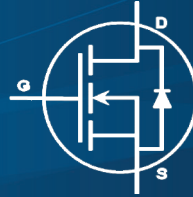
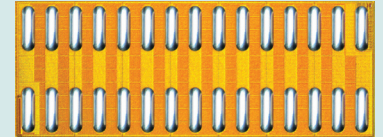

EPC2024 eGaN® FETs are supplied only in passivated die form with solder bumps
Die Size: 6.05 mm x 2.3 mm

Applications

- High Frequency DC-DC Conversion
- Motor Drive
- Industrial Automation
- Synchronous Rectification
- Inrush Protection
- Point-of-Load (POL) Converters

www.epc-co.com/epc/Products/eGaNfets/EPC2024.aspx

Maximum Ratings

Maximum Ratings			
V_{DS}	Drain-to-Source Voltage (Continuous)	40	V
	Drain-to-Source Voltage (up to 10,000 5 ms pulses at 150°C)	48	
I_D	Continuous ($T_A = 25^\circ\text{C}$, $R_{\theta JA} = 6^\circ\text{C/W}$)	90	A
	Pulsed (25°C , $T_{PULSE} = 300 \mu\text{s}$)	560	
V_{GS}	Gate-to-Source Voltage	6	V
	Gate-to-Source Voltage	-4	
T_J	Operating Temperature	-40 to 150	°C
T_{STG}	Storage Temperature	-40 to 150	

Static Characteristics ($T_J = 25^\circ\text{C}$ unless otherwise stated)

PARAMETER		TEST CONDITIONS	MIN	TYP	MAX	UNIT
BV_{DSS}	Drain-to-Source Voltage	$V_{GS} = 0\text{ V}$, $I_D = 1.1\text{ mA}$	40			V
I_{DSS}	Drain Source Leakage	$V_{DS} = 32\text{ V}$, $V_{GS} = 0\text{ V}$		0.1	0.9	mA
I_{GSS}	Gate-to-Source Forward Leakage	$V_{GS} = 5\text{ V}$		1	9	mA
	Gate-to-Source Reverse Leakage	$V_{GS} = -4\text{ V}$		0.1	0.9	mA
$V_{GS(TH)}$	Gate Threshold Voltage	$V_{DS} = V_{GS}$, $I_D = 19\text{ mA}$	0.8	1.4	2.5	V
$R_{DS(on)}$	Drain-Source on Resistance	$V_{GS} = 5\text{ V}$, $I_D = 37\text{ A}$		1.2	1.5	mΩ
V_{SD}	Source-Drain Forward Voltage	$I_S = 0.5\text{ A}$, $V_{GS} = 0\text{ V}$		1.8		V

All measurements were done with substrate shorted to source.

Thermal Characteristics

		TYP	UNIT
$R_{\theta JC}$	Thermal Resistance, Junction to Case	0.4	°C/W
$R_{\theta JB}$	Thermal Resistance, Junction to Board	1.1	°C/W
$R_{\theta JA}$	Thermal Resistance, Junction to Ambient (Note 1)	42	°C/W

Note 1: $R_{\theta JA}$ is determined with the device mounted on one square inch of copper pad, single layer 2 oz copper on FR4 board.
See http://epc-co.com/epc/documents/product-training/Appnote_Thermal_Performance_of_eGaN_FETs.pdf for details.

Dynamic Characteristics (T _J = 25°C unless otherwise stated)						
PARAMETER		TEST CONDITIONS	MIN	TYP	MAX	UNIT
C _{ISS}	Input Capacitance	V _{DS} = 20 V, V _{GS} = 0 V		1920	2300	pF
C _{RSS}	Reverse Transfer Capacitance			29		
C _{OSS}	Output Capacitance			1620	2430	
C _{OSS(ER)}	Effective Output Capacitance Energy Related (Note 2)	V _{DS} = 0 to 20 V, V _{GS} = 0 V		2050		
C _{OSS(TR)}	Effective Output Capacitance, Time Related (Note 3)			2240		
R _G	Gate Resistance			0.3		Ω
Q _G	Total Gate Charge	V _{DS} = 20 V, V _{GS} = 5 V, I _D = 37 A		18	24	nC
Q _{GS}	Gate-to-Source Charge	V _{DS} = 20 V, I _D = 37 A		5.1		
Q _{GD}	Gate-to-Drain Charge			2.4		
Q _{G(TH)}	Gate Charge at Threshold			3.8		
Q _{OSS}	Output Charge	V _{DS} = 20 V, V _{GS} = 0 V		45	68	
Q _{RR}	Source-Drain Recovery Charge			0		

Note 2: C_{OSS(ER)} is a fixed capacitance that gives the same stored energy as C_{OSS} while V_{DS} is rising from 0 to 50% BV_{DSS}.

Note 3: C_{OSS(TR)} is a fixed capacitance that gives the same charging time as C_{OSS} while V_{DS} is rising from 0 to 50% BV_{DSS}.

Figure 1: Typical Output Characteristics at 25°C

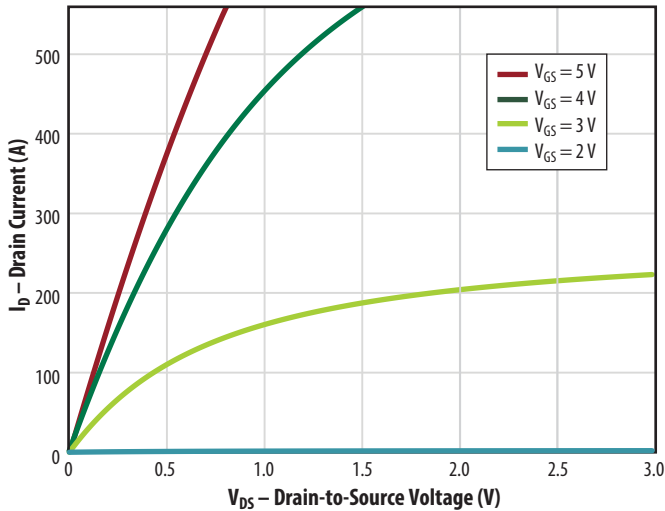

Figure 2: Transfer Characteristics

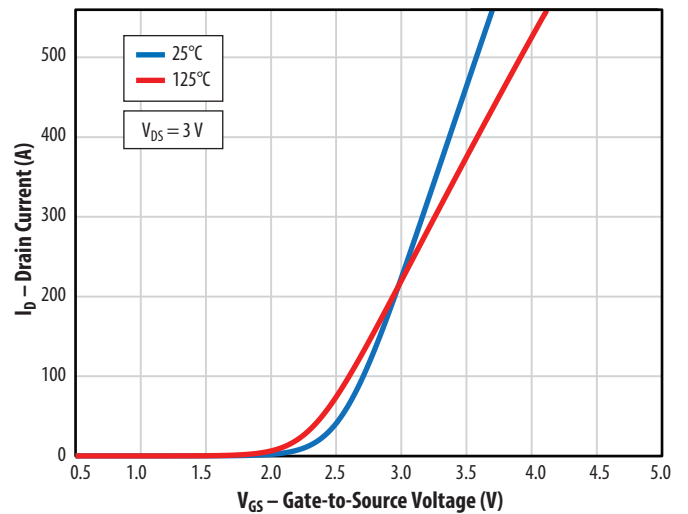

Figure 3: R_{DS(on)} vs. V_{GS} for Various Drain Currents

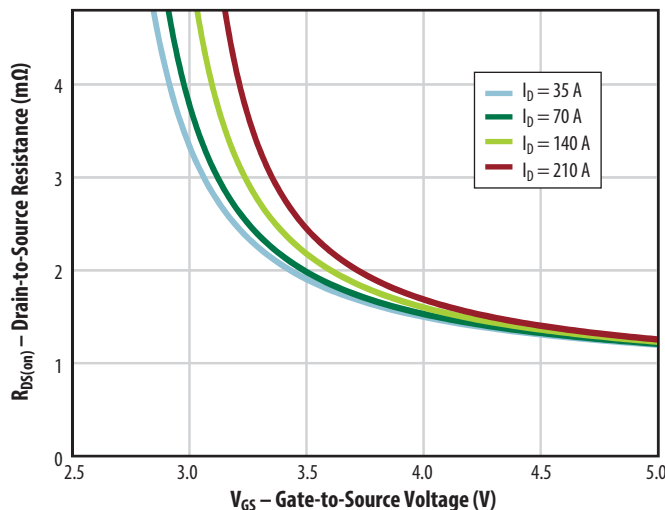

Figure 4: R_{DS(on)} vs. V_{GS} for Various Temperatures

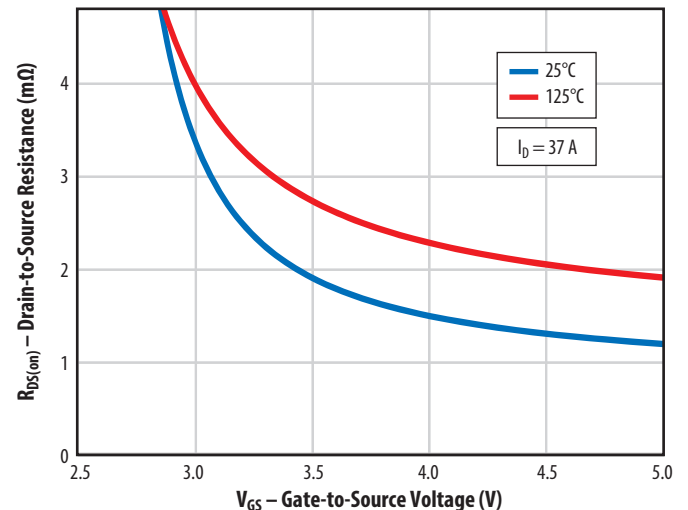

Figure 5a: Capacitance (Linear Scale)

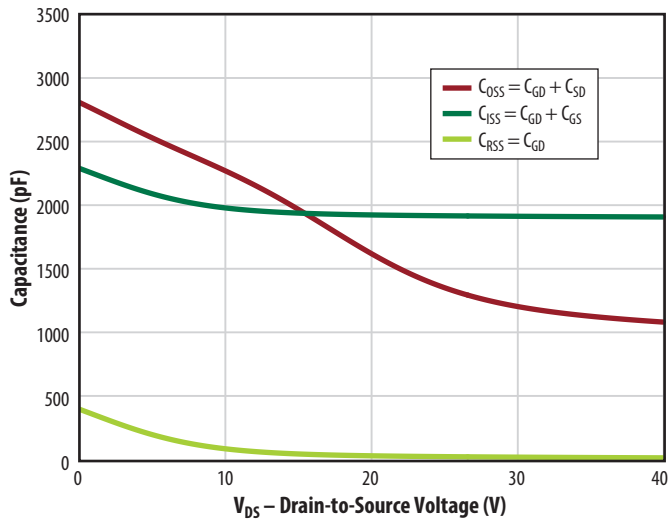

Figure 5b: Capacitance (Log Scale)

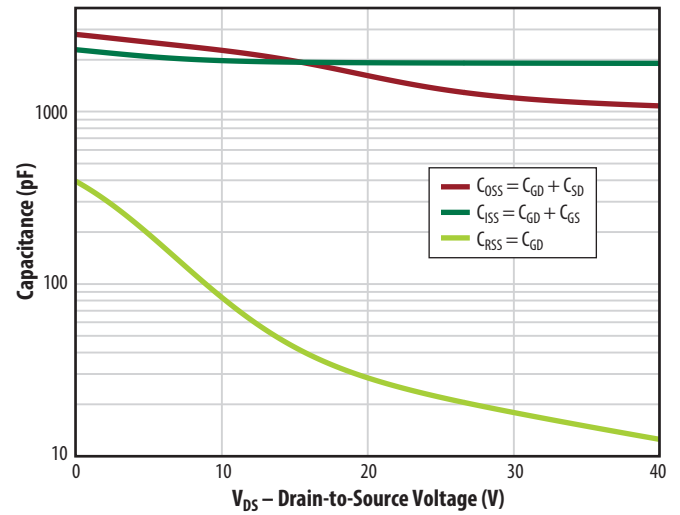

Figure 6: Gate Charge

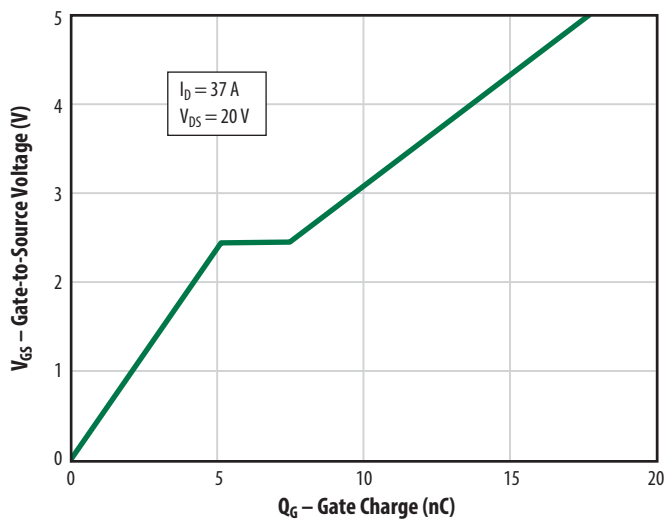

Figure 7: Reverse Drain-Source Characteristics

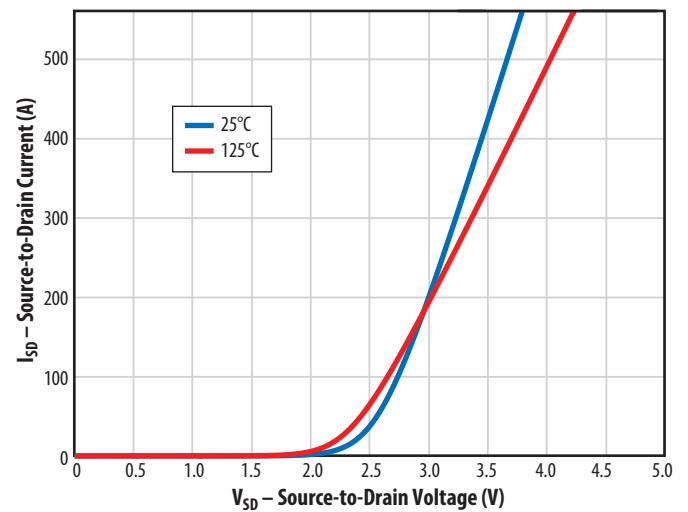

Figure 8: Normalized On-State Resistance vs. Temperature

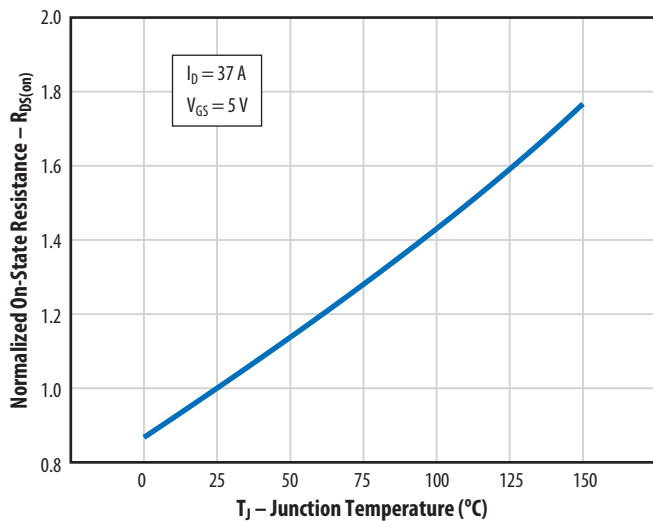
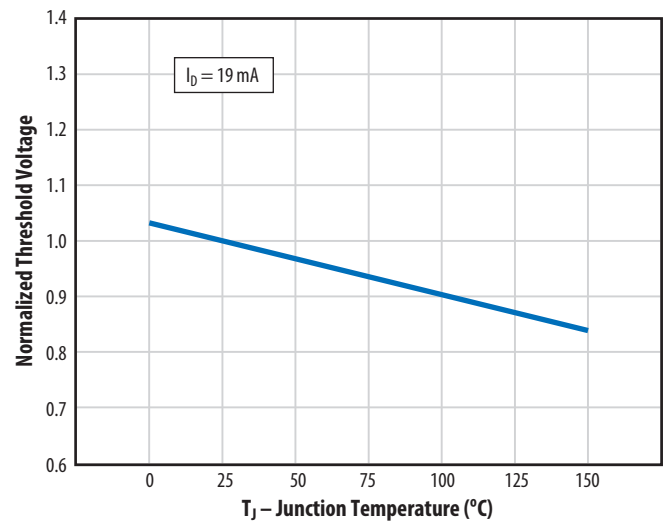

Figure 9: Normalized Threshold Voltage vs. Temperature



All measurements were done with substrate shorted to source. $T_J = 25^\circ\text{C}$ unless otherwise stated

Figure 10: Gate Leakage Current

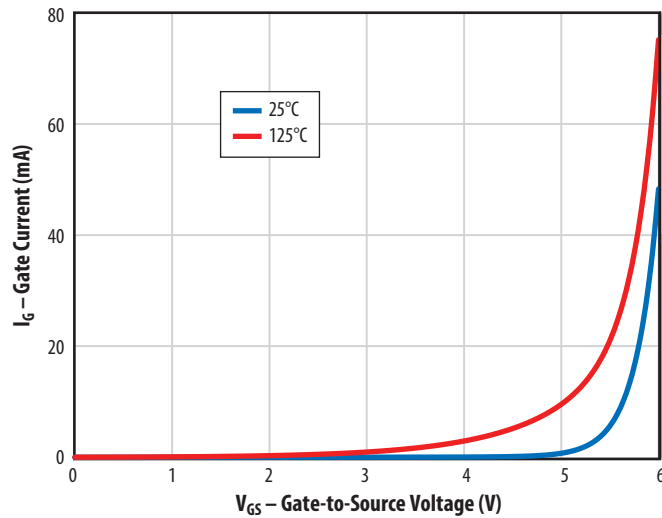

Figure 11: Transient Thermal Response Curves

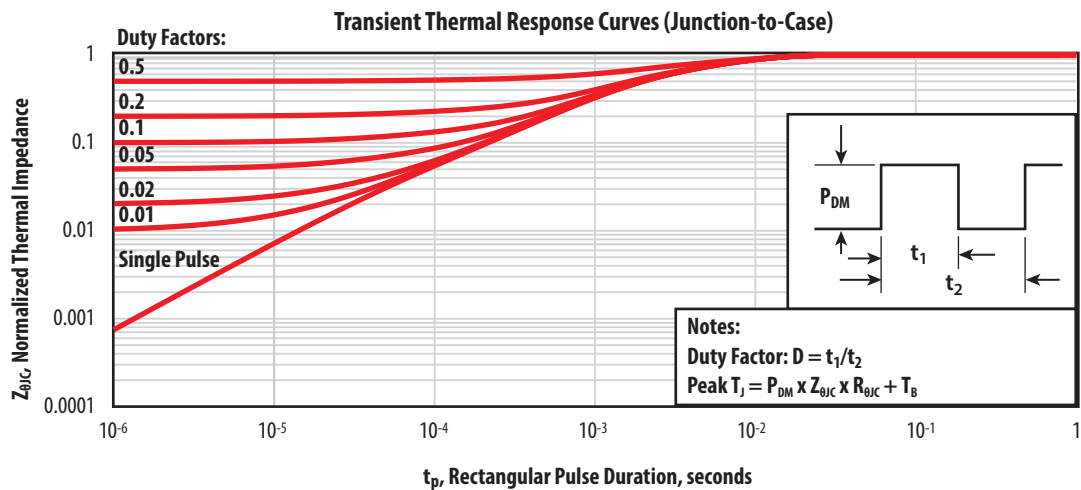
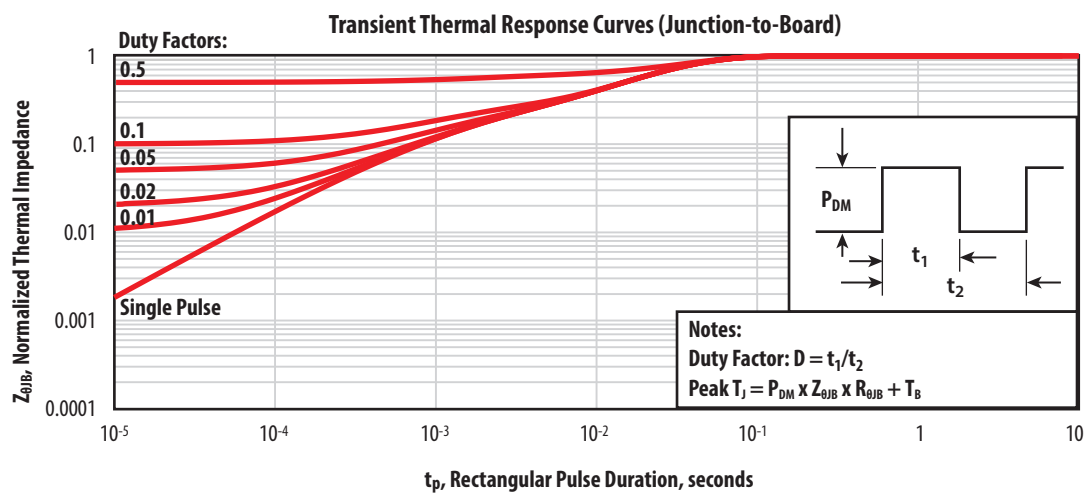
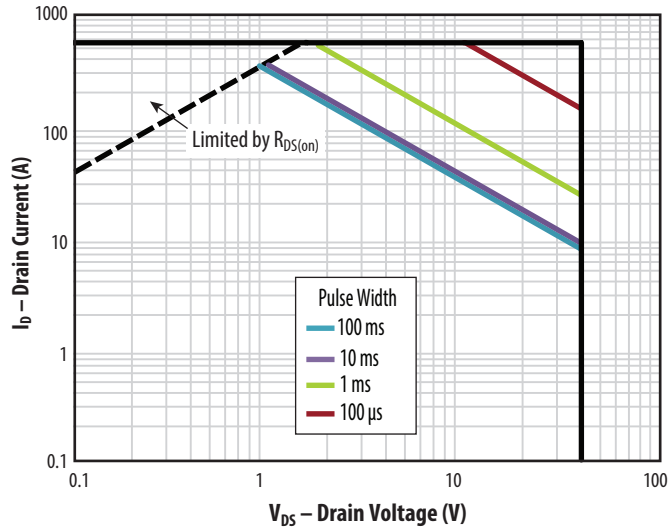
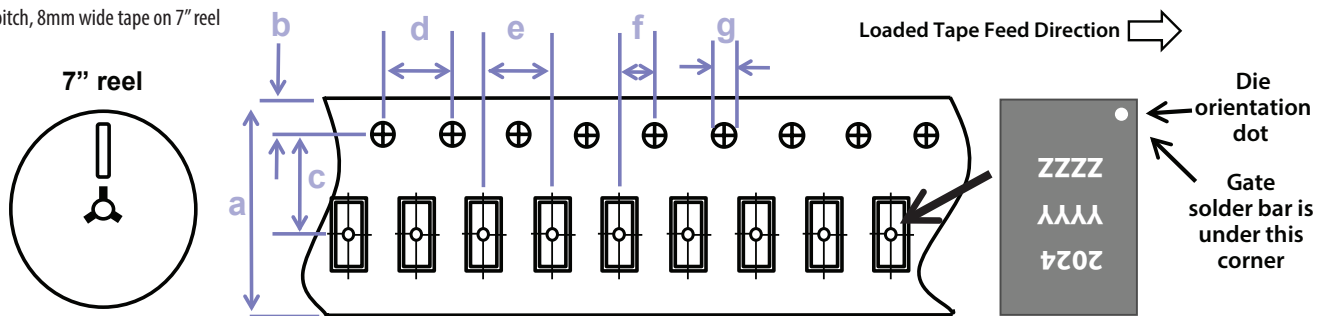

Figure 12: Safe Operating Area



TAPE AND REEL CONFIGURATION

4mm pitch, 8mm wide tape on 7" reel



Dimension (mm)	EPC2024 (note 1)		
	target	min	max
a	12.00	11.70	12.30
b	1.75	1.65	1.85
c (see note)	5.50	5.45	5.55
d	4.00	3.90	4.10
e	4.00	3.90	4.10
f (see note)	2.00	1.95	2.05
g	1.50	1.50	1.60

Die is placed into pocket solder bar side down (face side down)

Note 1: MSL 1 (moisture sensitivity level 1) classified according to IPC/JEDEC industry standard.
 Note 2: Pocket position is relative to the sprocket hole measured as true position of the pocket, not the pocket hole.

DIE MARKINGS

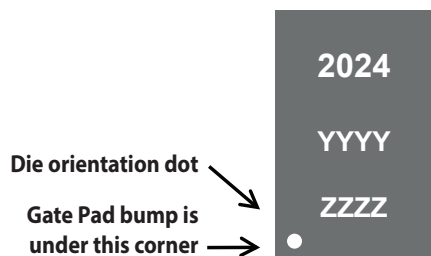

Part Number	Laser Marking		
	Part # Marking Line 1	Lot_Date Code Marking Line 2	Lot_Date Code Marking Line 3
EPC2024	2024	YYYY	ZZZZ

DIE OUTLINE

Solder Bar View

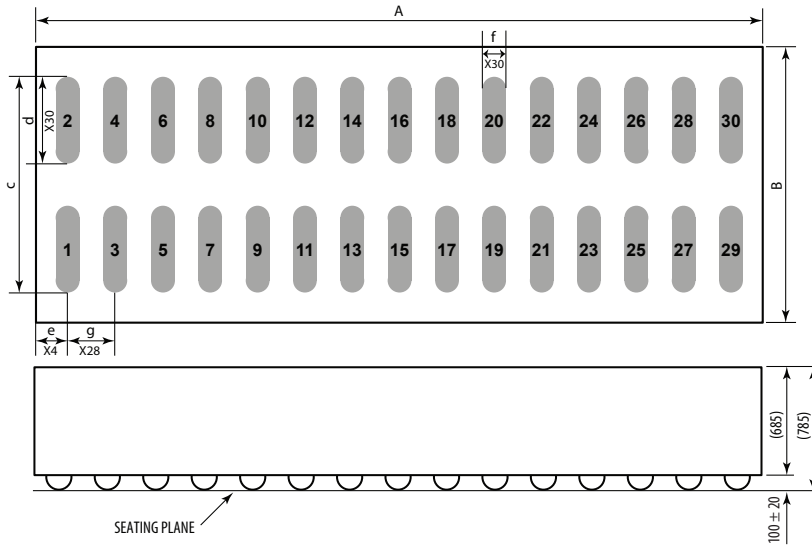

DIM	Micrometers		
	MIN	Nominal	MAX
A	6020	6050	6080
B	2270	2300	2330
c	2047	2050	2053
d	717	720	723
e	210	225	240
f	195	200	205
g	400	400	400

RECOMMENDED LAND PATTERN

(measurements in μm)

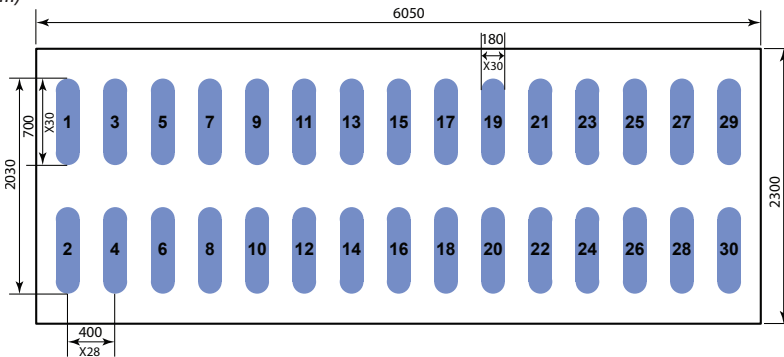

Land pattern is solder mask defined
Solder mask opening is 180 μm
It is recommended to have on-Cu trace PCB vias

- Pad no. 1 is Gate
- Pads no. 2,5,6,9,10,13,14,17,18,21,22, 25,26,29 are Source
- Pads no. 3,4,7,8,11,12,15,16,19,20,23, 24,27,28 are Drain
- Pad no. 30 is Substrate

RECOMMENDED STENCIL DRAWING

(measurements in μm)

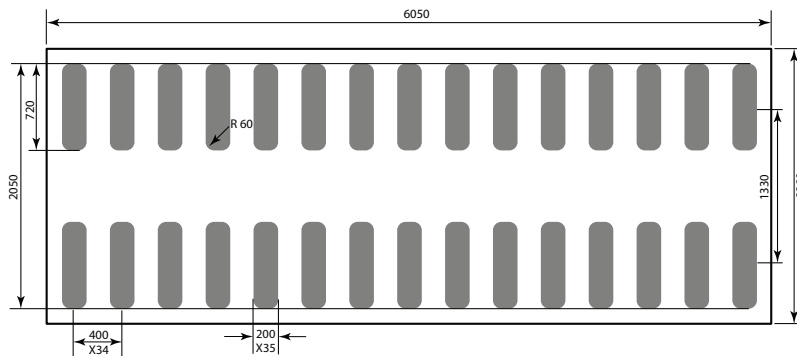

Recommended stencil should be 4 mil (100 μm) thick, must be laser cut, openings per drawing.

Intended for use with SAC305 Type 3 solder, reference 88.5% metals content.

Additional assembly resources available at <http://epc-co.com/epc/DesignSupport/AssemblyBasics.aspx>

Efficient Power Conversion Corporation (EPC) reserves the right to make changes without further notice to any products herein to improve reliability, function or design. EPC does not assume any liability arising out of the application or use of any product or circuit described herein; neither does it convey any license under its patent rights, nor the rights of others.

eGaN® is a registered trademark of Efficient Power Conversion Corporation.
U.S. Patents 8,350,294; 8,404,508; 8,431,960; 8,436,398; 8,785,974; 8,890,168; 8,969,918; 8,853,749; 8,823,012

Information subject to change without notice.

Revised July, 2016