

# PV2 SERIES ANTI-VANDAL SWITCH

ANTI-VANDAL SWITCHES  
DETECTOR SWITCHES  
DIP SWITCHES  
KEYLOCK SWITCHES  
NAVIGATION SWITCHES  
PUSHBUTTON SWITCHES  
ROCKER SWITCHES  
ROTARY SWITCHES  
SLIDE SWITCHES  
SNAP ACTION SWITCHES  
TACTILE SWITCHES  
TOGGLE SWITCHES  
CAP OPTIONS

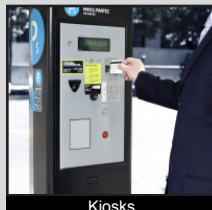

## APPLICATIONS / MARKETS

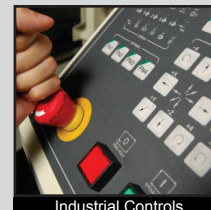
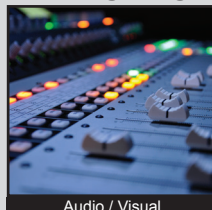

**RoHS**

## SPECIFICATIONS

**Electrical Rating:** 2A, 36VDC  
**Mechanical Life:** 1,000,000 Cycles  
**Electrical Life:** 200,000 Cycles  
**Contact Resistance:** 50mΩ Max.  
**Insulation Resistance:** 1000 MΩ Min.  
**Dielectric Strength:** 2,000VAC  
**Operating/Storage Temperature:** -20°C to 55°C  
**Travel:** 2.50mm  
**Moisture Protection:** IP65  
**Contact Arrangement:** SPST Off-(On)  
**Actuation Force:** 4 N  
**Panel Thickness:** 1-6mm  
**Mounting Nut Torque:** 0.8Nm

## FEATURES & BENEFITS

- 16mm panel cutout
- Solder or screw termination options
- Flat, high or domed actuator options
- IP65 rated

## PART NUMBER CONFIGURATOR

Series	Actuator Options	Terminal Options	Function Options	Rating Options	Body Finish Options	Actuator Finish Options	Contact Material Options	Marking Options
<input type="text" value="PV2"/>	<input type="text" value="F"/> F - Flat <input type="text" value="H"/> H - High <input type="text" value="S"/> S - Domed	<input type="text" value="2"/> 2 - Solder <input type="text" value="6"/> 6 - Screw	<input type="text" value="4"/> 4 - Off - (On)*	<input type="text" value="0"/> 0 - 2A, 36VDC	<input type="text" value="G"/> G - Gold <input type="text" value="N"/> N - Nickel <input type="text" value="S"/> S - Polished Stainless <input type="text" value="B"/> B - Brushed Stainless <input type="text" value="1"/> 1 - Black Anod- ized	<input type="text" value="G"/> G - Gold <input type="text" value="N"/> N - Nickel <input type="text" value="S"/> S - Polished Stainless <input type="text" value="B"/> B - Brushed Stainless <input type="text" value="1"/> 1 - Black Anod- ized	<input type="text" value="NONE"/> NONE - Silver <input type="text" value="G"/> G - Gold	<input type="text" value="NONE"/> NONE - Non- Illuminated <input type="text" value="M01"/> M01 - Power Symbol

NOTES:  
\*(ON) Denotes function is momentary

Specifications subject to change without notice



**E-SWITCH®**

www.e-switch.com

800.867.2717

2

# PV2 SERIES ANTI-VANDAL SWITCH

## SOLDER TERMINATION

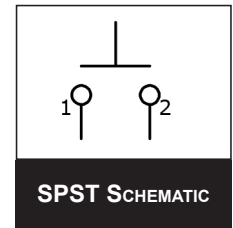
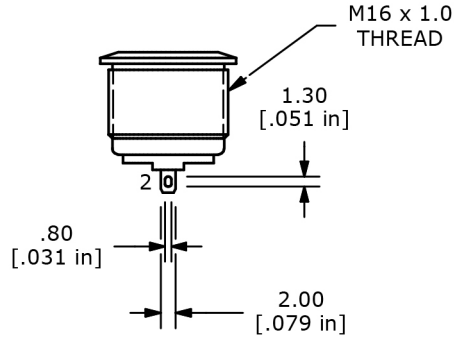
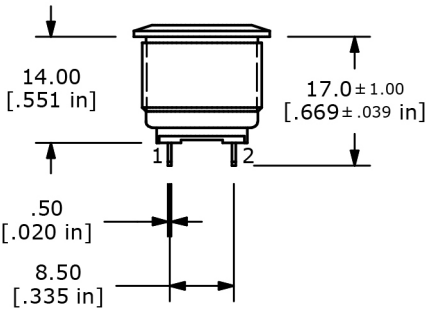
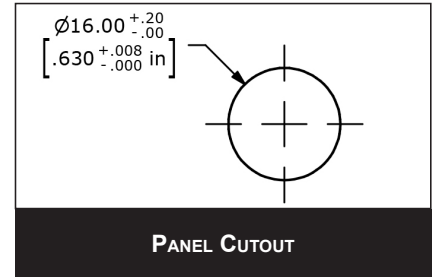
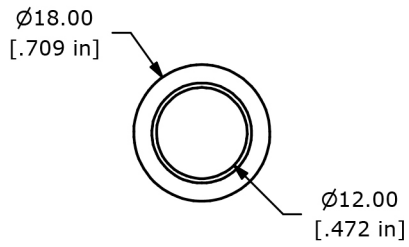

## SCREW TERMINATION

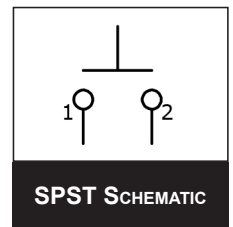
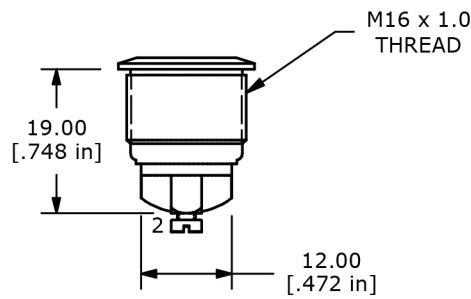
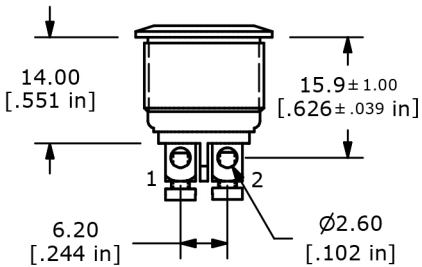
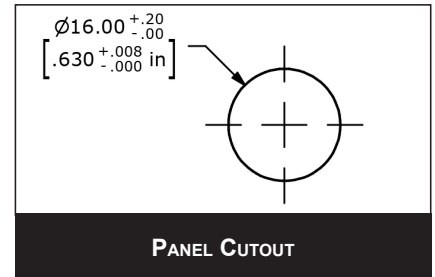
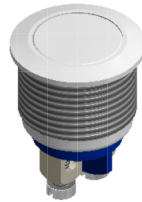
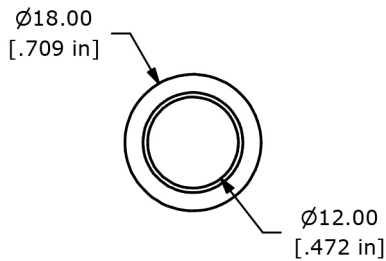

# PV2 SERIES ANTI-VANDAL SWITCH

ANTI-VANDAL SWITCHES  
 DETECTOR SWITCHES  
 DIP SWITCHES  
 KEYLOCK SWITCHES  
 NAVIGATION SWITCHES  
 PUSHBUTTON SWITCHES  
 ROCKER SWITCHES  
 ROTARY SWITCHES  
 SLIDE SWITCHES  
 SNAP ACTION SWITCHES  
 TACTILE SWITCHES  
 TOGGLE SWITCHES  
 CAP OPTIONS

## ACTUATOR OPTIONS

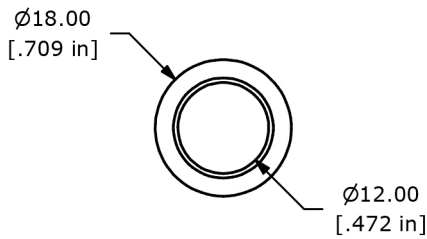

FLAT ACTUATOR

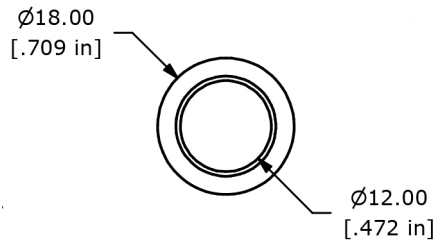

HIGH ACTUATOR

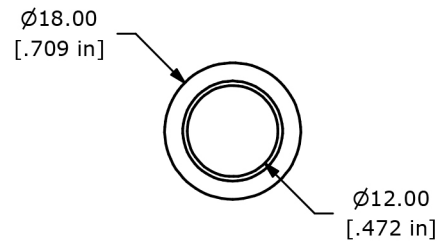

DOMED ACTUATOR

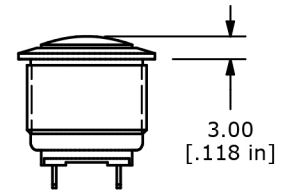
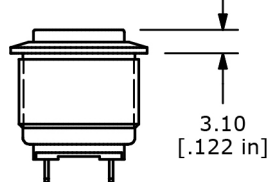
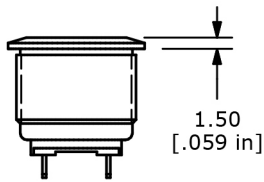

## GRAPHIC OPTIONS

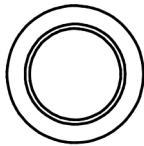

NONE

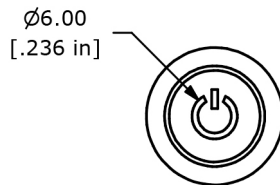

M01 POWER SYMBOL

