

2N7002L

Small Signal MOSFET 60 V, 115 mA, N-Channel SOT-23

Features

- AEC Qualified
- PPAP Capable
- Pb-Free Packages are Available

MAXIMUM RATINGS

Rating	Symbol	Value	Unit
Drain-Source Voltage	V_{DSS}	60	Vdc
Drain-Gate Voltage ($R_{GS} = 1.0 \text{ M}\Omega$)	V_{DGR}	60	Vdc
Drain Current - Continuous $T_C = 25^\circ\text{C}$ (Note 1) - Pulsed (Note 2) $T_C = 100^\circ\text{C}$ (Note 1)	I_D I_{D1} I_{DM}	± 115 ± 75 ± 800	mAdc
Gate-Source Voltage - Continuous - Non-repetitive ($t_p \leq 50 \mu\text{s}$)	V_{GS} V_{GSM}	± 20 ± 40	Vdc Vpk

THERMAL CHARACTERISTICS

Characteristic	Symbol	Max	Unit
Total Device Dissipation FR-5 Board (Note 3) $T_A = 25^\circ\text{C}$ Derate above 25°C	P_D	225 1.8	mW mW/ $^\circ\text{C}$
Thermal Resistance, Junction-to-Ambient	$R_{\theta JA}$	556	$^\circ\text{C}/\text{W}$
Total Device Dissipation Alumina Substrate, (Note 4) $T_A = 25^\circ\text{C}$ Derate above 25°C	P_D	300 2.4	mW mW/ $^\circ\text{C}$
Thermal Resistance, Junction-to-Ambient	$R_{\theta JA}$	417	$^\circ\text{C}/\text{W}$
Junction and Storage Temperature	T_J, T_{stg}	-55 to +150	$^\circ\text{C}$

Stresses exceeding Maximum Ratings may damage the device. Maximum Ratings are stress ratings only. Functional operation above the Recommended Operating Conditions is not implied. Extended exposure to stresses above the Recommended Operating Conditions may affect device reliability.

1. The Power Dissipation of the package may result in a lower continuous drain current.
2. Pulse Test: Pulse Width $\leq 300 \mu\text{s}$, Duty Cycle $\leq 2.0\%$.
3. FR-5 = $1.0 \times 0.75 \times 0.062$ in.
4. Alumina = $0.4 \times 0.3 \times 0.025$ in 99.5% alumina.



ON Semiconductor®

<http://onsemi.com>

$V_{(BR)DSS}$	$R_{DS(on)}$ MAX	I_D MAX
60 V	$7.5 \Omega @ 10 \text{ V}, 500 \text{ mA}$	115 mA

N-Channel

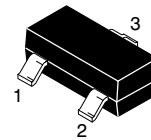
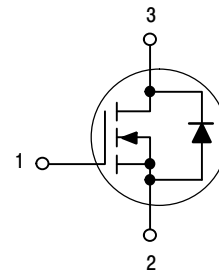

SOT-23
CASE 318
STYLE 21

MARKING DIAGRAM

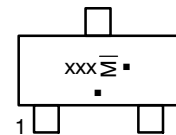

- 702 = Device Code
- M = Date Code*
- = Pb-Free Package

(Note: Microdot may be in either location)
*Date Code orientation and/or position may vary depending upon manufacturing location.

ORDERING INFORMATION

Device	Package	Shipping†
2N7002LT1	SOT-23	3000 Tape & Reel
2N7002LT3		10,000 Tape & Reel
2N7002LT1G	SOT-23 (Pb-free)	3000 Tape & Reel
2N7002LT3G		10,000 Tape & Reel

†For information on tape and reel specifications, including part orientation and tape sizes, please refer to our Tape and Reel Packaging Specifications Brochure, BRD8011/D.

2N7002L

ELECTRICAL CHARACTERISTICS (T_A = 25°C unless otherwise noted)

Characteristic	Symbol	Min	Typ	Max	Unit
----------------	--------	-----	-----	-----	------

OFF CHARACTERISTICS

Drain-Source Breakdown Voltage (V _{GS} = 0, I _D = 10 μAdc)	V _{(BR)DSS}	60	-	-	Vdc
Zero Gate Voltage Drain Current (V _{GS} = 0, V _{DS} = 60 Vdc)	I _{DSS}	T _J = 25°C	-	-	1.0
		T _J = 125°C	-	-	500
Gate-Body Leakage Current, Forward (V _{GS} = 20 Vdc)	I _{GSSF}	-	-	100	nAdc
Gate-Body Leakage Current, Reverse (V _{GS} = -20 Vdc)	I _{GSSR}	-	-	-100	nAdc

ON CHARACTERISTICS (Note 5)

Gate Threshold Voltage (V _{DS} = V _{GS} , I _D = 250 μAdc)	V _{GS(th)}	1.0	-	2.5	Vdc
On-State Drain Current (V _{DS} ≥ 2.0 V _{DS(on)} , V _{GS} = 10 Vdc)	I _{D(on)}	500	-	-	mA
Static Drain-Source On-State Voltage (V _{GS} = 10 Vdc, I _D = 500 mAdc) (V _{GS} = 5.0 Vdc, I _D = 50 mAdc)	V _{DS(on)}	-	-	3.75	Vdc
		-	-	0.375	
Static Drain-Source On-State Resistance (V _{GS} = 10 V, I _D = 500 mAdc) (V _{GS} = 5.0 Vdc, I _D = 50 mAdc)	r _{DS(on)}	T _C = 25°C	-	-	7.5
		T _C = 125°C	-	-	13.5
		T _C = 25°C	-	-	7.5
		T _C = 125°C	-	-	13.5
Forward Transconductance (V _{DS} ≥ 2.0 V _{DS(on)} , I _D = 200 mAdc)	g _{FS}	80	-	-	mmhos

DYNAMIC CHARACTERISTICS

Input Capacitance (V _{DS} = 25 Vdc, V _{GS} = 0, f = 1.0 MHz)	C _{iss}	-	-	50	pF
Output Capacitance (V _{DS} = 25 Vdc, V _{GS} = 0, f = 1.0 MHz)	C _{oss}	-	-	25	pF
Reverse Transfer Capacitance (V _{DS} = 25 Vdc, V _{GS} = 0, f = 1.0 MHz)	C _{rss}	-	-	5.0	pF

SWITCHING CHARACTERISTICS (Note 5)

Turn-On Delay Time	(V _{DD} = 25 Vdc, I _D ≅ 500 mAdc, R _G = 25 Ω, R _L = 50 Ω, V _{gen} = 10 V)	t _{d(on)}	-	-	20	ns
Turn-Off Delay Time		t _{d(off)}	-	-	40	ns

BODY-DRAIN DIODE RATINGS

Diode Forward On-Voltage (I _S = 11.5 mAdc, V _{GS} = 0 V)	V _{SD}	-	-	-1.5	Vdc
Source Current Continuous (Body Diode)	I _S	-	-	-115	mAdc
Source Current Pulsed	I _{SM}	-	-	-800	mAdc

5. Pulse Test: Pulse Width ≤ 300 μs, Duty Cycle ≤ 2.0%.

TYPICAL ELECTRICAL CHARACTERISTICS

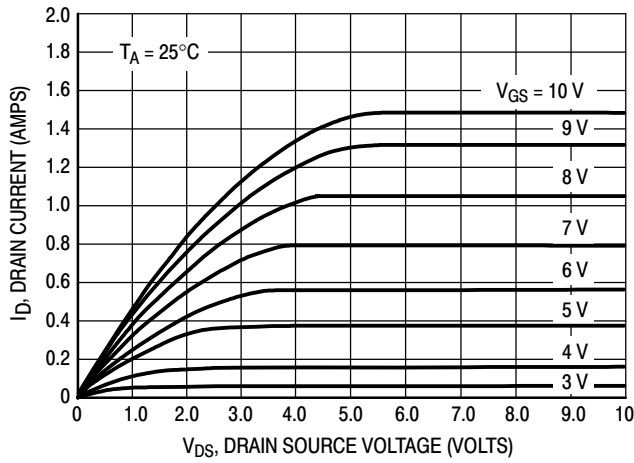

Figure 1. Ohmic Region

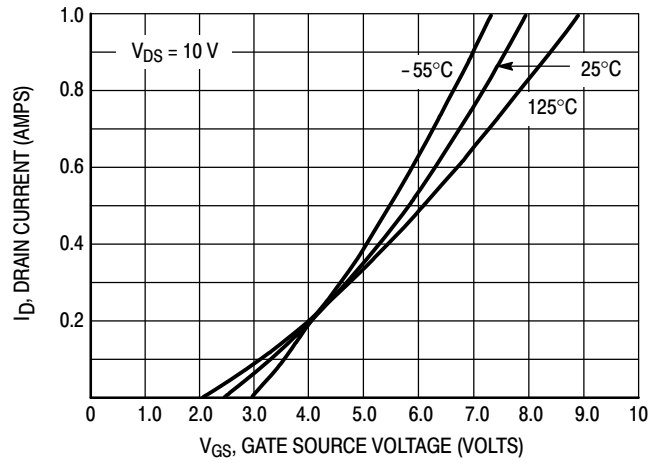

Figure 2. Transfer Characteristics

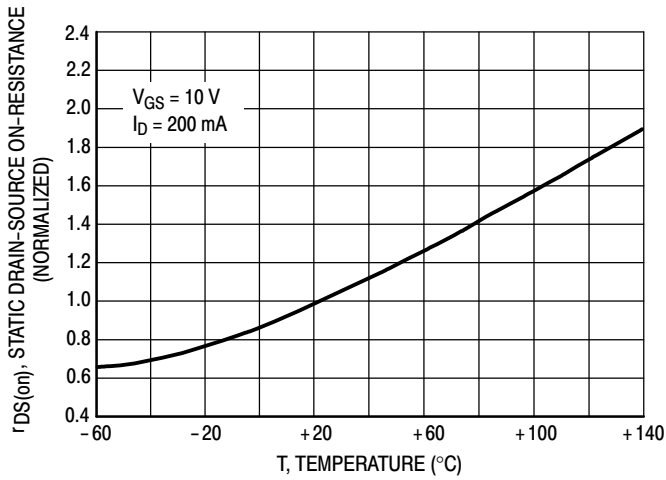

Figure 3. Temperature versus Static Drain-Source On-Resistance

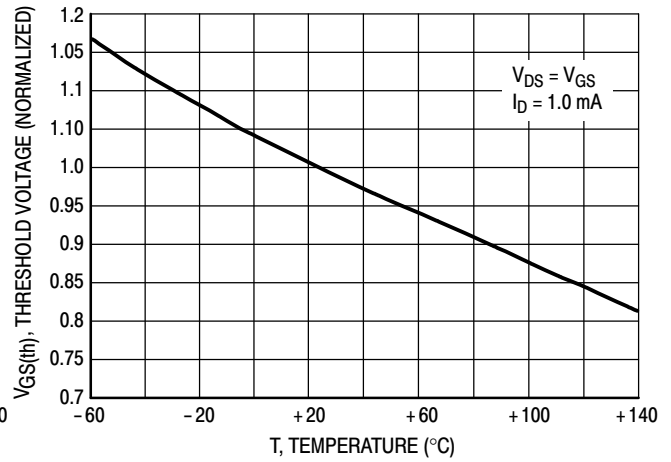
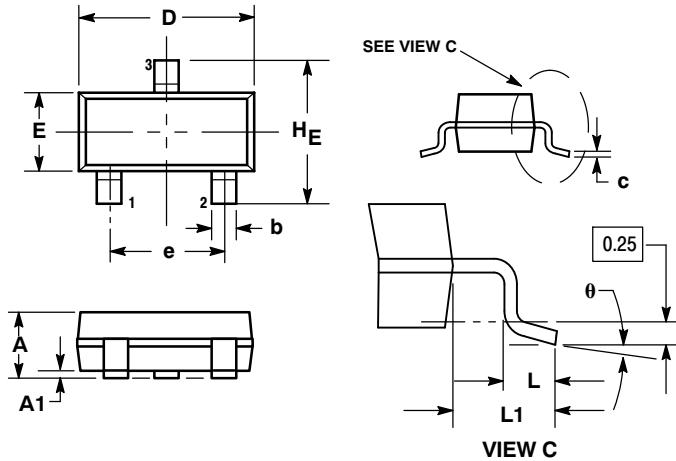

Figure 4. Temperature versus Gate Threshold Voltage

2N7002L

PACKAGE DIMENSIONS

SOT-23 (TO-236)
CASE 318-08
ISSUE AN



NOTES:

1. DIMENSIONING AND TOLERANCING PER ANSI Y14.5M, 1982.
2. CONTROLLING DIMENSION: INCH.
3. MAXIMUM LEAD THICKNESS INCLUDES LEAD FINISH THICKNESS. MINIMUM LEAD THICKNESS IS THE MINIMUM THICKNESS OF BASE MATERIAL.
4. 318-01 THRU -07 AND -09 OBSOLETE, NEW STANDARD 318-08.

DIM	MILLIMETERS			INCHES		
	MIN	NOM	MAX	MIN	NOM	MAX
A	0.89	1.00	1.11	0.035	0.040	0.044
A1	0.01	0.06	0.10	0.001	0.002	0.004
b	0.37	0.44	0.50	0.015	0.018	0.020
c	0.09	0.13	0.18	0.003	0.005	0.007
D	2.80	2.90	3.04	0.110	0.114	0.120
E	1.20	1.30	1.40	0.047	0.051	0.055
e	1.78	1.90	2.04	0.070	0.075	0.081
L	0.10	0.20	0.30	0.004	0.008	0.012
L1	0.35	0.54	0.69	0.014	0.021	0.029
HE	2.10	2.40	2.64	0.083	0.094	0.104

STYLE 21:

1. GATE
2. SOURCE
3. DRAIN

SOLDERING FOOTPRINT

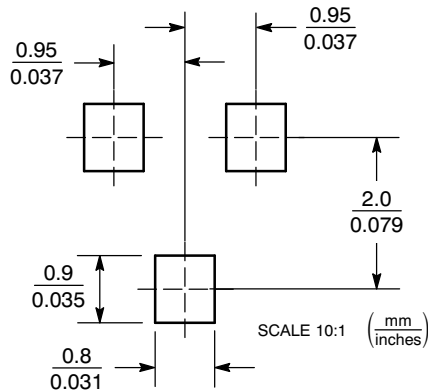

*For additional information on our Pb-Free strategy and soldering details, please download the ON Semiconductor Soldering and Mounting Techniques Reference Manual, SOLDERRM/D.

ON Semiconductor and are registered trademarks of Semiconductor Components Industries, LLC (SCILLC). SCILLC reserves the right to make changes without further notice to any products herein. SCILLC makes no warranty, representation or guarantee regarding the suitability of its products for any particular purpose, nor does SCILLC assume any liability arising out of the application or use of any product or circuit, and specifically disclaims any and all liability, including without limitation special, consequential or incidental damages. "Typical" parameters which may be provided in SCILLC data sheets and/or specifications can and do vary in different applications and actual performance may vary over time. All operating parameters, including "Typicals" must be validated for each customer application by customer's technical experts. SCILLC does not convey any license under its patent rights nor the rights of others. SCILLC products are not designed, intended, or authorized for use as components in systems intended for surgical implant into the body, or other applications intended to support or sustain life, or for any other application in which the failure of the SCILLC product could create a situation where personal injury or death may occur. Should Buyer purchase or use SCILLC products for any such unintended or unauthorized application, Buyer shall indemnify and hold SCILLC and its officers, employees, subsidiaries, affiliates, and distributors harmless against all claims, costs, damages, and expenses, and reasonable attorney fees arising out of, directly or indirectly, any claim of personal injury or death associated with such unintended or unauthorized use, even if such claim alleges that SCILLC was negligent regarding the design or manufacture of the part. SCILLC is an Equal Opportunity/Affirmative Action Employer. This literature is subject to all applicable copyright laws and is not for resale in any manner.

PUBLICATION ORDERING INFORMATION

LITERATURE FULFILLMENT:
Literature Distribution Center for ON Semiconductor
P.O. Box 5163, Denver, Colorado 80217 USA
Phone: 303-675-2175 or 800-344-3860 Toll Free USA/Canada
Fax: 303-675-2176 or 800-344-3867 Toll Free USA/Canada
Email: orderlit@onsemi.com

N. American Technical Support: 800-282-9855 Toll Free
USA/Canada

Japan: ON Semiconductor, Japan Customer Focus Center
2-9-1 Kamimeguro, Meguro-ku, Tokyo, Japan 153-0051
Phone: 81-3-5773-3850

ON Semiconductor Website: <http://onsemi.com>

Order Literature: <http://www.onsemi.com/litorder>

For additional information, please contact your local Sales Representative.