

## TRENCHSTOP™ Series

## Low Loss DuoPack: IGBT in TRENCHSTOP™ and Fieldstop technology with soft, fast recovery anti-parallel diode

### Features:

- Automotive AEC Q101 qualified
- Designed for DC/AC converters for Automotive Application
- Very low  $V_{CE(sat)}$  1.5V (typ.)
- Maximum Junction Temperature 150°C
- Dynamically stress tested
- Short circuit withstand time 5 $\mu$ s
- Positive temperature coefficient in  $V_{CE(sat)}$
- Low EMI
- Low Gate Charge
- Green Package
- TRENCHSTOP™ and Fieldstop technology for 600V applications offers:
  - very tight parameter distribution
  - high ruggedness, temperature stable behavior
  - very high switching speed

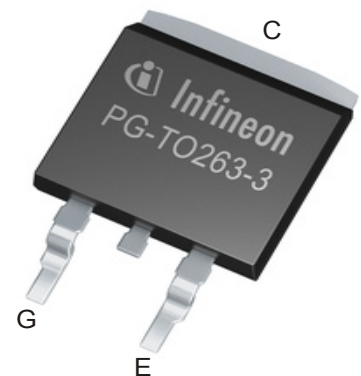
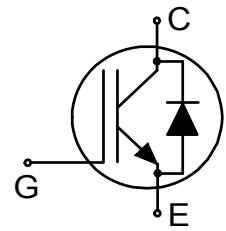

### Applications:

- Main inverter
- Climate compressor
- PTC heater
- Motor drives



### Key Performance and Package Parameters

Type	$V_{CE}$	$I_C$	$V_{CEsat}, T_{vj}=25^\circ\text{C}$	$T_{vjmax}$	Marking	Package
AIKB20N60CT	600V	20A	1.5V	150°C	AK20DCT	PG-TO263-3



**Table of Contents**

Description ..... 1

Table of Contents ..... 2

Maximum Ratings ..... 3

Thermal Resistance ..... 3

Electrical Characteristics ..... 4

Electrical Characteristics Diagrams ..... 6

Package Drawing .....13

Testing Conditions .....14

Revision History .....15

Disclaimer .....16

## TRENCHSTOP™ Series

## Maximum Ratings

Parameter	Symbol	Value	Unit
Collector-emitter voltage, $T_{vj} \geq 25^{\circ}\text{C}$	$V_{CE}$	600	V
DC collector current, limited by $T_{vjmax}$ $T_C = 25^{\circ}\text{C}$ $T_C = 100^{\circ}\text{C}$	$I_C$	40.0 20.0	A
Pulsed collector current, $t_p$ limited by $T_{vjmax}$	$I_{Cpuls}$	60.0	A
Turn off safe operating area $V_{CE} \leq 600\text{V}$ , $T_{vj} \leq 150^{\circ}\text{C}^{1)}$	-	60.0	A
Diode forward current, limited by $T_{vjmax}$ $T_C = 25^{\circ}\text{C}$ $T_C = 100^{\circ}\text{C}$	$I_F$	40.0 20.0	A
Diode pulsed current, $t_p$ limited by $T_{vjmax}$	$I_{Fpuls}$	60.0	A
Gate-emitter voltage	$V_{GE}$	$\pm 20$	V
Short circuit withstand time $V_{GE} = 15.0\text{V}$ , $V_{CC} \leq 400\text{V}$ Allowed number of short circuits < 1000 Time between short circuits: $\geq 1.0\text{s}$ $T_{vj} = 150^{\circ}\text{C}$	$t_{SC}$	5	$\mu\text{s}$
Power dissipation $T_C = 25^{\circ}\text{C}$	$P_{tot}$	156.0	W
Operating junction temperature	$T_{vj}$	-40...+150	$^{\circ}\text{C}$
Storage temperature	$T_{stg}$	-40...+150	$^{\circ}\text{C}$
Soldering temperature, reflow soldering (MSL1 according to JEDEC J-STA-020)		260	$^{\circ}\text{C}$

## Thermal Resistance

Parameter	Symbol	Conditions	Value			Unit
			min.	typ.	max.	
<b>R<sub>th</sub> Characteristics</b>						
IGBT thermal resistance, junction - case	$R_{th(j-c)}$		-	-	0.90	K/W
Diode thermal resistance, junction - case	$R_{th(j-c)}$		-	-	1.50	K/W
Thermal resistance, min. footprint junction - ambient	$R_{th(j-a)}$		-	-	65	K/W
Thermal resistance, 6cm <sup>2</sup> Cu on PCB junction - ambient	$R_{th(j-a)}$		-	-	40	K/W

<sup>1)</sup>  $t_p \leq 1\mu\text{s}$

## TRENCHSTOP™ Series

Electrical Characteristic, at  $T_{vj} = 25^{\circ}\text{C}$ , unless otherwise specified

Parameter	Symbol	Conditions	Value			Unit
			min.	typ.	max.	
<b>Static Characteristic</b>						
Collector-emitter breakdown voltage	$V_{(BR)CES}$	$V_{GE} = 0\text{V}, I_C = 0.20\text{mA}$	600	-	-	V
Collector-emitter saturation voltage	$V_{CEsat}$	$V_{GE} = 15.0\text{V}, I_C = 20.0\text{A}$ $T_{vj} = 25^{\circ}\text{C}$ $T_{vj} = 150^{\circ}\text{C}$	- -	1.50 1.85	2.05 -	V
Diode forward voltage	$V_F$	$V_{GE} = 0\text{V}, I_F = 20.0\text{A}$ $T_{vj} = 25^{\circ}\text{C}$ $T_{vj} = 150^{\circ}\text{C}$	- -	1.65 1.65	2.05 -	V
Gate-emitter threshold voltage	$V_{GE(th)}$	$I_C = 0.29\text{mA}, V_{CE} = V_{GE}$	4.1	4.9	5.7	V
Zero gate voltage collector current	$I_{CES}$	$V_{CE} = 600\text{V}, V_{GE} = 0\text{V}$ $T_{vj} = 25^{\circ}\text{C}$ $T_{vj} = 150^{\circ}\text{C}$	- -	- 550	40 -	$\mu\text{A}$
Gate-emitter leakage current	$I_{GES}$	$V_{CE} = 0\text{V}, V_{GE} = 20\text{V}$	-	-	100	nA
Transconductance	$g_{fs}$	$V_{CE} = 20\text{V}, I_C = 20.0\text{A}$	-	11.0	-	S
Integrated gate resistor	$r_G$			none		$\Omega$

Electrical Characteristic, at  $T_{vj} = 25^{\circ}\text{C}$ , unless otherwise specified

Parameter	Symbol	Conditions	Value			Unit
			min.	typ.	max.	
<b>Dynamic Characteristic</b>						
Input capacitance	$C_{ies}$	$V_{CE} = 25\text{V}, V_{GE} = 0\text{V}, f = 1\text{MHz}$	-	1100	-	pF
Output capacitance	$C_{oes}$		-	71	-	
Reverse transfer capacitance	$C_{res}$		-	32	-	
Gate charge	$Q_G$	$V_{CC} = 480\text{V}, I_C = 20.0\text{A},$ $V_{GE} = 15\text{V}$	-	120.0	-	nC
Internal emitter inductance measured 5mm (0.197 in.) from case	$L_E$		-	7.0	-	nH
Short circuit collector current Max. 1000 short circuits Time between short circuits: $\geq 1.0\text{s}$	$I_{C(SC)}$	$V_{GE} = 15.0\text{V}, V_{CC} \leq 400\text{V},$ $t_{SC} \leq 5\mu\text{s}$ $T_{vj} = 150^{\circ}\text{C}$	-	183	-	A

## Switching Characteristic, Inductive Load

Parameter	Symbol	Conditions	Value			Unit
			min.	typ.	max.	
<b>IGBT Characteristic, at <math>T_{vj} = 25^{\circ}\text{C}</math></b>						
Turn-on delay time	$t_{d(on)}$	$T_{vj} = 25^{\circ}\text{C},$ $V_{CC} = 600\text{V}, I_C = 20.0\text{A},$ $V_{GE} = 0.0/15.0\text{V},$ $R_{G(on)} = 12.0\Omega, R_{G(off)} = 12.0\Omega,$ $L_{\sigma} = 131\text{nH}, C_{\sigma} = 31\text{pF}$ $L_{\sigma}, C_{\sigma}$ from Fig. E Energy losses include "tail" and diode reverse recovery.	-	18	-	ns
Rise time	$t_r$		-	14	-	ns
Turn-off delay time	$t_{d(off)}$		-	199	-	ns
Fall time	$t_f$		-	42	-	ns
Turn-on energy	$E_{on}$		-	0.31	-	mJ
Turn-off energy	$E_{off}$		-	0.46	-	mJ
Total switching energy	$E_{ts}$		-	0.77	-	mJ

## TRENCHSTOP™ Series

Diode Characteristic, at  $T_{vj} = 25^{\circ}\text{C}$ 

Diode reverse recovery time	$t_{rr}$	$T_{vj} = 25^{\circ}\text{C}$ , $V_R = 600\text{V}$ , $I_F = 20.0\text{A}$ , $di_F/dt = 880\text{A}/\mu\text{s}$	-	41	-	ns
Diode reverse recovery charge	$Q_{rr}$		-	0.31	-	$\mu\text{C}$
Diode peak reverse recovery current	$I_{rrm}$		-	13.3	-	A
Diode peak rate of fall of reverse recovery current during $t_b$	$di_{rr}/dt$		-	711	-	$\text{A}/\mu\text{s}$

## Switching Characteristic, Inductive Load

Parameter	Symbol	Conditions	Value			Unit
			min.	typ.	max.	

IGBT Characteristic, at  $T_{vj} = 150^{\circ}\text{C}$ 

Turn-on delay time	$t_{d(on)}$	$T_{vj} = 150^{\circ}\text{C}$ , $V_{CC} = 600\text{V}$ , $I_C = 20.0\text{A}$ , $V_{GE} = 0.0/15.0\text{V}$ , $R_{G(on)} = 12.0\Omega$ , $R_{G(off)} = 12.0\Omega$ , $L\sigma = 131\text{nH}$ , $C\sigma = 31\text{pF}$ $L\sigma$ , $C\sigma$ from Fig. E Energy losses include "tail" and diode reverse recovery.	-	18	-	ns
Rise time	$t_r$		-	17	-	ns
Turn-off delay time	$t_{d(off)}$		-	217	-	ns
Fall time	$t_f$		-	70	-	ns
Turn-on energy	$E_{on}$		-	0.47	-	mJ
Turn-off energy	$E_{off}$		-	0.60	-	mJ
Total switching energy	$E_{ts}$		-	1.07	-	mJ

Diode Characteristic, at  $T_{vj} = 150^{\circ}\text{C}$ 

Diode reverse recovery time	$t_{rr}$	$T_{vj} = 150^{\circ}\text{C}$ , $V_R = 600\text{V}$ , $I_F = 20.0\text{A}$ , $di_F/dt = 800\text{A}/\mu\text{s}$	-	201	-	ns
Diode reverse recovery charge	$Q_{rr}$		-	1.28	-	$\mu\text{C}$
Diode peak reverse recovery current	$I_{rrm}$		-	16.6	-	A
Diode peak rate of fall of reverse recovery current during $t_b$	$di_{rr}/dt$		-	481	-	$\text{A}/\mu\text{s}$

## TRENCHSTOP™ Series

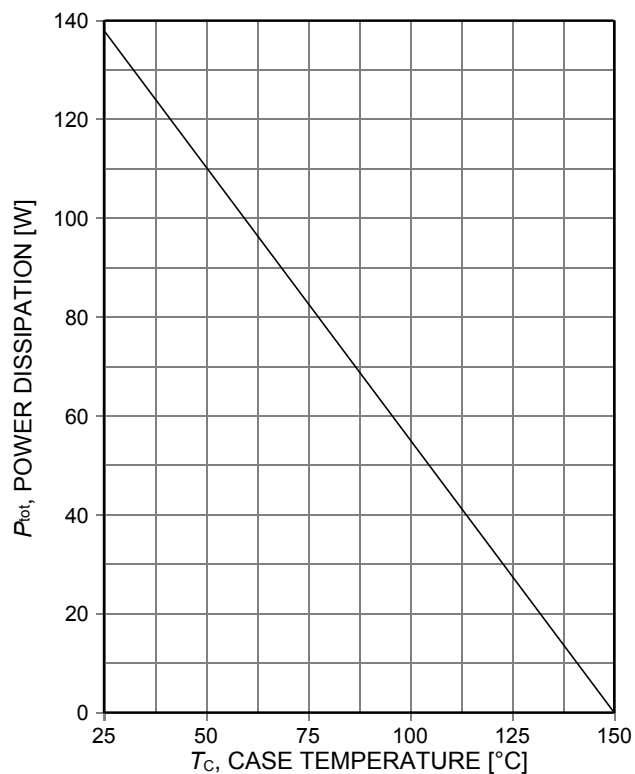

Figure 1. Power dissipation as a function of case temperature ( $T_j \leq 150^\circ\text{C}$ )

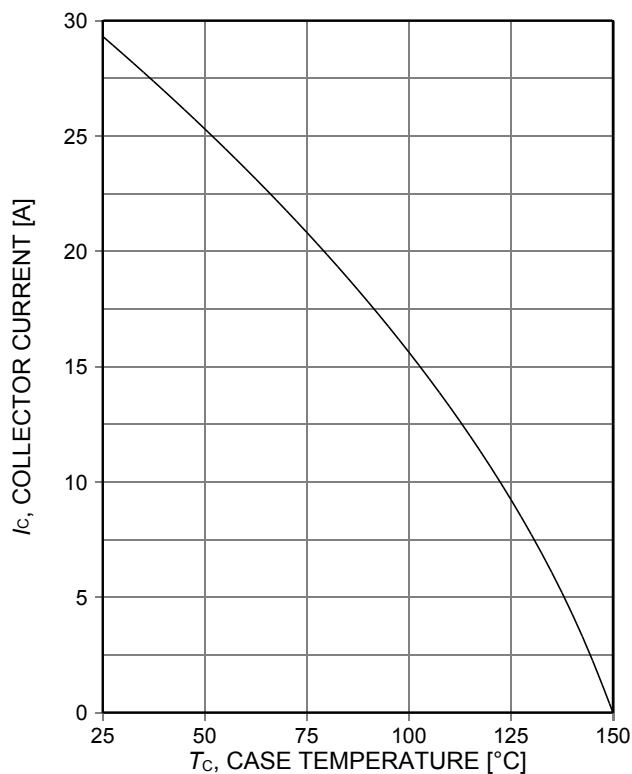

Figure 2. Collector current as a function of case temperature ( $V_{GE} \geq 15\text{V}$ ,  $T_j \leq 150^\circ\text{C}$ )

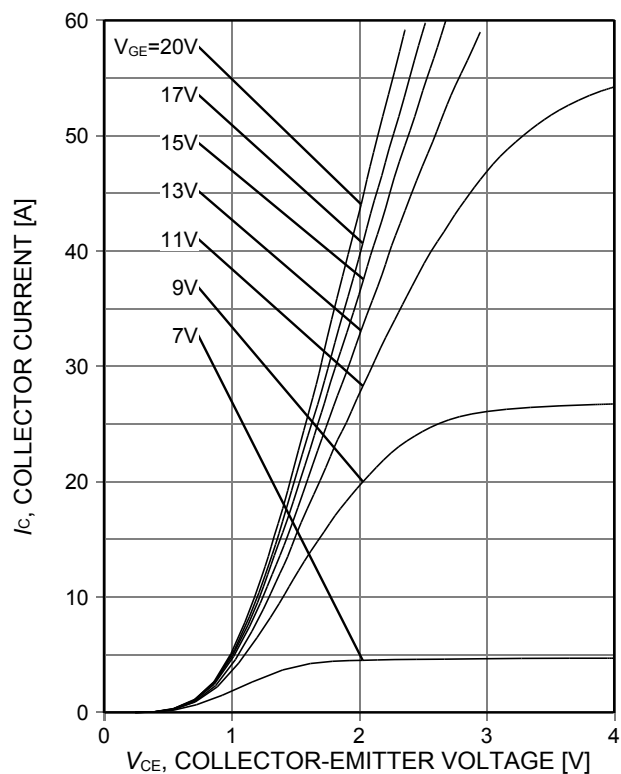

Figure 3. Typical output characteristic ( $T_j = 25^\circ\text{C}$ )

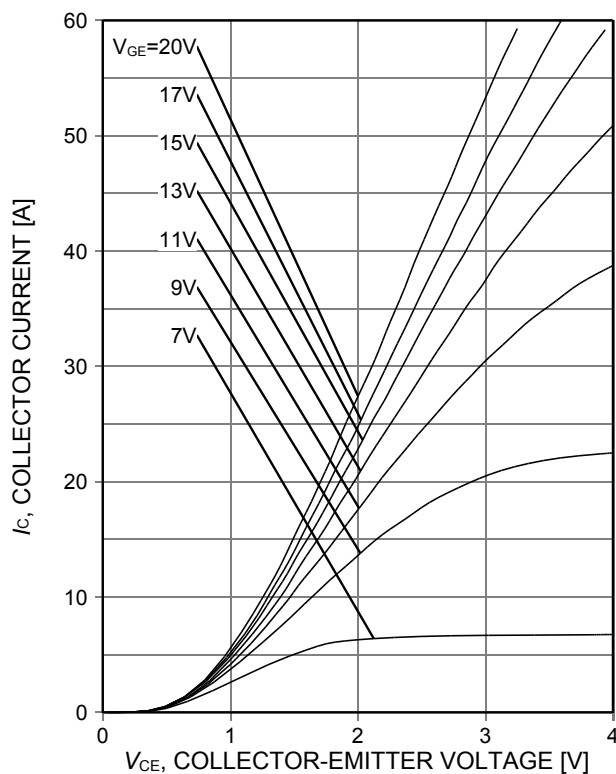

Figure 4. Typical output characteristic ( $T_j = 150^\circ\text{C}$ )

TRENCHSTOP™ Series

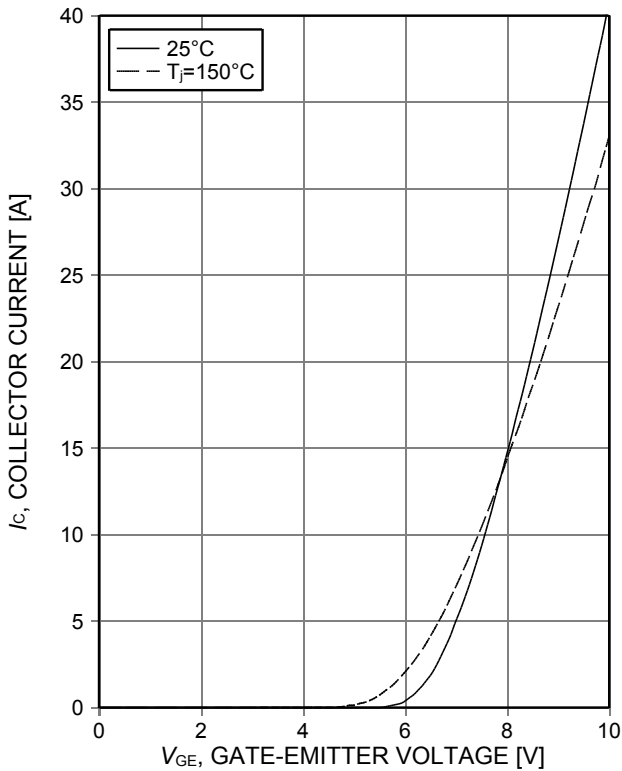

Figure 5. **Typical transfer characteristic**  
( $V_{CE}=10V$ )

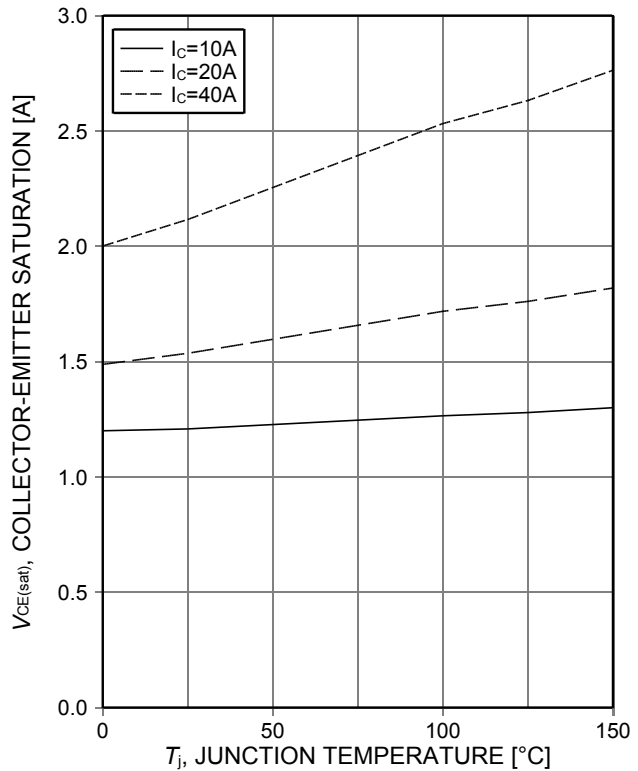

Figure 6. **Typical collector-emitter saturation voltage as a function of junction temperature**  
( $V_{GE}=15V$ )

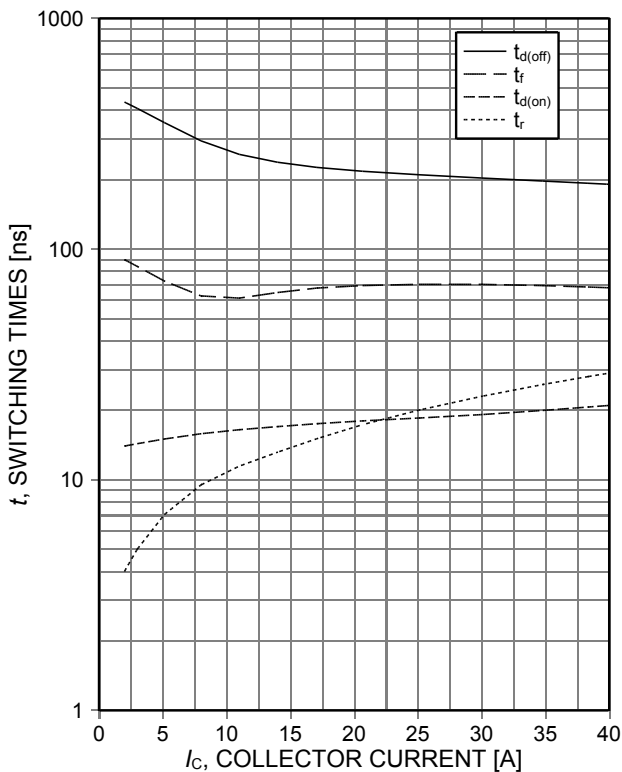

Figure 7. **Typical switching times as a function of collector current**  
(inductive load,  $T_j=150^\circ C$ ,  $V_{CE}=400V$ ,  $V_{GE}=15/0V$ ,  $R_G=12\Omega$ , Dynamic test circuit in Figure E)

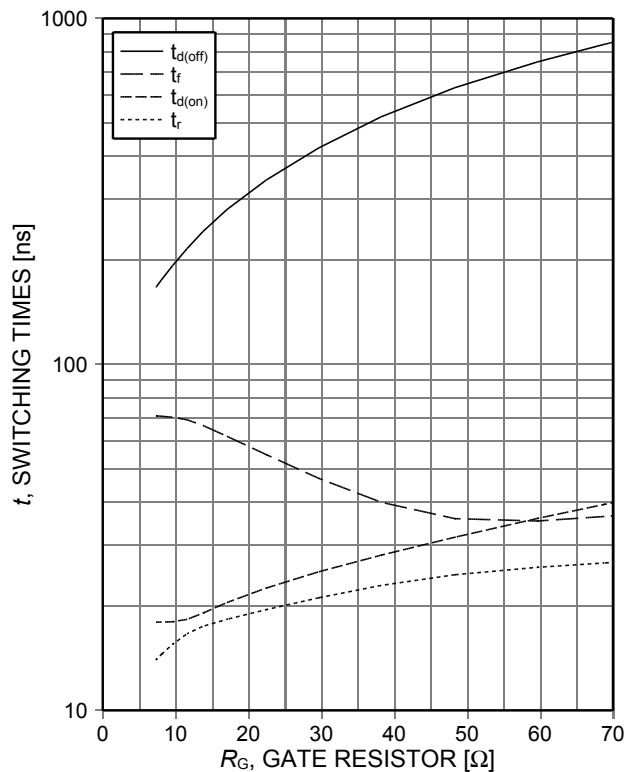

Figure 8. **Typical switching times as a function of gate resistor**  
(inductive load,  $T_j=150^\circ C$ ,  $V_{CE}=400V$ ,  $V_{GE}=15/0V$ ,  $I_C=20A$ , Dynamic test circuit in Figure E)

TRENCHSTOP™ Series

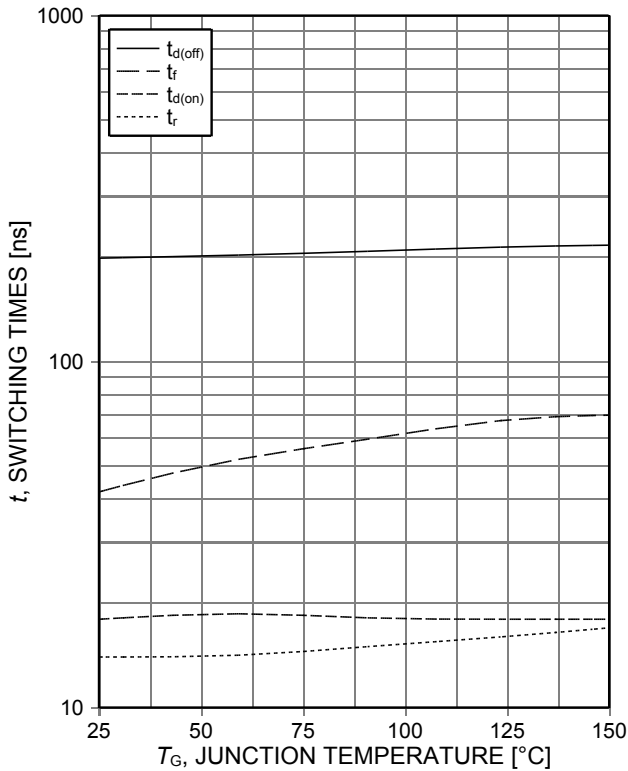

Figure 9. **Typical switching times as a function of junction temperature**  
 (inductive load,  $V_{CE}=400V$ ,  $V_{GE}=15/0V$ ,  $I_C=20A$ ,  $R_G=12\Omega$ , Dynamic test circuit in Figure E)

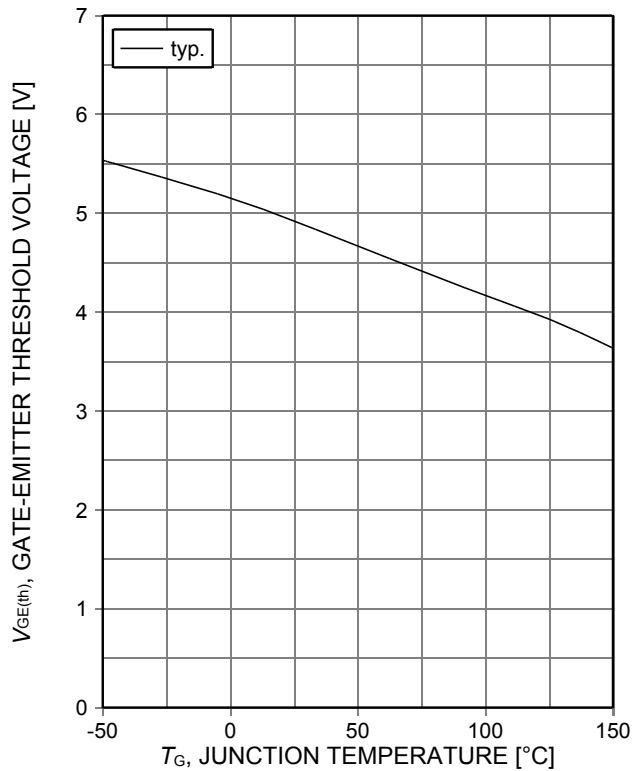

Figure 10. **Gate-emitter threshold voltage as a function of junction temperature**  
 ( $I_C=0.29mA$ )

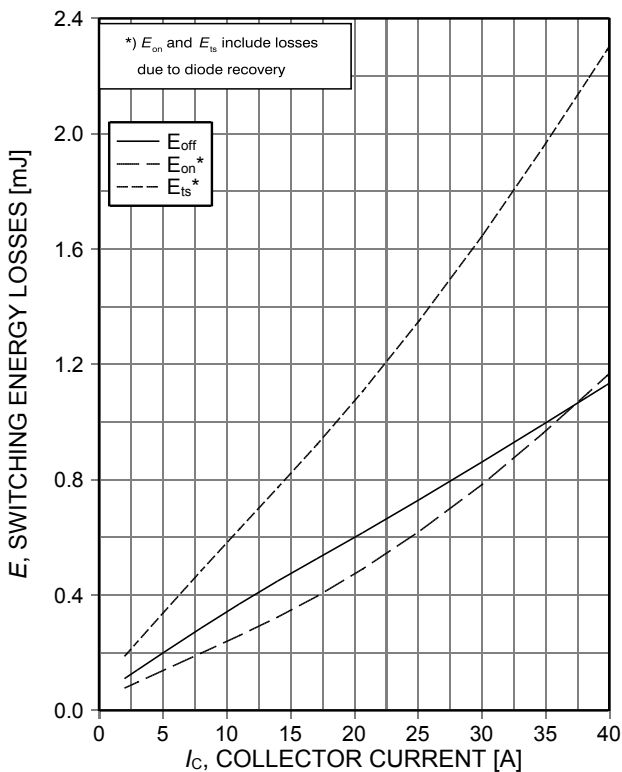

Figure 11. **Typical switching energy losses as a function of collector current**  
 (inductive load,  $T_j=150^\circ C$ ,  $V_{CE}=400V$ ,  $V_{GE}=15/0V$ ,  $R_G=12\Omega$ , Dynamic test circuit in Figure E)

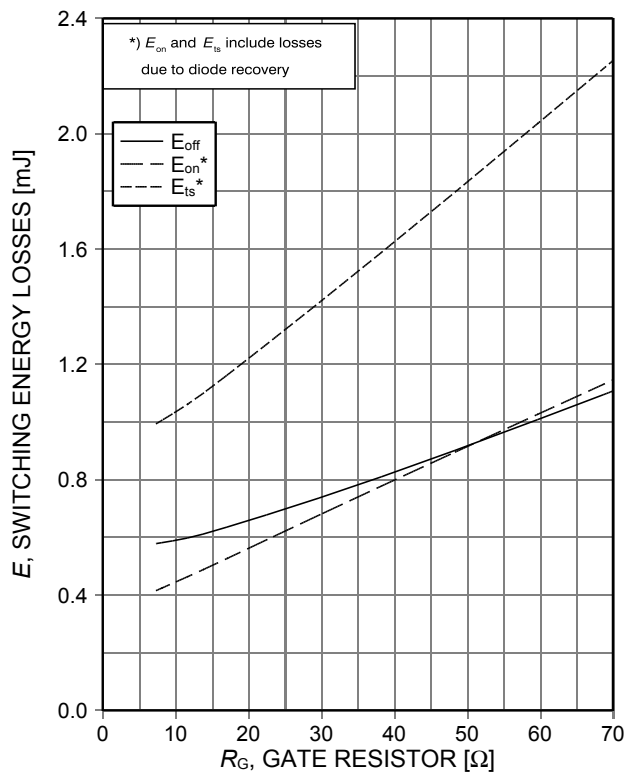

Figure 12. **Typical switching energy losses as a function of gate resistor**  
 (inductive load,  $T_j=150^\circ C$ ,  $V_{CE}=400V$ ,  $V_{GE}=15/0V$ ,  $I_C=20A$ , Dynamic test circuit in Figure E)



TRENCHSTOP™ Series

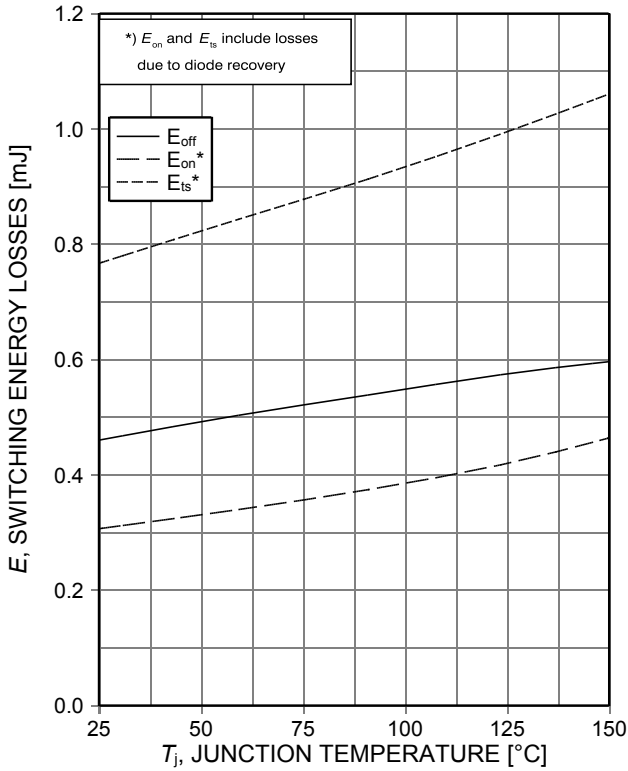

Figure 13. **Typical switching energy losses as a function of junction temperature** (inductive load,  $V_{CE}=400V$ ,  $V_{GE}=15/0V$ ,  $I_C=20A$ ,  $R_G=12\Omega$ , Dynamic test circuit in Figure E)

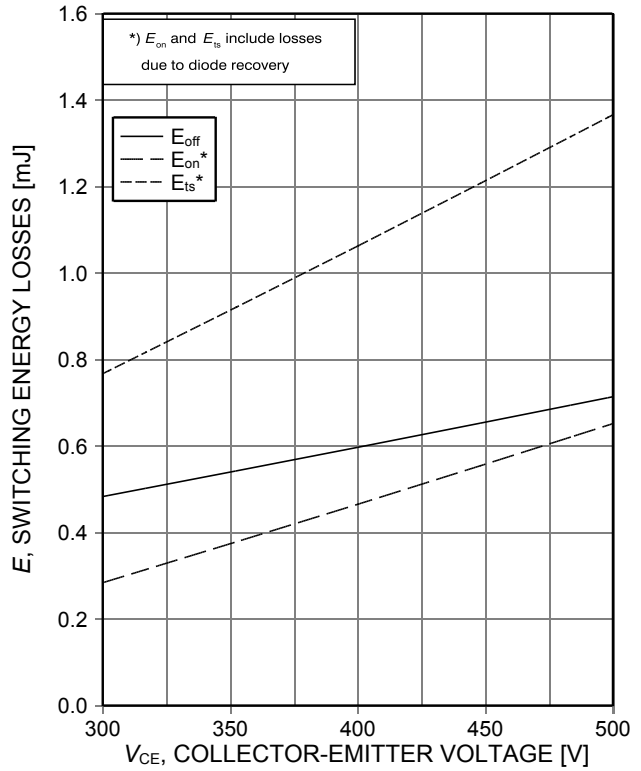

Figure 14. **Typical switching energy losses as a function of collector emitter voltage** (inductive load,  $T_j=150^\circ C$ ,  $V_{GE}=15/0V$ ,  $I_C=20A$ ,  $R_G=12\Omega$ , Dynamic test circuit in Figure E)

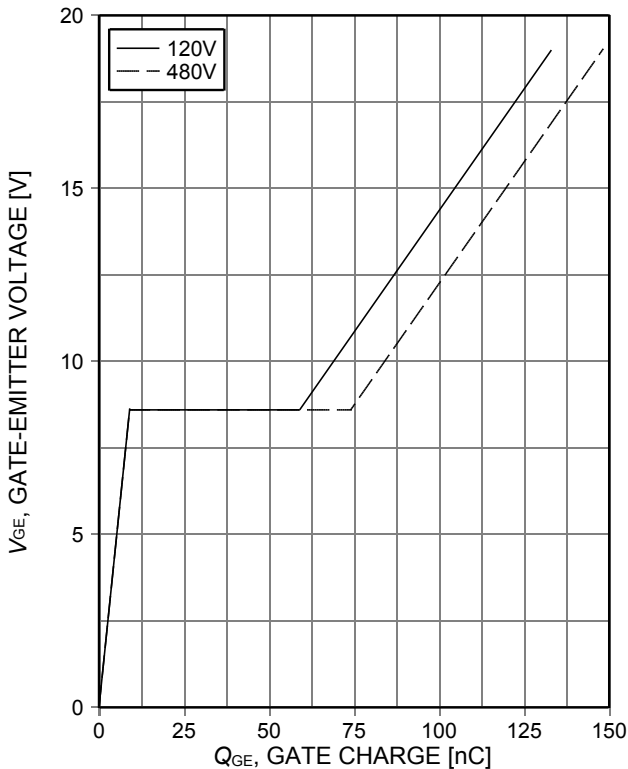

Figure 15. **Typical gate charge** ( $I_C=20A$ )

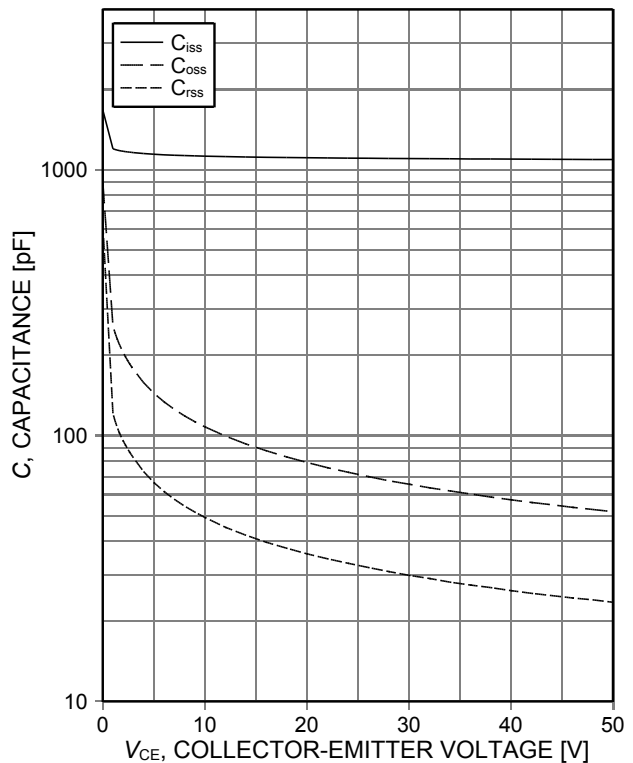

Figure 16. **Typical capacitance as a function of collector-emitter voltage** ( $V_{GE}=0V$ ,  $f=1MHz$ )

TRENCHSTOP™ Series

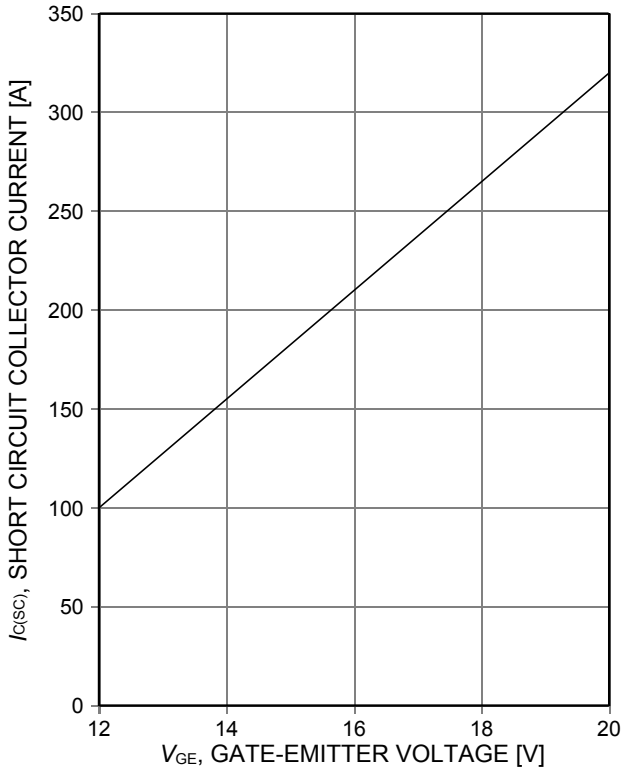

Figure 17. Typical short circuit collector current as a function of gate-emitter voltage (V<sub>CE</sub>≤400V, T<sub>J</sub>≤150°C)

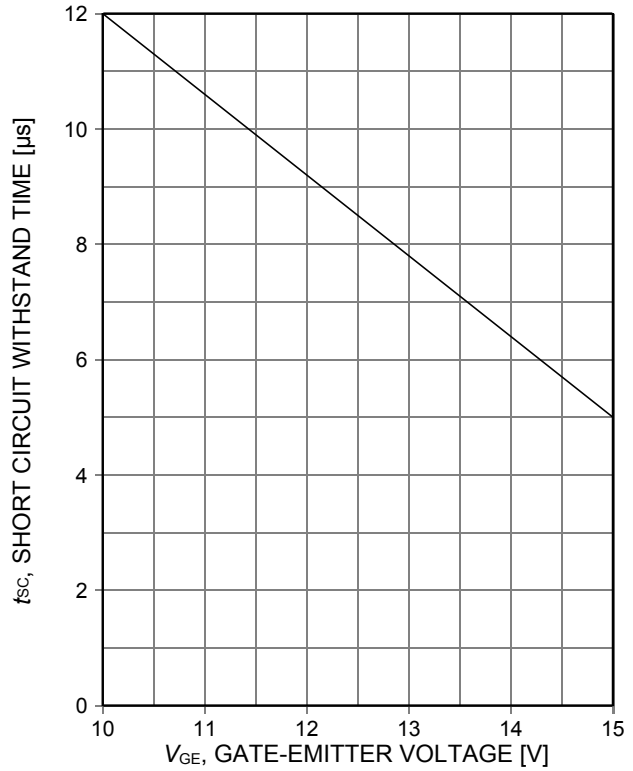

Figure 18. Short circuit withstand time as a function of gate-emitter voltage (V<sub>CE</sub>=400V, start at T<sub>J</sub>=25°C, T<sub>Jmax</sub>≤150°C)

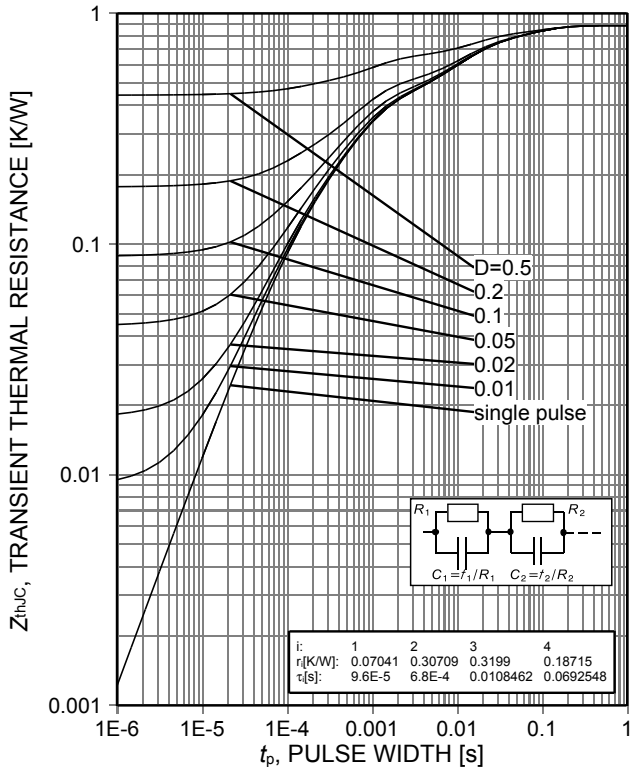

Figure 19. IGBT transient thermal resistance as a function of pulse width for different duty cycles D (D=t<sub>p</sub>/T)

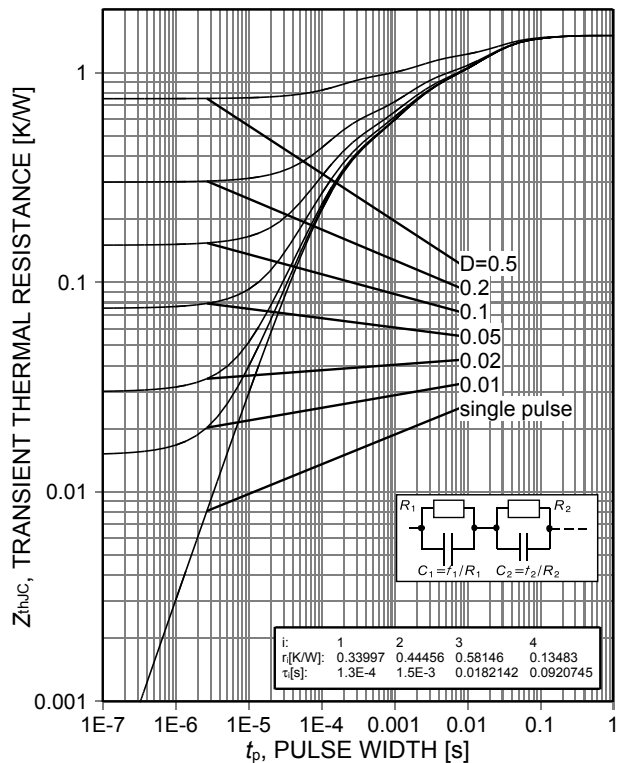

Figure 20. Diode transient thermal impedance as a function of pulse width for different duty cycles D (D=t<sub>p</sub>/T)

TRENCHSTOP™ Series

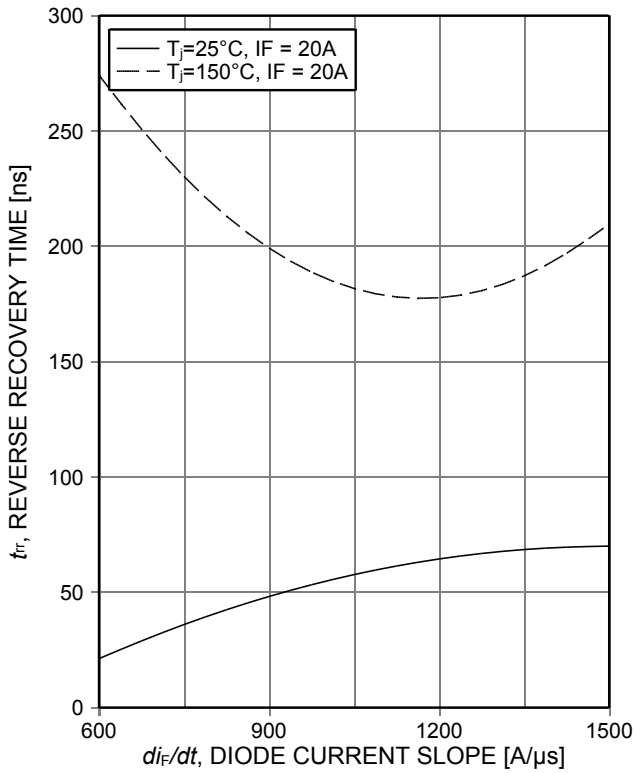

Figure 21. **Typical reverse recovery time as a function of diode current slope**  
( $V_R=400V$ , Dynamic test circuit in Figure E)

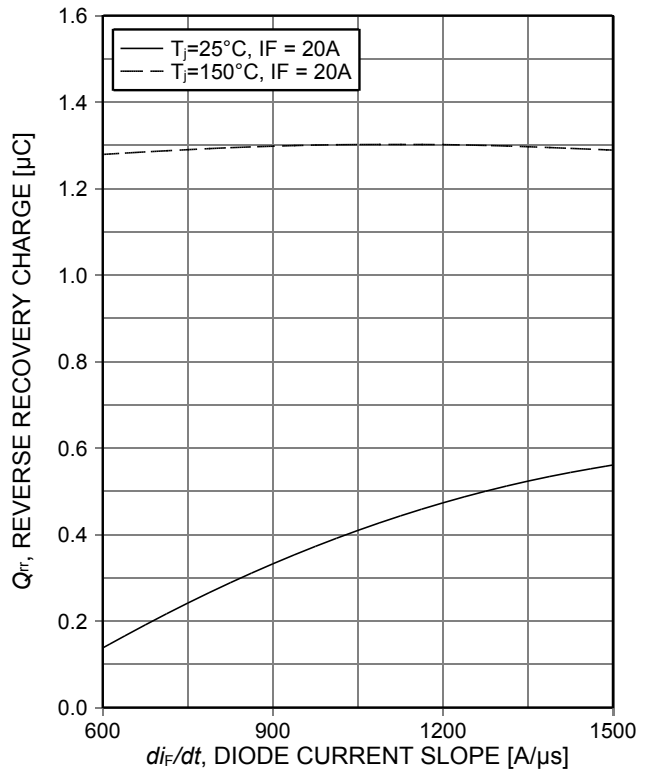

Figure 22. **Typical reverse recovery charge as a function of diode current slope**  
( $V_R=400V$ , Dynamic test circuit in Figure E)

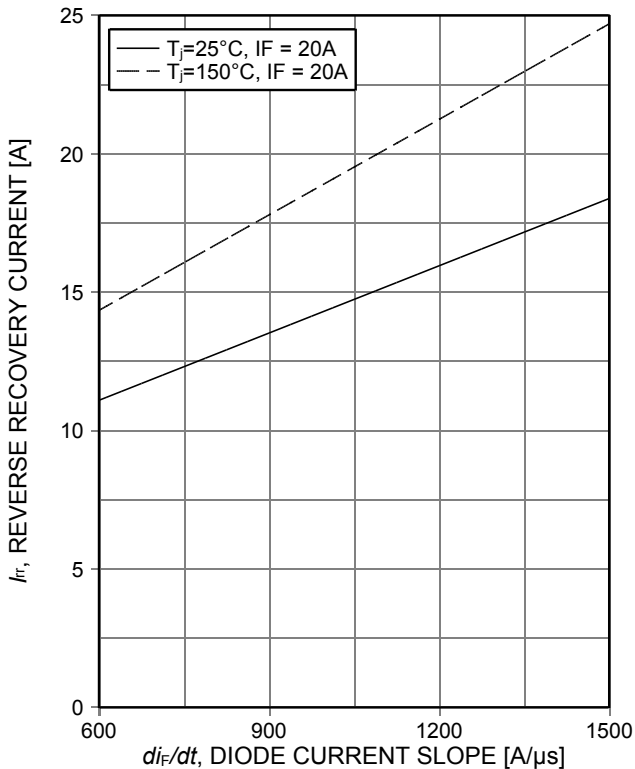

Figure 23. **Typical reverse recovery current as a function of diode current slope**  
( $V_R=400V$ , Dynamic test circuit in Figure E)

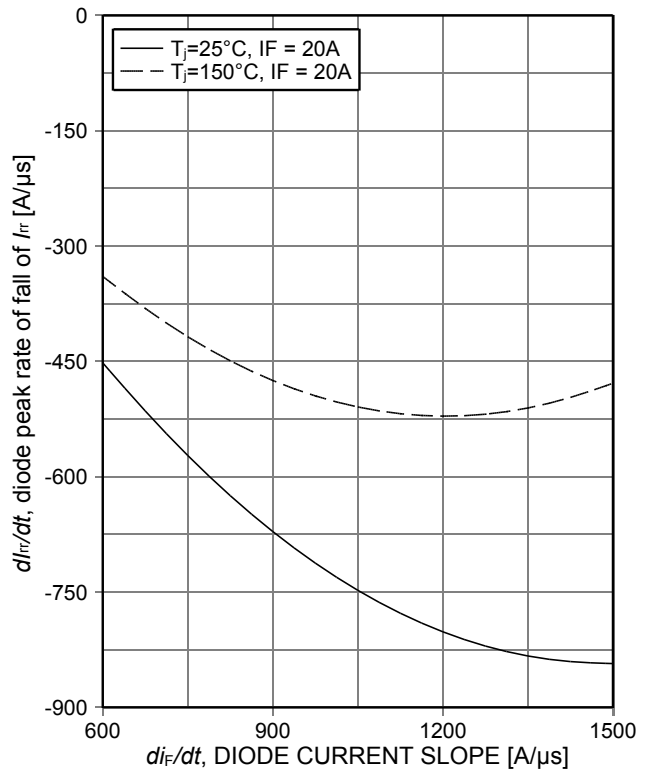

Figure 24. **Typical diode peak rate of fall of reverse recovery current as a function of diode current slope**  
( $V_R=400V$ , Dynamic test circuit in Figure E)

TRENCHSTOP™ Series

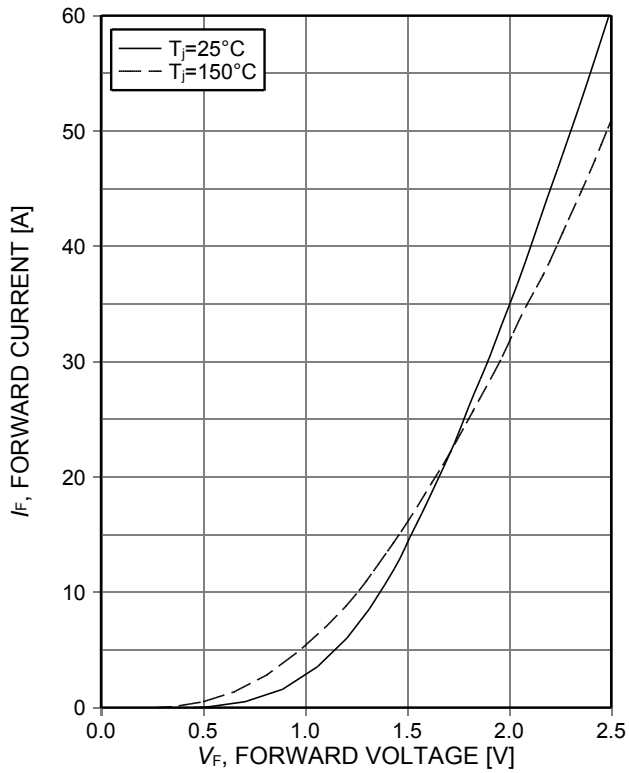

Figure 25. Typical diode forward current as a function of forward voltage

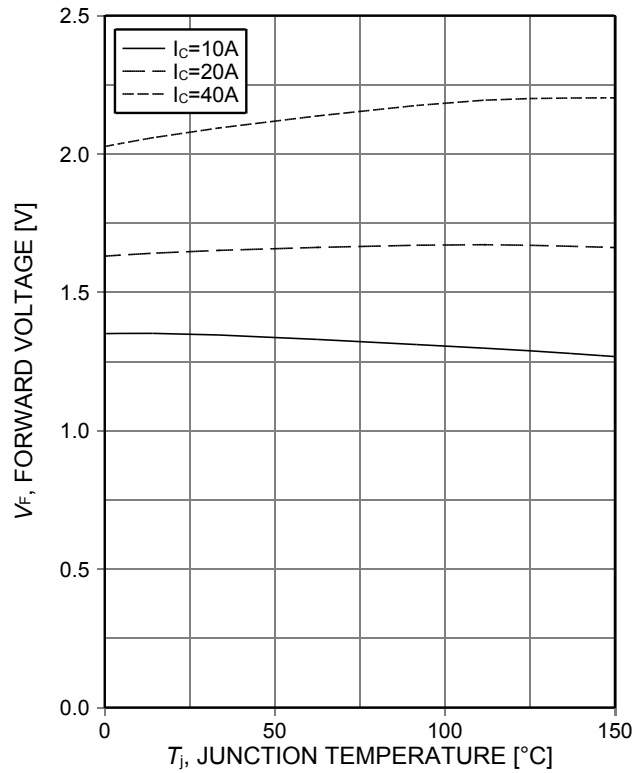
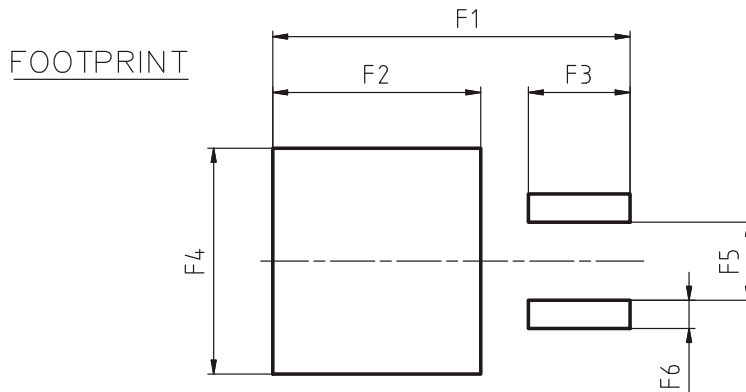
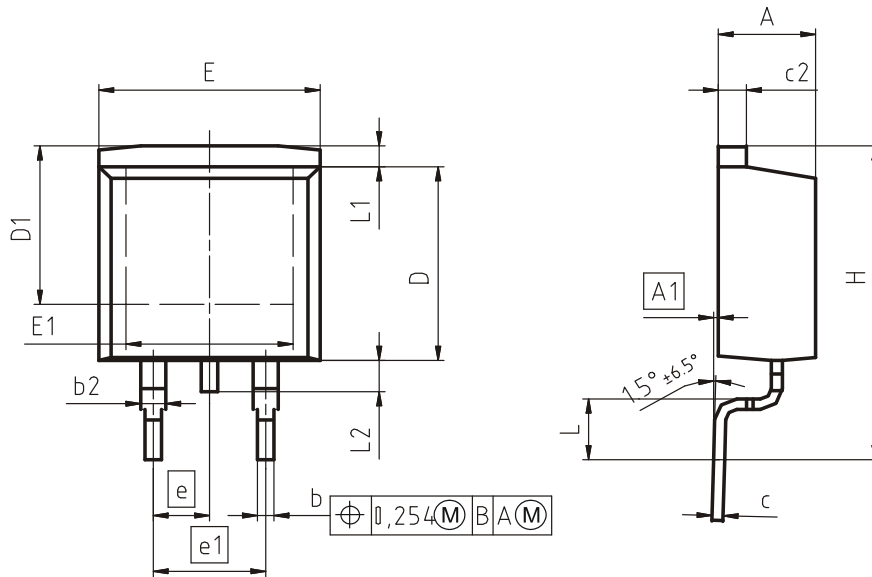

Figure 26. Typical diode forward voltage as a function of junction temperature

Package Drawing PG-TO263-3



DIM	MILLIMETERS		INCHES	
	MIN	MAX	MIN	MAX
A	4.30	4.57	0.169	0.180
A1	0.00	0.25	0.000	0.010
b	0.65	0.85	0.026	0.033
b2	0.95	1.15	0.037	0.045
c	0.33	0.65	0.013	0.026
c2	1.17	1.40	0.046	0.055
D	8.51	9.45	0.335	0.372
D1	7.10	7.90	0.280	0.311
E	9.80	10.31	0.386	0.406
E1	6.50	8.60	0.256	0.339
e	2.54		0.100	
e1	5.08		0.200	
N	2		2	
H	14.61	15.88	0.575	0.625
L	2.29	3.00	0.090	0.118
L1	0.70	1.60	0.028	0.063
L2	1.00	1.78	0.039	0.070
F1	16.05	16.25	0.632	0.640
F2	9.30	9.50	0.366	0.374
F3	4.50	4.70	0.177	0.185
F4	10.70	10.90	0.421	0.429
F5	3.65	3.85	0.144	0.152
F6	1.25	1.45	0.049	0.057

DOCUMENT NO.  
Z8B00003324

SCALE

7.5mm

EUROPEAN PROJECTION

ISSUE DATE  
30-08-2007

REVISION  
01

Testing Conditions



Figure A. Definition of switching times



Figure B. Definition of switching losses



Figure C. Definition of diode switching characteristics



Figure D. Thermal equivalent circuit



Figure E. Dynamic test circuit  
Parasitic inductance  $L_{\sigma}$ ,  
parasitic capacitor  $C_{\sigma}$ ,  
relief capacitor  $C_r$ ,  
(only for ZVT switching)

---

TRENCHSTOP™ Series

## Revision History

---

AIKB20N60CT

**Revision: 2017-02-09, Rev. 2.1**

---

Previous Revision

Revision	Date	Subjects (major changes since last revision)
2.1	2017-02-09	Data sheet created

### **Trademarks of Infineon Technologies AG**

μHVIC™, μIPM™, μPFC™, AU-ConvertIR™, AURIX™, C166™, CanPAK™, CIPOS™, CIPURSE™, CoolDP™, CoolGaN™, COOLIR™, CoolMOS™, CoolSET™, CoolSiC™, DAVE™, DI-POL™, DirectFET™, DrBlade™, EasyPIM™, EconoBRIDGE™, EconoDUAL™, EconoPACK™, EconoPIM™, EiceDRIVER™, eupec™, FCOS™, GaNpowIR™, HEXFET™, HITFET™, HybridPACK™, iMOTION™, IRAM™, ISOFACE™, IsoPACK™, LEDriviR™, LITIX™, MIPAQ™, ModSTACK™, my-d™, NovalithIC™, OPTIGA™, OptiMOS™, ORIGA™, PowIRaudio™, PowIRstage™, PrimePACK™, PrimeSTACK™, PROFET™, PRO-SIL™, RASIC™, REAL3™, SmartLEWIS™, SOLID FLASH™, SPOC™, StrongIRFET™, SupIRBuck™, TEMPFET™, TRENCHSTOP™, TriCore™, UHVIC™, XHP™, XMC™

Trademarks updated November 2015

### **Other Trademarks**

All referenced product or service names and trademarks are the property of their respective owners.

**Published by**  
**Infineon Technologies AG**  
**81726 München, Germany**  
**© Infineon Technologies AG 2017.**  
**All Rights Reserved.**

### **Important Notice**

The information given in this document shall in no event be regarded as a guarantee of conditions or characteristics ("Beschaffenheitsgarantie"). With respect to any examples, hints or any typical values stated herein and/or any information regarding the application of the product, Infineon Technologies hereby disclaims any and all warranties and liabilities of any kind, including without limitation warranties of non-infringement of intellectual property rights of any third party.

In addition, any information given in this document is subject to customer's compliance with its obligations stated in this document and any applicable legal requirements, norms and standards concerning customer's products and any use of the product of Infineon Technologies in customer's applications.

The data contained in this document is exclusively intended for technically trained staff. It is the responsibility of customer's technical departments to evaluate the suitability of the product for the intended application and the completeness of the product information given in this document with respect to such application.

For further information on the product, technology, delivery terms and conditions and prices please contact your nearest Infineon Technologies office ([www.infineon.com](http://www.infineon.com)).

### **Warnings**

Due to technical requirements products may contain dangerous substances. For information on the types in question please contact your nearest Infineon Technologies office.

Except as otherwise explicitly approved by Infineon Technologies in a written document signed by authorized representatives of Infineon Technologies, Infineon Technologies' products may not be used in any applications where a failure of the product or any consequences of the use thereof can reasonably be expected to result in personal injury.