

KEMET Part Number: PZB300MC11R30
(P300PL104M275AC222)

PZB300/P300, Film, Metallized Paper, Safety, 0.1 uF, 20%, 100C, Lead Spacing = 20mm

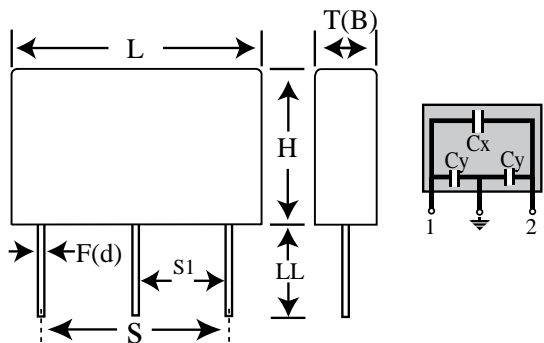

Note: '()' correspond to the letters used in the product bulletin

General Information

Supplier:	KEMET
Series:	PZB300/P300
Dielectric:	Metallized Paper
Style:	Radial
Features:	EMI Safety
RoHS:	Yes
Lead:	3 Leads
Qualifications:	ENEC, UL, cUL
Construction:	Molded
Miscellaneous:	y2_cap_value= 0.0022 uF

Dimensions

L	24mm MAX
H	16mm MAX
T	12.5mm MAX
S	20mm +/-0.5mm
S1	10mm NOM
LL	30mm +5mm
F	0.8mm +/-0.05mm

Specifications

Capacitance:	0.1 uF
Capacitance Tolerance:	20%
Voltage AC:	275 VAC
Temperature Range:	-40/+100C
Rated Temperature:	100C
Dissipation Factor:	1.3% 1kHz
Insulation Resistance:	12 GOhms
Max dV/dt:	600 V/us
Safety Class:	Delta EMI X2+Y2+Y2

Packaging Specifications

Packaging:	Bulk, Bag
Packaging Quantity:	150