

ALM-2812

Dual-Band (2.4-2.5) GHz & (4.9-6) GHz
WLAN Low-Noise Amplifier



Data Sheet

Description

Avago Technologies' ALM-2812 is a dual-band LNA designed for WLAN applications in the (2.4 - 2.5)GHz and (4.9-6)GHz frequency ranges. The LNA uses Avago Technologies' proprietary GaAs Enhancement-mode pHEMT process to achieve high-frequency wideband operation with very low noise figures.

The ALM-2812 has two individual LNAs housed in a 3mm x 3mm package, each one switchable using a single CMOS-compatible pin. All matching components are inside the module. Only one external low frequency bypass capacitor is required for proper operation, making it suitable for use in ultra-miniature WLAN cards and access points.

Surface Mount

3.0 x 3.0 x 1.1 mm³
MCOB



Top View

Note: Package marking provides orientation and identification

- "C" = Product Code
- "ML" = Manufacturing Location
- "Y" = Year
- "WW" = Work Week
- "DD" = Day
- "XXXX" = Lot Number

Pin Configuration

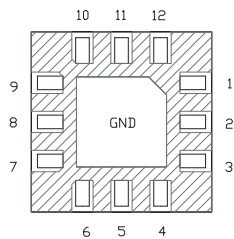

Bottom view

- LNA I/O's:
- 1. RF_OUT_52
 - 3. RF_OUT_24
 - 5. VCC2
 - 6. LNA_ON_24
 - 7. RF_IN_24
 - 9. RF_IN_52
 - 10. LNA_ON_52
 - 11. VCC1
 - 2, 4, 8 & 12. GND

Features

- Advanced GaAs E-pHEMT
- Low Noise: 0.8dB Typ for 2.4 - 2.5 GHz
- Low Noise: 1.4dB Typ for 4.9 - 6 GHz
- Wide Supply Voltage: 2 to 3.6V
- 50 Ohm matched Input & Output
- High Input P1dB and IIP3
- Power Shutdown Function
- RoHS Compliant
- Small Footprint: 3x3mm²
- Low Profile: 1.1mm max.
- Minimal External Components

Typical Specifications (25°C):

At 2.45 GHz, 3.3V 15mA

- Gain = 16.7 dB
- NF = 0.8 dB
- IIP3 = 6.1 dBm
- IP1dB = -5.8 dBm

At 5.5 GHz, 3.3V 23.4mA

- Gain = 23.2dB
- NF = 1.4 dB
- IIP3 = -2.2 dBm
- IP1dB = -12.8dBm

Absolute Maximum Ratings [1]

Parameter	Symbol	Units	Absolute Maximum
Drain – Source Voltage ^[2]	V_{DS}	V	3.6
2G Drain Current ^[2]	I_{DS_2G}	mA	30
5G Drain Current ^[2]	I_{DS_5G}	mA	45
Total Power Dissipation ^[3]	P_{diss}	W	0.2
RF Input Power	$P_{in\ max.}$	dBm	5
Channel Temperature	T_{CH}	*C	150
Storage Temperature	T_{STG}	*C	-65 to 150
Thermal Resistance ^[4]	θ_{ch_b}	*C/W	29.9

Notes:

1. Operation of this device above any one of these parameters may cause permanent damage.
2. Assuming DC quiescent conditions.
3. Board (package belly) temperature T_B is 25°C. Derate 33.4mW/°C for $T_B > 144$ °C.
4. Channel-to-board thermal resistance measured using 150°C Liquid Crystal Measurement method.

Product Consistency Distribution Charts [5,6]

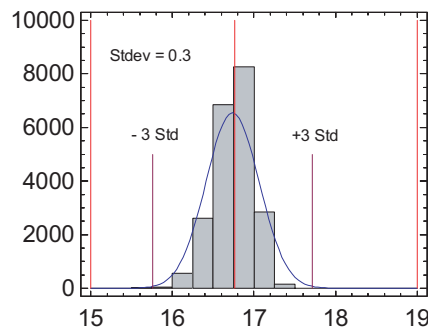

Figure 1. Gain @ 2.45GHz; LSL = 15dB, Nominal = 16.7dB, USL = 18.5dB

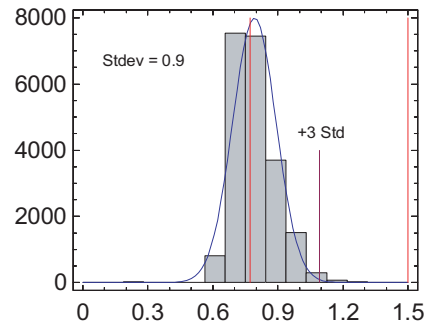

Figure 2. NF @ 2.45GHz; Nominal = 0.8dB, USL = 1.5dB

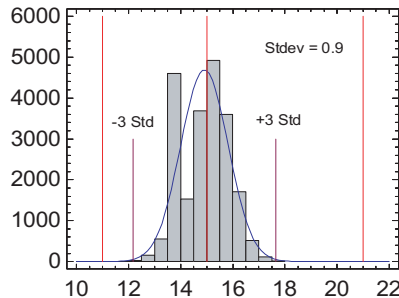

Figure 3. I_{ds} @ 2.45GHz; LSL = 11mA, Nominal = 15mA, USL = 21mA

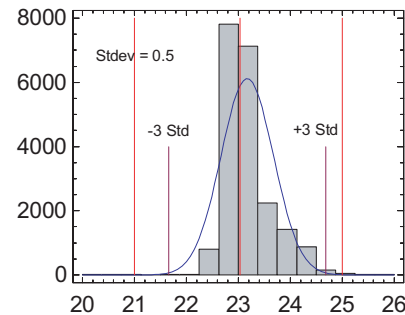

Figure 4. Gain @ 5.5GHz; LSL = 21dB, Nominal = 23.2dB, USL = 25dB

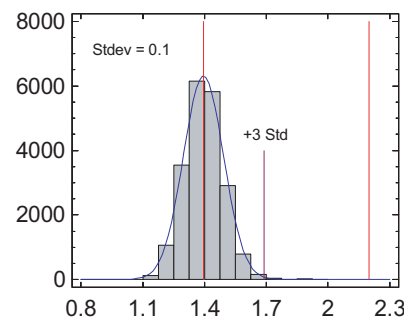

Figure 5. NF @ 5.5GHz; Nominal = 1.4dB, USL = 1.9dB

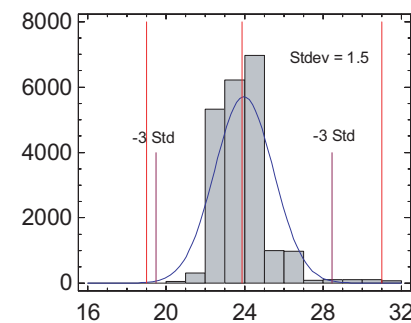

Figure 6. I_{ds} @ 5.5GHz; LSL = 19mA, Nominal = 23.4mA, USL = 31mA

Note:

5. Distribution data sample size is 18K samples taken from 3 different wafers and 3 different lots. Future wafers allocated to this product may have nominal values anywhere between the upper and lower limits.
6. Measurements are made on production test board, which represents a trade-off between optimal Gain, NF, IIP3, IP1 dB and VSWR. Circuit losses have been de-embedded from actual measurements.

Electrical Specifications^[7,8]

TA = 25 °C, DC bias for RF parameter is Vds = 3.3V (unless otherwise specified)

2.4 to 2.5 GHz Band

Parameter and Test Condition	Symbol	Units	Production Min ^[7,8]	2.45GHz (Typ.) 25 Deg	Production Max ^[7,8]
Gain	G	dB	15	16.7	18.5
Noise Figure	NF	dB	-	0.8	1.5
Gain Flatness	Gf	dB		0.1	
Input 1dB Compressed Power	IP1dB	dBm		- 5.8	
Input 3rd Order Intercept Point	IIP3	dBm		6.1	
Input Return Loss	S11	dB		- 10.4	
Output Return Loss	S22	dB		- 16.8	
Rejection, out-of-band (refer to the mid-band level (2.45GHz))					
1 GHz		dB		26	
1.75 GHz		dB		7.8	
2 GHz		dB		4.2	
3.2 GHz		dB		8.5	
4 GHz		dB		24.6	
Supply Current	Ids	mA	11	15	21
Shutdown Current @ V_LNA_24_ON = 0V	Ish	uA		1.5	
Supply Voltage	Vds	V		3.3	

4.9 to 6 GHz Band

Parameter and Test Condition	Symbol	Units	Production Min ^[7,8]	5.5 GHz (Typ.) 25 Deg	Production Max ^[7,8]
Gain	G	dB	21	23.2	25
Noise Figure	NF	dB	-	1.4	1.9
Gain Flatness	Gf	dB		0.3	
Input 1dB Compressed Power	IP1dB	dBm		- 12.8	
Input 3rd Order Intercept Point [1,2]	IIP3	dBm		- 2.2	
Input Return Loss	S11	dB		- 6.1	
Output Return Loss	S22	dB		- 11.5	
Rejection, out-of-band (refer to the mid-band level (5.5 GHz))					
3.7 GHz		dB		12.7	
7.5 GHz		dB		7	
Supply Current	Ids	mA	19	23.4	31
Shutdown Current @ V_LNA_ON_52 = 0V	Ish	uA		2	
Supply Voltage	Vds	V		3.3	

Notes:

7. The parameters with an indicated Production Limit (Production Min and Production Max) are tested at our production final test with no guardbanding. Production Limits are tighter than Customer Limits to serve as a guardband to guarantee the Customer Limits. Customer Limits will have the following guardband: Gain =±0.5dB, NF=±0.2dB, Ids=±1mA
8. Production Limits are subject to change with customer consensus and approval. Pricing is subject to change based on yield impact.

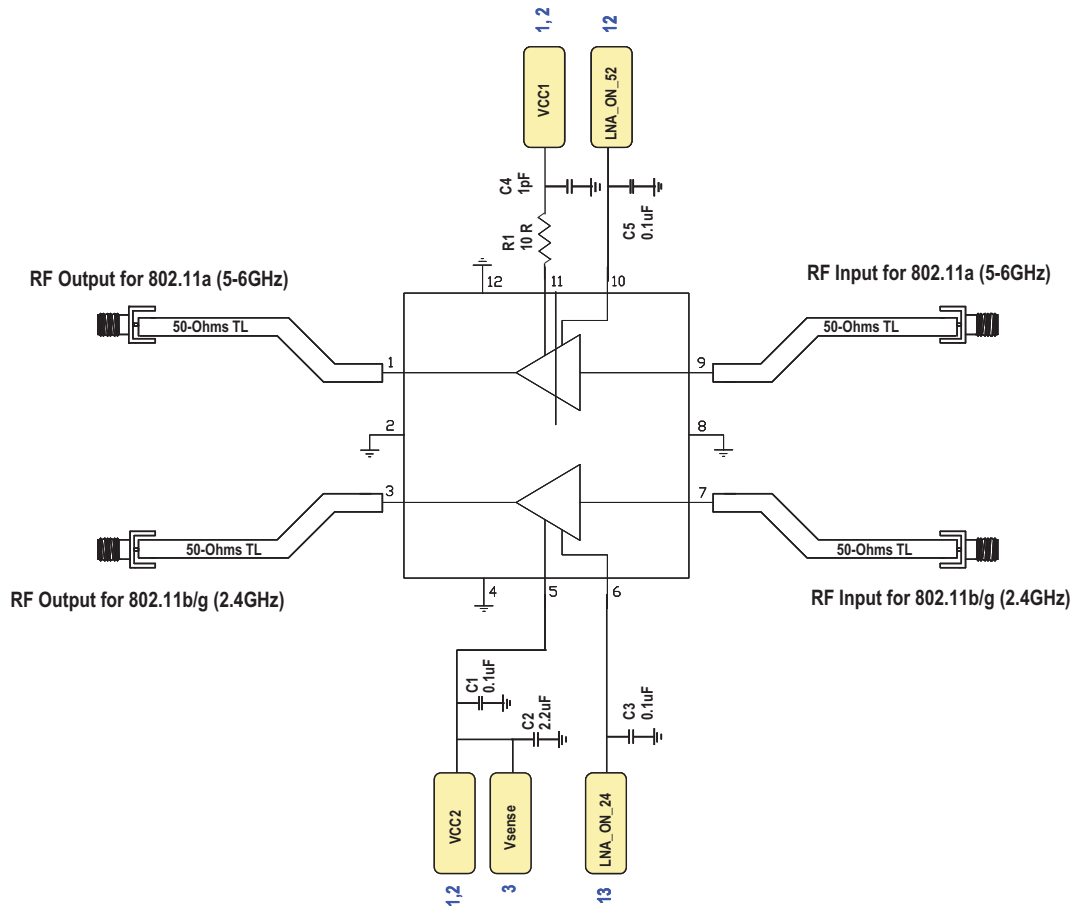

Figure 7. Simplified schematic diagram for demoboard used for Gain, NF, IIP3, IP1dB, Return Loss, Band Rejections and I_{ds} measurement for 2.4G to 2.5GHz band and 4.9G to 6GHz.

ALM-2812 Typical Performance Curves, Vds = 3.3V (At 25°C unless specified otherwise)

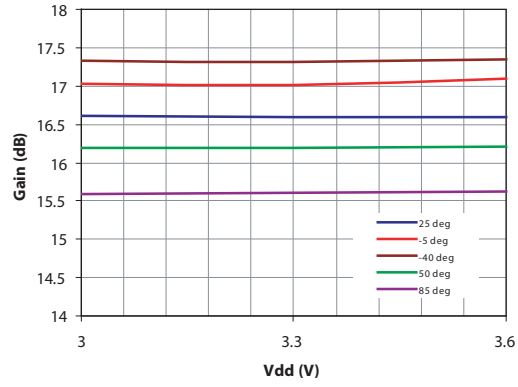

Figure 8. Gain @ 2.45GHz vs Vds vs Temp

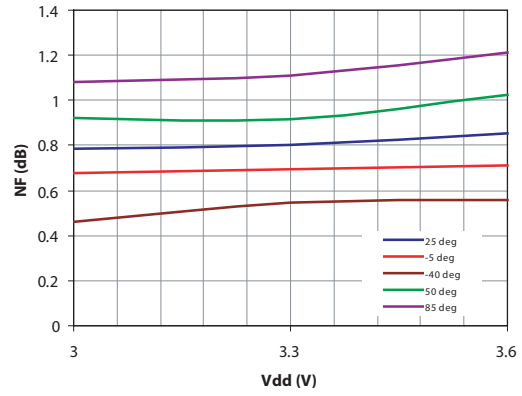

Figure 9. NF @ 2.45GHz vs Vds vs Temp

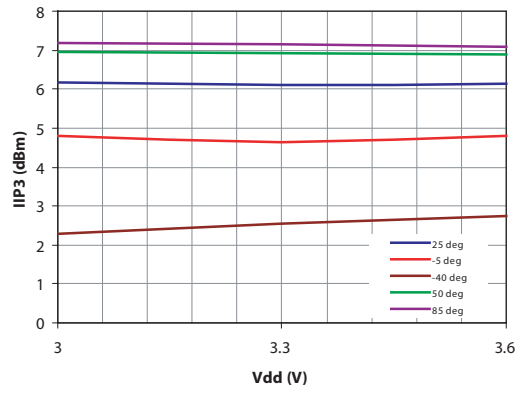

Figure 10. IIP3 @ 2.45GHz vs Vds vs Temp

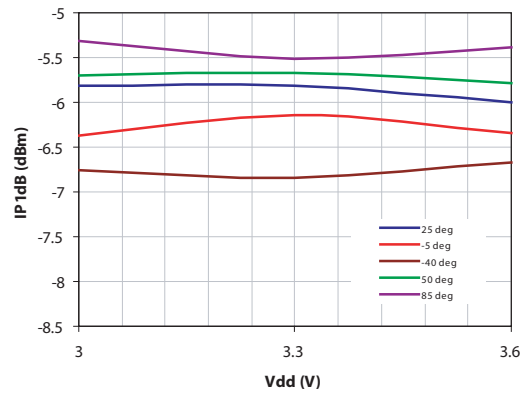

Figure 11. IP1dB @ 2.45GHz vs Vds vs Temp

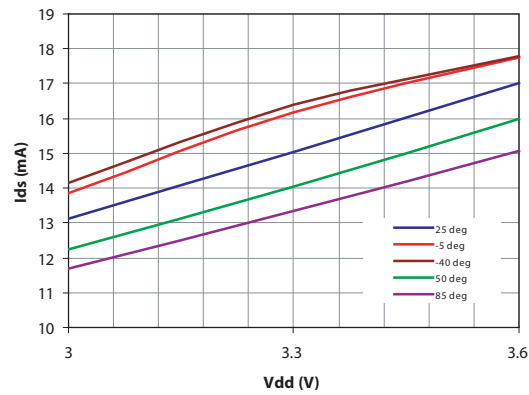

Figure 12. Ids @ 2.45GHz vs Vds vs Temp

ALM-2812 Typical Performance Curves, Vds = 3.3V (At 25°C unless specified otherwise)

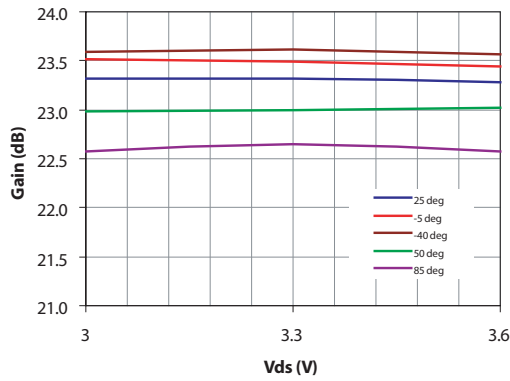

Figure 13. Gain @ 5.5GHz vs Vds vs Temp

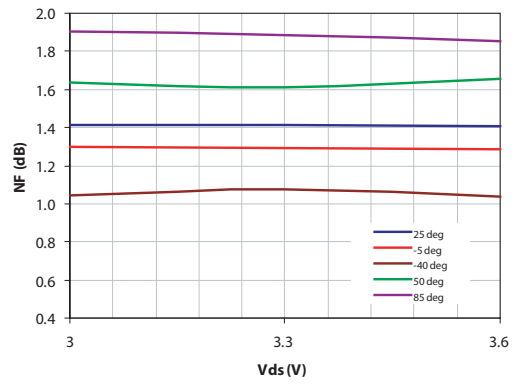

Figure 14. NF @ 5.5GHz vs Vds vs Temp

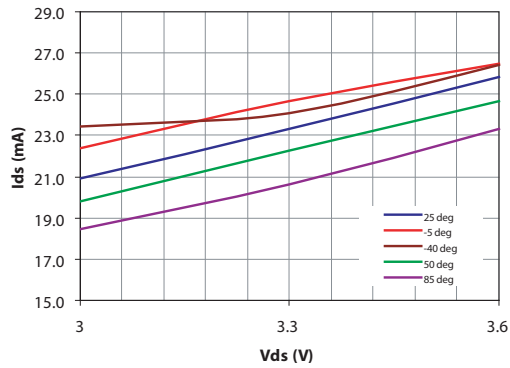

Figure 15. IIP3 @ 5.5GHz vs Vds vs Temp

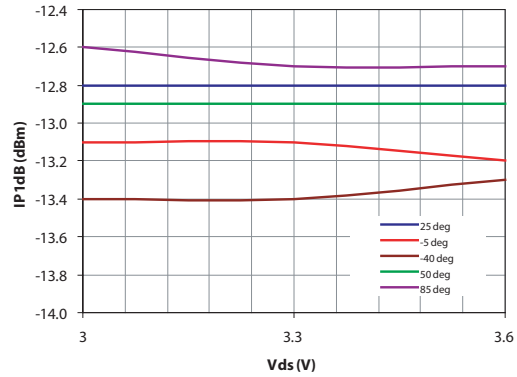

Figure 16. IP1dB @ 5.5GHz vs Vds vs Temp

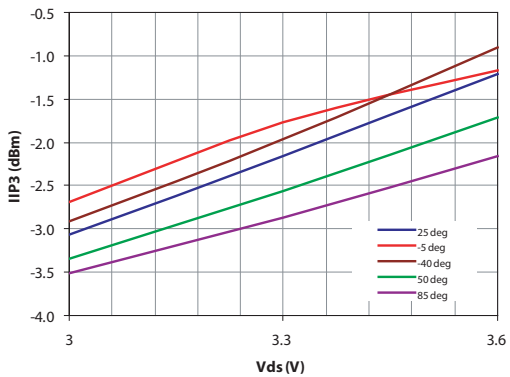

Figure 17. Ids @ 5.5GHz vs Vds vs Temp

2.4 to 2.5GHz Band Typical Scattering Parameters at 25°C, V_{DS} = 3.3V, I_{DS} = 15 mA

freq	S(1,1)	S(2,1)	S(1,2)	S(2,2)
100. MHz	-129.m / 164.	-64.6 / -6.16	-65.1 / 55.7	5.93m / -15.3
300. MHz	-211.m / 132.	-36.6 / 26.2	-65.6 / -39.1	-23.2m / -46.4
500. MHz	-264.m / 98.7	-23.1 / 166.m	-61.2 / -115.	-77.6m / -77.4
700. MHz	-355.m / 62.4	-11.0 / -37.5	-49.8 / -147.	-200.m / -109.
900. MHz	-684.m / 27.5	-15.6 / -116.	-56.6 / 104.	-305.m / -137.
1.10 GHz	-990.m / -12.7	-5.66 / -98.4	-62.5 / 28.2	-298.m / -168.
1.30 GHz	-1.79 / -57.8	1.15 / -135.	-56.1 / -25.8	-408.m / 161.
1.50 GHz	-3.34 / -103.	5.77 / -173.	-49.7 / -85.9	-601.m / 130.
1.70 GHz	-5.31 / -152.	8.84 / 143.	-44.7 / -122.	-907.m / 97.3
1.90 GHz	-7.59 / 160.	11.2 / 97.2	-40.2 / -157.	-1.53 / 60.1
2.10 GHz	-9.48 / 111.	13.6 / 53.8	-36.5 / 162.	-2.94 / 15.3
2.30 GHz	-10.7 / 54.0	16.1 / 4.01	-34.3 / 115.	-6.63 / -45.6
2.50 GHz	-11.2 / -12.1	16.7 / -53.2	-34.5 / 62.7	-14.0 / -157.
2.70 GHz	-11.0 / -76.0	14.6 / -105.	-38.0 / 25.2	-9.55 / 75.6
2.90 GHz	-9.90 / -127.	12.5 / -142.	-40.8 / 16.5	-6.04 / 12.9
3.10 GHz	-8.85 / -171.	10.4 / 180.	-40.5 / 32.4	-4.49 / -38.2
3.30 GHz	-8.10 / 155.	7.42 / 143.	-35.7 / 27.8	-3.69 / -85.7
3.50 GHz	-7.36 / 126.	2.39 / 110.	-31.9 / -833.m	-3.19 / -131.
3.70 GHz	-7.17 / 101.	-3.44 / 92.3	-28.9 / -24.1	-2.77 / -175.
3.90 GHz	-6.83 / 78.3	-9.12 / 95.9	-26.3 / -51.8	-2.39 / 143.
4.10 GHz	-7.32 / 61.3	-7.13 / 137.	-24.9 / -81.0	-2.08 / 105.
4.30 GHz	-6.83 / 42.5	-3.43 / 140.	-22.1 / -110.	-1.76 / 71.2
4.50 GHz	-7.06 / 29.9	-745.m / 114.	-18.9 / -137.	-1.53 / 39.6
4.70 GHz	-6.00 / 24.3	1.56 / 88.1	-15.9 / -175.	-1.29 / 9.02
4.90 GHz	-2.22 / 211.m	3.18 / 63.8	-14.0 / 118.	-1.33 / -26.0
5.10 GHz	-2.42 / -35.1	5.03 / 43.3	-16.8 / 69.4	-2.50 / -64.8
5.30 GHz	-2.95 / -69.4	6.46 / 23.1	-18.1 / 27.5	-2.99 / -104.
5.50 GHz	-4.73 / -96.1	8.14 / -9.84	-22.7 / -8.49	-3.53 / -157.
5.70 GHz	-6.27 / -123.	9.02 / -47.0	-27.2 / -28.7	-3.46 / 150.
5.90 GHz	-7.55 / -154.	9.15 / -81.9	-28.7 / 635.m	-2.61 / 105.
6.10 GHz	-8.48 / 162.	8.58 / -113.	-23.3 / -40.9	-1.86 / 61.8
6.30 GHz	-9.01 / 118.	7.76 / -139.	-26.9 / -70.7	-2.36 / 31.8
6.50 GHz	-7.97 / 74.7	7.38 / -167.	-25.9 / -64.9	-1.67 / 3.46
6.70 GHz	-6.19 / 31.7	5.97 / 166.	-24.6 / -163.	-3.47 / -24.9
6.90 GHz	-5.39 / 6.19	5.30 / 145.	-35.6 / -111.	-1.80 / -44.7
7.10 GHz	-4.15 / -18.0	4.34 / 122.	-31.1 / -123.	-1.42 / -73.4
7.30 GHz	-3.40 / -39.8	3.96 / 101.	-30.9 / -132.	-1.43 / -98.1
7.50 GHz	-2.79 / -58.5	4.43 / 87.5	-29.0 / -144.	-1.69 / -121.
7.70 GHz	-2.43 / -76.1	4.81 / 73.7	-28.2 / -161.	-1.50 / -141.
7.90 GHz	-2.02 / -92.4	6.01 / 46.7	-27.0 / 177.	-1.64 / -167.
8.10 GHz	-1.72 / -108.	6.88 / 16.9	-25.0 / 156.	-2.31 / 161.
8.30 GHz	-1.35 / -123.	6.36 / -14.2	-23.3 / 127.	-4.22 / 120.
8.50 GHz	-1.27 / -140.	5.34 / -34.7	-24.0 / 98.4	-5.45 / 74.7
8.70 GHz	-1.37 / -158.	5.39 / -55.3	-22.3 / 63.5	-5.12 / 7.27
8.90 GHz	-2.38 / -177.	5.82 / -79.6	-22.8 / 9.56	-4.91 / -43.6
9.00 GHz	-3.20 / 178.	6.81 / -91.9	-26.6 / -15.3	-4.12 / -55.8

Typical Noise Parameters, V_{DS} = 3.3V, I_{DS} = 15mA

Freq	NF
GHz	dB
2.4	0.8
2.45	0.8
2.5	0.8

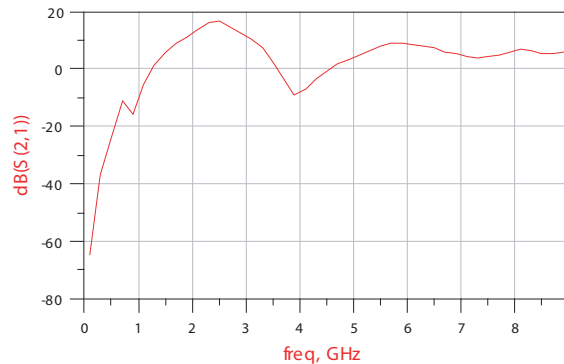

4.9 to 6GHz Band Typical Scattering Parameters at 25°C, V_{DS} = 3.3V, I_{DS} = 23.4mA

freq	S(1,1)	S(2,1)	S(1,2)	S(2,2)
100. MHz	-86.9m / 167.	-63.4 / 25.1	-66.7 / -145.	5.07m / -14.4
300. MHz	-136.m / 141.	-54.9 / -11.3	-67.5 / -153.	-24.9m / -43.2
500. MHz	-191.m / 115.	-42.4 / -41.6	-80.4 / 1.59	-92.4m / -71.8
700. MHz	-229.m / 89.2	-33.4 / -72.2	-64.7 / -154.	-217.m / -101.
900. MHz	-233.m / 62.6	-27.0 / -111.	-58.5 / 179.	-375.m / -129.
1.10 GHz	-368.m / 36.1	-21.2 / -146.	-53.7 / 146.	-576.m / -156.
1.30 GHz	-285.m / 8.05	-15.5 / 170.	-50.0 / 107.	-796.m / 179.
1.50 GHz	-353.m / -20.2	-12.6 / 125.	-47.5 / 52.6	-768.m / 155.
1.70 GHz	-342.m / -48.9	-11.4 / 80.9	-48.1 / 17.1	-595.m / 129.
1.90 GHz	-345.m / -77.8	-11.0 / 41.5	-49.5 / -15.4	-505.m / 102.
2.10 GHz	-369.m / -107.	-10.8 / 12.8	-53.6 / -45.6	-570.m / 74.3
2.30 GHz	-326.m / -136.	-10.9 / -8.43	-54.0 / -34.8	-855.m / 44.4
2.50 GHz	-318.m / -166.	-14.2 / 5.68	-44.8 / -9.14	-1.57 / 13.7
2.70 GHz	-841.m / 164.	-5.10 / 5.61	-36.5 / -70.7	-2.41 / -10.6
2.90 GHz	-1.42 / 145.	-3.35 / -19.0	-38.8 / -156.	-2.07 / -43.2
3.10 GHz	-776.m / 119.	6.23 / -46.6	-43.5 / -176.	-2.25 / -75.6
3.30 GHz	-843.m / 92.1	9.23 / -98.7	-43.9 / 167.	-2.31 / -113.
3.50 GHz	-1.10 / 66.2	9.31 / -140.	-45.8 / 153.	-2.54 / -150.
3.70 GHz	-1.31 / 41.1	10.1 / -166.	-42.5 / 128.	-2.60 / 169.
3.90 GHz	-1.67 / 13.2	12.2 / 158.	-43.5 / 108.	-3.31 / 134.
4.10 GHz	-2.23 / -15.8	16.0 / 132.	-43.0 / 97.5	-3.45 / 102.
4.30 GHz	-3.10 / -49.1	17.6 / 102.	-44.8 / 72.8	-3.49 / 70.2
4.50 GHz	-4.48 / -89.1	19.3 / 57.4	-44.8 / 34.5	-4.06 / 37.2
4.70 GHz	-7.66 / -142.	21.1 / 21.0	-39.6 / -2.04	-6.52 / 21.3
4.90 GHz	-10.4 / 170.	21.8 / -27.6	-47.8 / -111.	-8.39 / -12.0
5.10 GHz	-11.0 / 111.	21.7 / -60.7	-50.2 / 156.	-11.2 / -18.6
5.30 GHz	-10.1 / 62.9	21.7 / -94.9	-44.9 / 78.3	-13.2 / -26.5
5.50 GHz	-9.04 / 20.7	22.3 / -130.	-42.9 / 35.9	-17.3 / -39.3
5.70 GHz	-8.71 / -20.3	22.9 / -165.	-42.2 / 14.8	-23.7 / -6.49
5.90 GHz	-10.1 / -62.1	22.9 / 157.	-38.1 / -2.20	-18.1 / 31.8
6.10 GHz	-12.4 / -123.	22.9 / 117.	-34.8 / -30.4	-16.8 / 14.8
6.30 GHz	-13.8 / 125.	21.7 / 74.4	-31.1 / -70.3	-16.7 / 42.1
6.50 GHz	-11.0 / 25.4	18.7 / 42.4	-30.2 / -137.	-6.61 / 28.9
6.70 GHz	-13.4 / -19.8	17.8 / 24.6	-33.6 / 165.	-3.80 / -20.3
6.90 GHz	-14.7 / -13.4	17.2 / -2.56	-39.6 / 111.	-3.74 / -56.6
7.10 GHz	-13.7 / -513.m	17.0 / -28.1	-44.2 / 74.5	-4.07 / -83.8
7.30 GHz	-9.13 / -15.6	16.5 / -58.3	-50.8 / -2.94	-4.57 / -108.
7.50 GHz	-6.54 / -37.1	16.3 / -83.5	-51.5 / -64.2	-5.25 / -129.
7.70 GHz	-5.42 / -58.7	15.6 / -108.	-45.6 / -116.	-6.31 / -148.
7.90 GHz	-5.14 / -80.7	14.9 / -136.	-48.0 / 172.	-7.48 / -170.
8.10 GHz	-5.18 / -93.6	14.7 / -163.	-47.8 / 166.	-10.9 / 167.
8.30 GHz	-4.92 / -108.	13.7 / 169.	-46.5 / 178.	-17.8 / 143.
8.50 GHz	-4.74 / -122.	12.9 / 143.	-45.1 / 135.	-29.0 / -43.5
8.70 GHz	-4.55 / -135.	12.3 / 120.	-45.6 / 145.	-14.1 / -61.2
8.90 GHz	-4.61 / -148.	12.0 / 92.6	-43.4 / 113.	-8.97 / -86.0
9.00 GHz	-4.64 / -155.	11.8 / 76.9	-41.0 / 95.8	-7.49 / -97.6

Typical Noise Parameters, V_{DS} = 3.3V, I_{DS} = 23.4mA

Freq	NF
GHz	dB
4.95	1.6
5.5	1.5
6	1.5

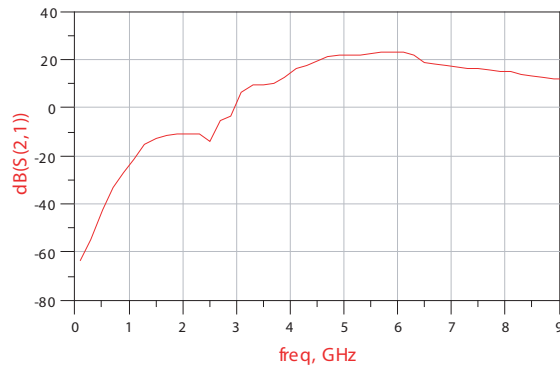

Tape Dimensions

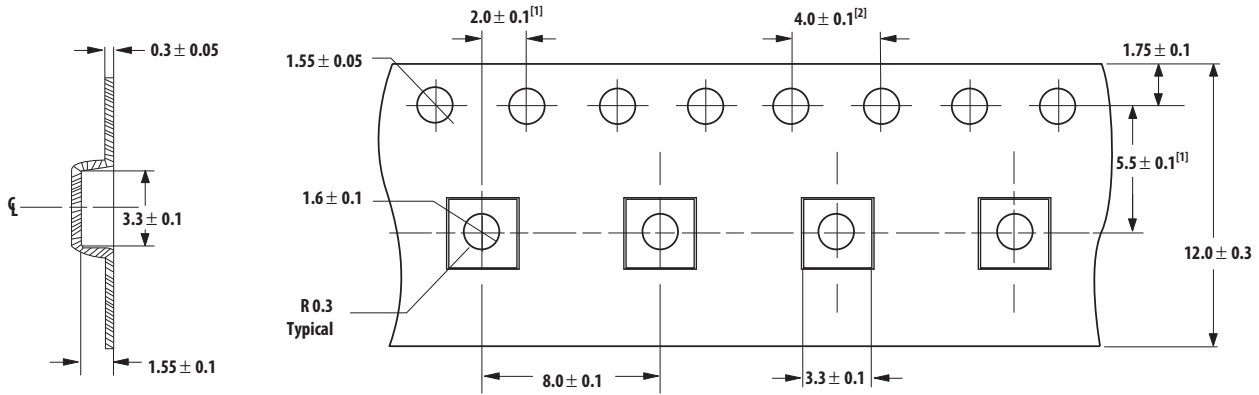

Notes:

1. Measured from centerline of sprocket hole to centerline of pocket
2. Cumulative tolerance of 10 sprocket holes is ± 0.20
3. All dimensions in millimeter unless otherwise stated

Reel Dimensions

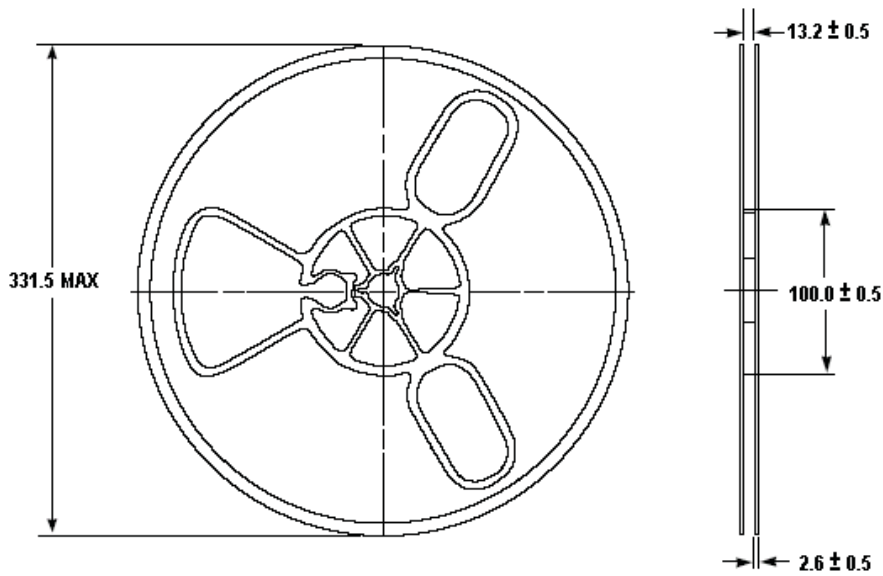

For product information and a complete list of distributors, please go to our web site: www.avagotech.com

Avago, Avago Technologies, and the A logo are trademarks of Avago Technologies in the United States and other countries. Data subject to change. Copyright © 2005-2010 Avago Technologies. All rights reserved.
AV02-0383EN - May 21, 2010

AVAGO
TECHNOLOGIES