

Important notice

Dear Customer,

On 7 February 2017 the former NXP Standard Product business became a new company with the tradename **Nexperia**. Nexperia is an industry leading supplier of Discrete, Logic and PowerMOS semiconductors with its focus on the automotive, industrial, computing, consumer and wearable application markets

In data sheets and application notes which still contain NXP or Philips Semiconductors references, use the references to Nexperia, as shown below.

Instead of <http://www.nxp.com>, <http://www.philips.com/> or <http://www.semiconductors.philips.com/>, use <http://www.nexperia.com>

Instead of sales.addresses@www.nxp.com or sales.addresses@www.semiconductors.philips.com, use salesaddresses@nexperia.com (email)

Replace the copyright notice at the bottom of each page or elsewhere in the document, depending on the version, as shown below:

- © NXP N.V. (year). All rights reserved or © Koninklijke Philips Electronics N.V. (year). All rights reserved

Should be replaced with:

- © **Nexperia B.V. (year). All rights reserved.**

If you have any questions related to the data sheet, please contact our nearest sales office via e-mail or telephone (details via salesaddresses@nexperia.com). Thank you for your cooperation and understanding,

Kind regards,

Team Nexperia

BUK663R5-30C

N-channel TrenchMOS intermediate level FET

Rev. 02 — 16 November 2010

Product data sheet

1. Product profile

1.1 General description

Intermediate level gate drive N-channel enhancement mode Field-Effect Transistor (FET) in a plastic package using advanced TrenchMOS technology. This product has been designed and qualified to the appropriate AEC Q101 standard for use in high performance automotive applications.

1.2 Features and benefits

- AEC Q101 compliant
- Suitable for standard and logic level gate drive sources
- Suitable for thermally demanding environments due to 175 °C rating

1.3 Applications

- 12 V Automotive systems
- Electric and electro-hydraulic power steering
- Motors, lamps and solenoid control
- Start-Stop micro-hybrid applications
- Transmission control
- Ultra high performance power switching

1.4 Quick reference data

Table 1. Quick reference data

Symbol	Parameter	Conditions	Min	Typ	Max	Unit
V_{DS}	drain-source voltage	$T_j \geq 25\text{ °C}; T_j \leq 175\text{ °C}$	-	-	30	V
I_D	drain current	$V_{GS} = 10\text{ V}; T_{mb} = 25\text{ °C};$ see Figure 1	11	-	100	A
P_{tot}	total power dissipation	$T_{mb} = 25\text{ °C};$ see Figure 2	-	-	158	W
Static characteristics						
$R_{DS(on)}$	drain-source on-state resistance	$V_{GS} = 10\text{ V}; I_D = 25\text{ A};$ $T_j = 25\text{ °C};$ see Figure 11	-	2.9	3.5	mΩ



Table 1. Quick reference data ...continued

Symbol	Parameter	Conditions	Min	Typ	Max	Unit
Avalanche ruggedness						
$E_{DS(AL)S}$	non-repetitive drain-source avalanche energy	$I_D = 100\text{ A}$; $V_{sup} \leq 30\text{ V}$; $R_{GS} = 50\ \Omega$; $V_{GS} = 10\text{ V}$; $T_{j(init)} = 25\text{ }^\circ\text{C}$; unclamped	-	-	242	mJ
Dynamic characteristics						
Q_{GD}	gate-drain charge	$I_D = 25\text{ A}$; $V_{DS} = 24\text{ V}$; $V_{GS} = 10\text{ V}$; see Figure 13 ; see Figure 14	-	20	-	nC

[1] Continuous current is limited by package.

2. Pinning information

Table 2. Pinning information

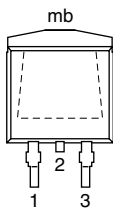
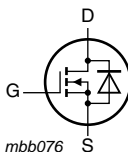
Pin	Symbol	Description	Simplified outline	Graphic symbol
1	G	gate		
2	D	Drain		
3	S	source		
mb	D	mounting base; connected to drain		

SOT404 (D2PAK)

3. Ordering information

Table 3. Ordering information

Type number	Package		Version
	Name	Description	
BUK663R5-30C	D2PAK	plastic single-ended surface-mounted package (D2PAK); 3 leads (one lead cropped)	SOT404

4. Limiting values

Table 4. Limiting values

In accordance with the Absolute Maximum Rating System (IEC 60134).

Symbol	Parameter	Conditions	Min	Max	Unit	
V_{DS}	drain-source voltage	$T_j \geq 25\text{ °C}$; $T_j \leq 175\text{ °C}$	-	30	V	
V_{GS}	gate-source voltage	DC	[1]	-16	16	V
		Pulsed	[2]	-20	20	V
I_D	drain current	$T_{mb} = 25\text{ °C}$; $V_{GS} = 10\text{ V}$; see Figure 1	[3]	-	100	A
		$T_{mb} = 100\text{ °C}$; $V_{GS} = 10\text{ V}$; see Figure 1	[3]	-	100	A
I_{DM}	peak drain current	$T_{mb} = 25\text{ °C}$; $t_p \leq 10\text{ }\mu\text{s}$; pulsed; see Figure 3	-	616	A	
P_{tot}	total power dissipation	$T_{mb} = 25\text{ °C}$; see Figure 2	-	158	W	
T_{stg}	storage temperature		-55	175	°C	
T_j	junction temperature		-55	175	°C	
Source-drain diode						
I_S	source current	$T_{mb} = 25\text{ °C}$	[3]	-	100	A
I_{SM}	peak source current	$t_p \leq 10\text{ }\mu\text{s}$; pulsed; $T_{mb} = 25\text{ °C}$	-	616	A	
Avalanche ruggedness						
$E_{DS(AL)S}$	non-repetitive drain-source avalanche energy	$I_D = 100\text{ A}$; $V_{sup} \leq 30\text{ V}$; $R_{GS} = 50\text{ }\Omega$; $V_{GS} = 10\text{ V}$; $T_{j(init)} = 25\text{ °C}$; unclamped	-	242	mJ	
$E_{DS(AL)R}$	repetitive drain-source avalanche energy		[4][5][6]	-	J	

[1] -16V accumulated duration not to exceed 168 hrs.

[2] Accumulated pulse duration not to exceed 5mins.

[3] Continuous current is limited by package.

[4] Single-pulse avalanche rating limited by maximum junction temperature of 175 °C.

[5] Repetitive avalanche rating limited by an average junction temperature of 170 °C.

[6] Refer to application note AN10273 for further information.

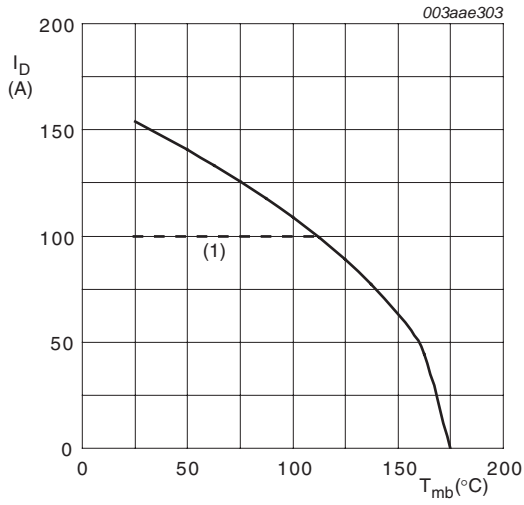

$V_{GS} \geq 10V$
 (1) Capped at 100 A due to package.

Fig 1. Continuous drain current as a function of mounting base temperature

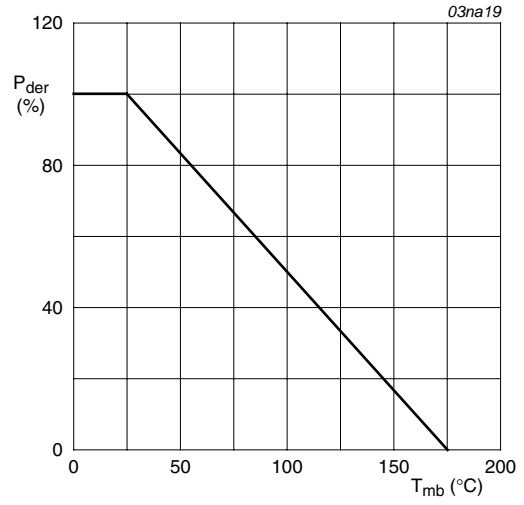

$$P_{der} = \frac{P_{tot}}{P_{tot(25^{\circ}C)}} \times 100\%$$

Fig 2. Normalized total power dissipation as a function of mounting base temperature

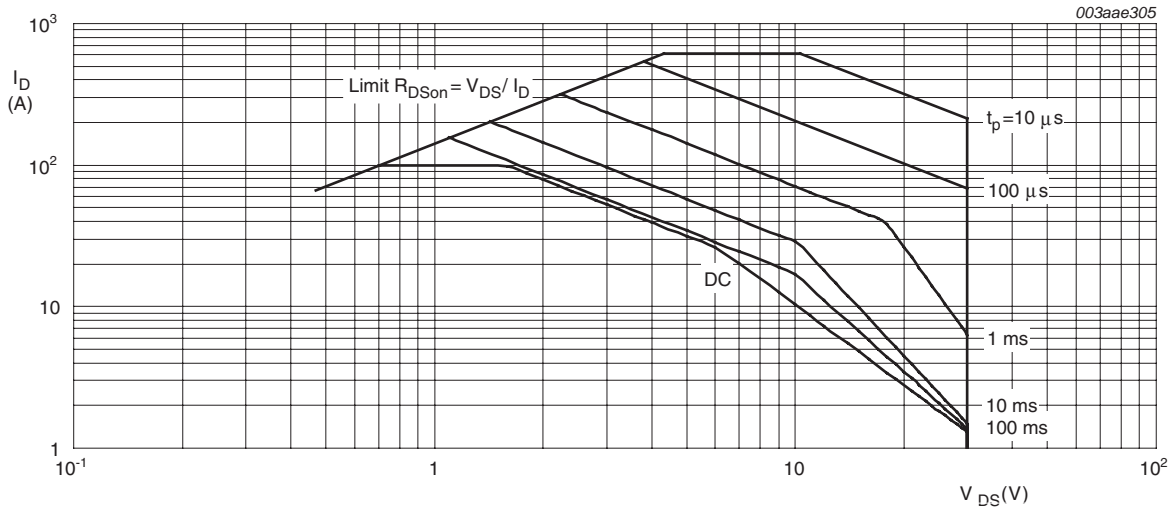

$T_{mb} = 25^{\circ}C$; I_{DM} is a single pulse

Fig 3. Safe operating area; continuous and peak drain currents as a function of drain-source voltage

5. Thermal characteristics

Table 5. Thermal characteristics

Symbol	Parameter	Conditions	Min	Typ	Max	Unit
$R_{th(j-mb)}$	thermal resistance from junction to mounting base	see Figure 4	-	-	0.95	K/W

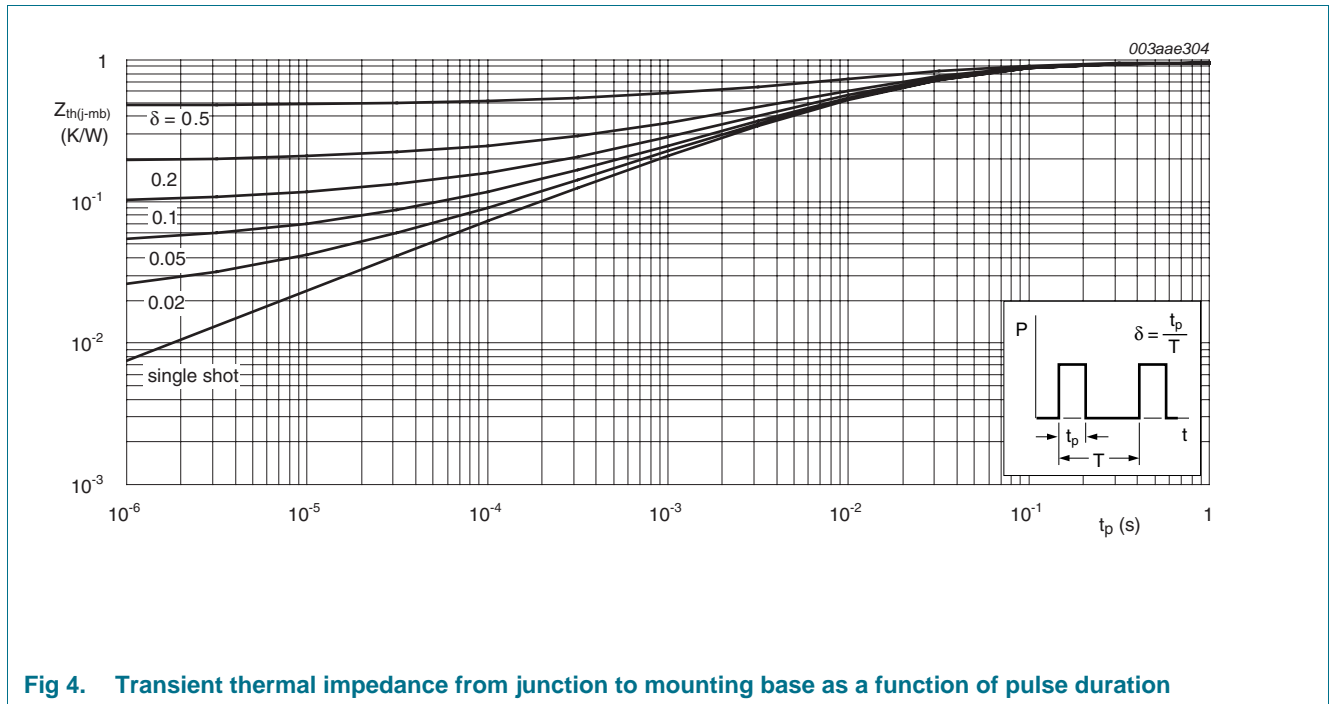

Fig 4. Transient thermal impedance from junction to mounting base as a function of pulse duration

6. Characteristics

Table 6. Characteristics

Symbol	Parameter	Conditions	Min	Typ	Max	Unit
Static characteristics						
$V_{(BR)DSS}$	drain-source breakdown voltage	$I_D = 250 \mu A; V_{GS} = 0 V; T_j = 25 \text{ }^\circ C$	30	-	-	V
		$I_D = 250 \mu A; V_{GS} = 0 V; T_j = -55 \text{ }^\circ C$	27	-	-	V
$V_{GS(th)}$	gate-source threshold voltage	$I_D = 1 \text{ mA}; V_{DS} = V_{GS}; T_j = 25 \text{ }^\circ C$; see Figure 9 ; see Figure 10	1.8	2.3	2.8	V
		$I_D = 1 \text{ mA}; V_{DS} = V_{GS}; T_j = -55 \text{ }^\circ C$; see Figure 9	-	-	3.3	V
		$I_D = 1 \text{ mA}; V_{DS} = V_{GS}; T_j = 175 \text{ }^\circ C$; see Figure 9	0.8	-	-	V
I_{DSS}	drain leakage current	$V_{DS} = 30 V; V_{GS} = 0 V; T_j = 175 \text{ }^\circ C$	-	-	500	μA
		$V_{DS} = 30 V; V_{GS} = 0 V; T_j = 25 \text{ }^\circ C$	-	0.02	1	μA
I_{GSS}	gate leakage current	$V_{DS} = 0 V; V_{GS} = 20 V; T_j = 25 \text{ }^\circ C$	-	2	100	nA
		$V_{DS} = 0 V; V_{GS} = -20 V; T_j = 25 \text{ }^\circ C$	-	2	100	nA
$R_{DS(on)}$	drain-source on-state resistance	$V_{GS} = 10 V; I_D = 25 A; T_j = 25 \text{ }^\circ C$; see Figure 11	-	2.9	3.5	m Ω
		$V_{GS} = 5 V; I_D = 25 A; T_j = 25 \text{ }^\circ C$; see Figure 11	-	4.2	5.2	m Ω
		$V_{GS} = 4.5 V; I_D = 25 A; T_j = 25 \text{ }^\circ C$; see Figure 11	-	4.9	6.5	m Ω
		$V_{GS} = 10 V; I_D = 25 A; T_j = 175 \text{ }^\circ C$; see Figure 12 ; see Figure 11	-	-	6.7	m Ω
Dynamic characteristics						
$Q_{G(tot)}$	total gate charge	$I_D = 25 A; V_{DS} = 24 V; V_{GS} = 10 V$; see Figure 13 ; see Figure 14	-	78	-	nC
		$I_D = 25 A; V_{DS} = 24 V; V_{GS} = 5 V$; see Figure 13 ; see Figure 14	-	45	-	nC
Q_{GS}	gate-source charge	$I_D = 25 A; V_{DS} = 24 V; V_{GS} = 10 V$; see Figure 13 ; see Figure 14	-	15	-	nC
Q_{GD}	gate-drain charge		-	20	-	nC
C_{iss}	input capacitance	$V_{GS} = 0 V; V_{DS} = 25 V; f = 1 \text{ MHz}; T_j = 25 \text{ }^\circ C$; see Figure 15	-	3530	4707	pF
C_{oss}	output capacitance	$V_{GS} = 0 V; V_{DS} = 25 V; f = 1 \text{ MHz}; T_j = 25 \text{ }^\circ C$; see Figure 14	-	623	748	pF
C_{rss}	reverse transfer capacitance	$V_{GS} = 0 V; V_{DS} = 25 V; f = 1 \text{ MHz}; T_j = 25 \text{ }^\circ C$	-	381	522	pF
$t_{d(on)}$	turn-on delay time	$V_{DS} = 25 V; R_L = 1 \text{ } \Omega; V_{GS} = 10 V$; $R_{G(ext)} = 10 \text{ } \Omega$	-	19	-	ns
t_r	rise time		-	54	-	ns
$t_{d(off)}$	turn-off delay time		-	135	-	ns
t_f	fall time		-	83	-	ns
L_D	internal drain inductance	from upper edge of drain mounting base to centre of die ; $T_j = 25 \text{ }^\circ C$	-	3.5	-	nH
L_S	internal source inductance	from source lead to source bond pad ; $T_j = 25 \text{ }^\circ C$	-	7.5	-	nH

Table 6. Characteristics ...continued

Symbol	Parameter	Conditions	Min	Typ	Max	Unit
Source-drain diode						
V_{SD}	source-drain voltage	$I_S = 25\text{ A}$; $V_{GS} = 0\text{ V}$; $T_j = 25\text{ }^\circ\text{C}$; see Figure 16	-	0.8	1.2	V
t_{rr}	reverse recovery time	$I_S = 20\text{ A}$; $di_S/dt = -100\text{ A}/\mu\text{s}$;	-	46	-	ns
Q_r	recovered charge	$V_{GS} = 0\text{ V}$; $V_{DS} = 25\text{ V}$	-	57	-	nC

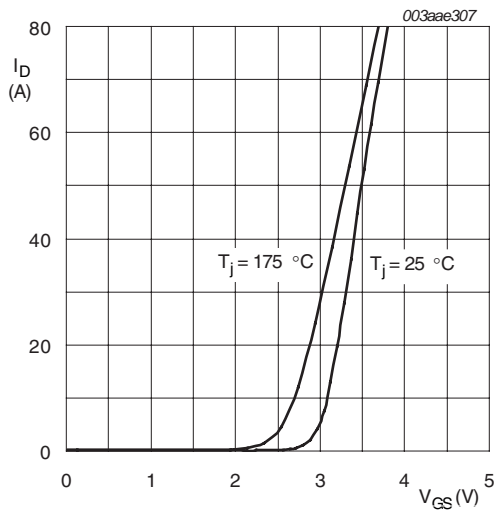

$$V_{DS} > I_D \times R_{Dson}$$

Fig 5. Transfer characteristics: drain current as a function of gate-source voltage; typical values

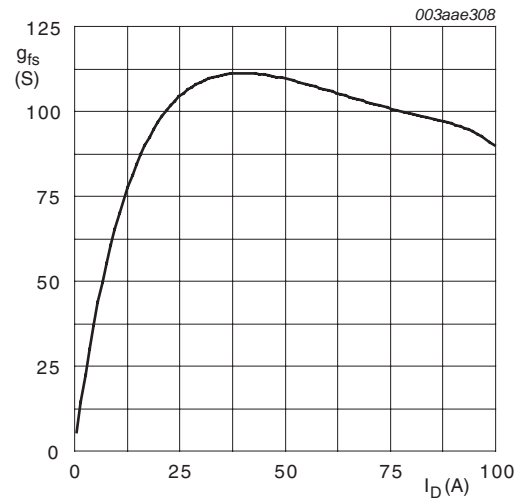

$$T_j = 25\text{ }^\circ\text{C}; V_{DS} = 25\text{ V}$$

Fig 6. Forward transconductance as a function of drain current; typical values

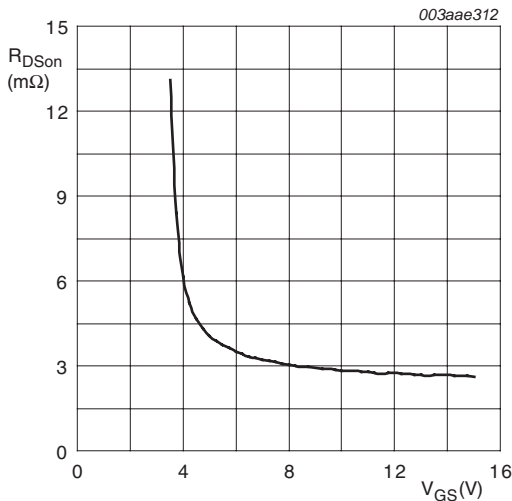

$$T_j = 25\text{ }^\circ\text{C}; I_D = 25\text{ A}$$

Fig 7. Drain-source on-state resistance as a function of gate-source voltage; typical values.

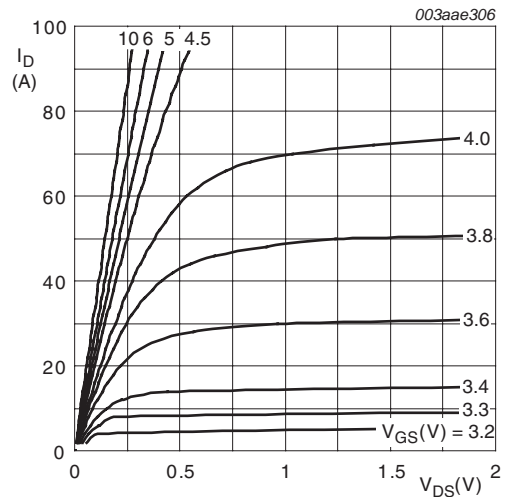

$$T_j = 25\text{ }^\circ\text{C}$$

Fig 8. Output characteristics: drain current as a function of drain-source voltage; typical values

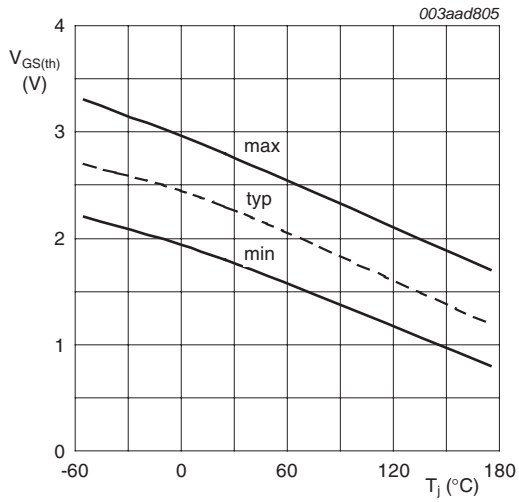

$$I_D = 1\text{mA}; V_{DS} = V_{GS}$$

Fig 9. Gate-source threshold voltage as a function of junction temperature

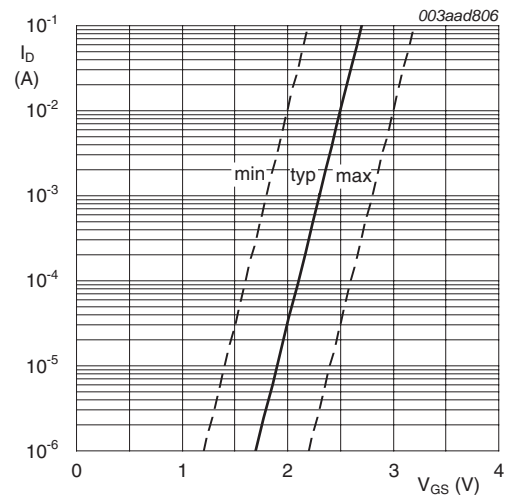

$$T_j = 25^\circ\text{C}; V_{DS} = 5\text{V}$$

Fig 10. Sub-threshold drain current as a function of gate-source voltage

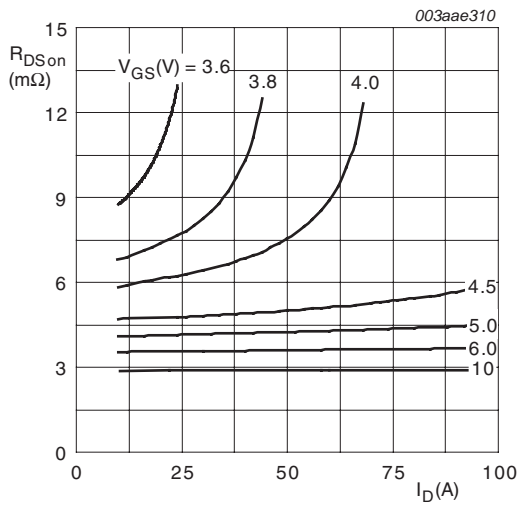

$$T_j = 25^\circ\text{C}$$

Fig 11. Drain-source on-state resistance as a function of drain current; typical values

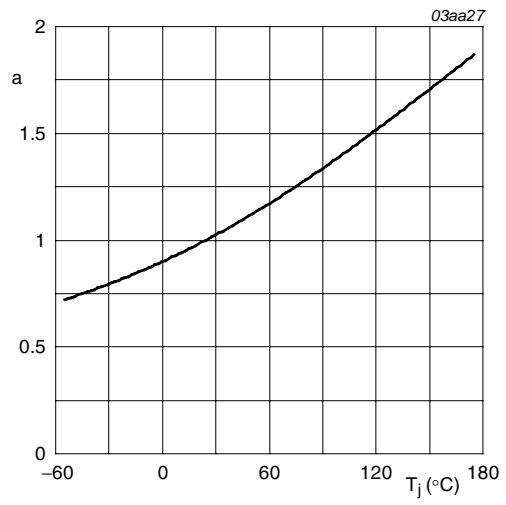

$$a = \frac{R_{DSon}}{R_{DSon(25^\circ\text{C})}}$$

Fig 12. Normalized drain-source on-state resistance factor as a function of junction temperature

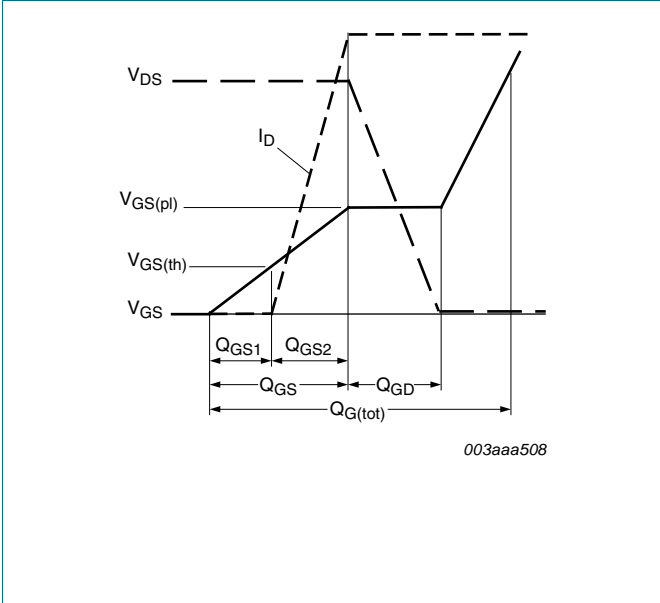

Fig 13. Gate charge waveform definitions

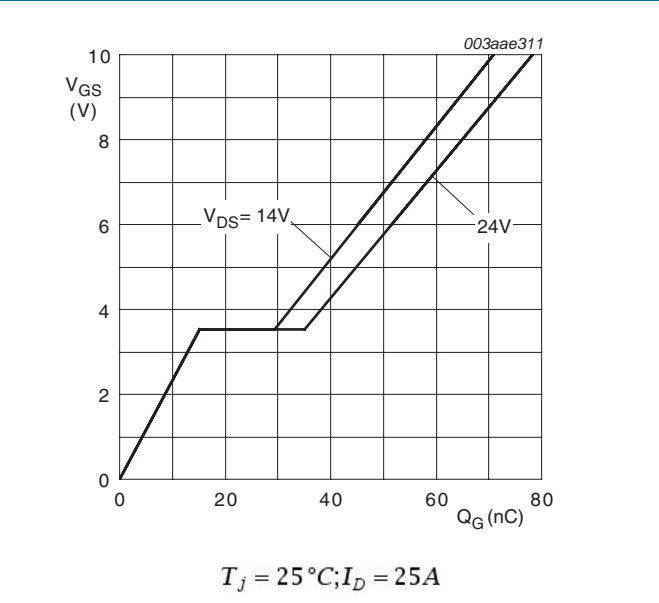

Fig 14. Gate-source voltage as a function of gate charge; typical values

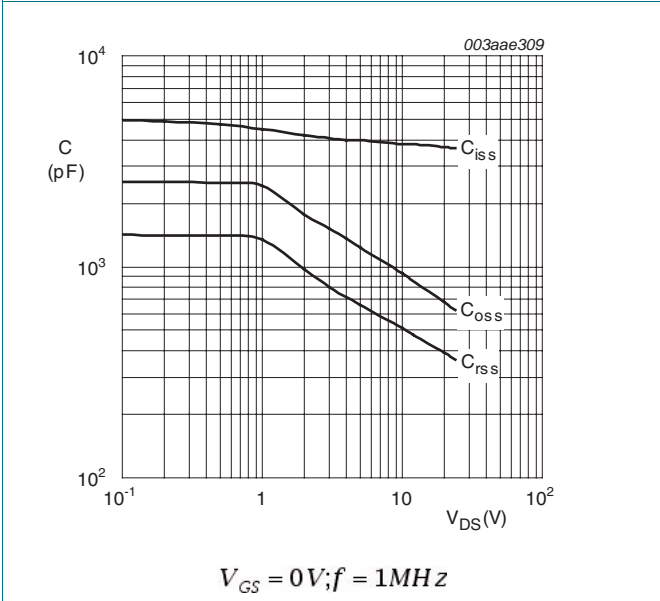

Fig 15. Input, output and reverse transfer capacitances as a function of drain-source voltage; typical values

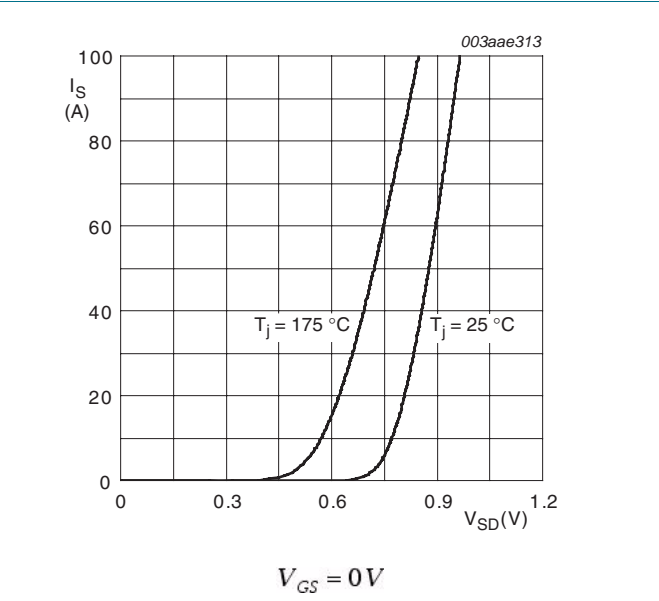

Fig 16. Source current as a function of source-drain voltage; typical values

7. Package outline

Plastic single-ended surface-mounted package (D2PAK); 3 leads (one lead cropped)

SOT404

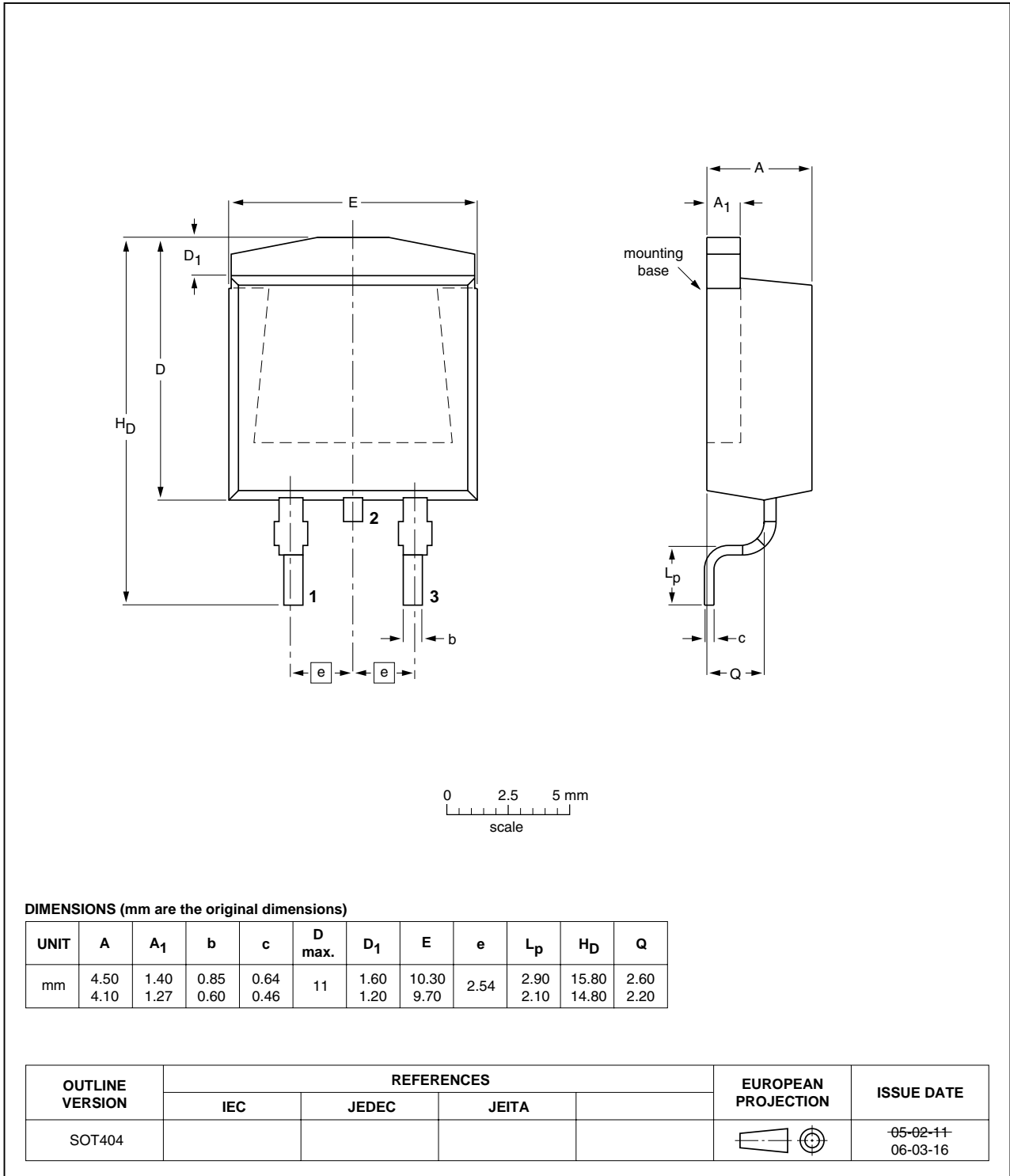

Fig 17. Package outline SOT404 (D2PAK)

8. Revision history

Table 7. Revision history

Document ID	Release date	Data sheet status	Change notice	Supersedes
BUK663R5-30C v.2	20101116	Product data sheet	-	BUK663R5-30C v.1
Modifications:	<ul style="list-style-type: none">• Status changed from objective to product.• Various changes to content.			
BUK663R5-30C v.1	20100521	Objective data sheet	-	-

9. Legal information

9.1 Data sheet status

Document status ^{[1][2]}	Product status ^[3]	Definition
Objective [short] data sheet	Development	This document contains data from the objective specification for product development.
Preliminary [short] data sheet	Qualification	This document contains data from the preliminary specification.
Product [short] data sheet	Production	This document contains the product specification.

[1] Please consult the most recently issued document before initiating or completing a design.

[2] The term 'short data sheet' is explained in section "Definitions".

[3] The product status of device(s) described in this document may have changed since this document was published and may differ in case of multiple devices. The latest product status information is available on the Internet at URL <http://www.nxp.com>.

9.2 Definitions

Draft — The document is a draft version only. The content is still under internal review and subject to formal approval, which may result in modifications or additions. NXP Semiconductors does not give any representations or warranties as to the accuracy or completeness of information included herein and shall have no liability for the consequences of use of such information.

Short data sheet — A short data sheet is an extract from a full data sheet with the same product type number(s) and title. A short data sheet is intended for quick reference only and should not be relied upon to contain detailed and full information. For detailed and full information see the relevant full data sheet, which is available on request via the local NXP Semiconductors sales office. In case of any inconsistency or conflict with the short data sheet, the full data sheet shall prevail.

Product specification — The information and data provided in a Product data sheet shall define the specification of the product as agreed between NXP Semiconductors and its customer, unless NXP Semiconductors and customer have explicitly agreed otherwise in writing. In no event however, shall an agreement be valid in which the NXP Semiconductors product is deemed to offer functions and qualities beyond those described in the Product data sheet.

9.3 Disclaimers

Limited warranty and liability — Information in this document is believed to be accurate and reliable. However, NXP Semiconductors does not give any representations or warranties, expressed or implied, as to the accuracy or completeness of such information and shall have no liability for the consequences of use of such information.

In no event shall NXP Semiconductors be liable for any indirect, incidental, punitive, special or consequential damages (including - without limitation - lost profits, lost savings, business interruption, costs related to the removal or replacement of any products or rework charges) whether or not such damages are based on tort (including negligence), warranty, breach of contract or any other legal theory.

Notwithstanding any damages that customer might incur for any reason whatsoever, NXP Semiconductors' aggregate and cumulative liability towards customer for the products described herein shall be limited in accordance with the *Terms and conditions of commercial sale* of NXP Semiconductors.

Right to make changes — NXP Semiconductors reserves the right to make changes to information published in this document, including without limitation specifications and product descriptions, at any time and without notice. This document supersedes and replaces all information supplied prior to the publication hereof.

Suitability for use in automotive applications — This NXP Semiconductors product has been qualified for use in automotive applications. The product is not designed, authorized or warranted to be suitable for use in medical, military, aircraft, space or life support equipment, nor in applications where failure or malfunction of an NXP Semiconductors product can reasonably be expected to result in personal injury, death or severe property or environmental damage. NXP Semiconductors accepts no liability for inclusion and/or use of NXP Semiconductors products in such equipment or applications and therefore such inclusion and/or use is at the customer's own risk.

Quick reference data — The Quick reference data is an extract of the product data given in the Limiting values and Characteristics sections of this document, and as such is not complete, exhaustive or legally binding.

Applications — Applications that are described herein for any of these products are for illustrative purposes only. NXP Semiconductors makes no representation or warranty that such applications will be suitable for the specified use without further testing or modification.

Customers are responsible for the design and operation of their applications and products using NXP Semiconductors products, and NXP Semiconductors accepts no liability for any assistance with applications or customer product design. It is customer's sole responsibility to determine whether the NXP Semiconductors product is suitable and fit for the customer's applications and products planned, as well as for the planned application and use of customer's third party customer(s). Customers should provide appropriate design and operating safeguards to minimize the risks associated with their applications and products.

NXP Semiconductors does not accept any liability related to any default, damage, costs or problem which is based on any weakness or default in the customer's applications or products, or the application or use by customer's third party customer(s). Customer is responsible for doing all necessary testing for the customer's applications and products using NXP Semiconductors products in order to avoid a default of the applications and the products or of the application or use by customer's third party customer(s). NXP does not accept any liability in this respect.

Limiting values — Stress above one or more limiting values (as defined in the Absolute Maximum Ratings System of IEC 60134) will cause permanent damage to the device. Limiting values are stress ratings only and (proper) operation of the device at these or any other conditions above those given in the Recommended operating conditions section (if present) or the Characteristics sections of this document is not warranted. Constant or repeated exposure to limiting values will permanently and irreversibly affect the quality and reliability of the device.

Terms and conditions of commercial sale — NXP Semiconductors products are sold subject to the general terms and conditions of commercial sale, as published at <http://www.nxp.com/profile/terms>, unless otherwise agreed in a valid written individual agreement. In case an individual

agreement is concluded only the terms and conditions of the respective agreement shall apply. NXP Semiconductors hereby expressly objects to applying the customer's general terms and conditions with regard to the purchase of NXP Semiconductors products by customer.

No offer to sell or license — Nothing in this document may be interpreted or construed as an offer to sell products that is open for acceptance or the grant, conveyance or implication of any license under any copyrights, patents or other industrial or intellectual property rights.

Export control — This document as well as the item(s) described herein may be subject to export control regulations. Export might require a prior authorization from national authorities.

10. Contact information

For more information, please visit: <http://www.nxp.com>

For sales office addresses, please send an email to: salesaddresses@nxp.com

9.4 Trademarks

Notice: All referenced brands, product names, service names and trademarks are the property of their respective owners.

Adelante, Bitport, Bitsound, CoolFlux, CoReUse, DESFire, EZ-HV, FabKey, GreenChip, HiPerSmart, HITAG, I²C-bus logo, ICODE, I-CODE, ITEC, Labelution, MIFARE, MIFARE Plus, MIFARE Ultralight, MoReUse, QLPAK, Silicon Tuner, SiliconMAX, SmartXA, STARplug, TOPFET, TrenchMOS, TriMedia and UCODE — are trademarks of NXP B.V.

HD Radio and HD Radio logo — are trademarks of iBiquity Digital Corporation.

11. Contents

1	Product profile	1
1.1	General description	1
1.2	Features and benefits	1
1.3	Applications	1
1.4	Quick reference data	1
2	Pinning information	2
3	Ordering information	2
4	Limiting values	3
5	Thermal characteristics	5
6	Characteristics	6
7	Package outline	10
8	Revision history	11
9	Legal information	12
9.1	Data sheet status	12
9.2	Definitions	12
9.3	Disclaimers	12
9.4	Trademarks	13
10	Contact information	13

Please be aware that important notices concerning this document and the product(s) described herein, have been included in section 'Legal information'.

© NXP B.V. 2010.

All rights reserved.

For more information, please visit: <http://www.nxp.com>

For sales office addresses, please send an email to: salesaddresses@nxp.com

Date of release: 16 November 2010

Document identifier: BUK663R5-30C