



N-Channel 30 V (D-S) MOSFETs

PRODUCT SUMMARY				
	V _{DS} (V)	R _{DS(on)} (Ω)	I _D (A)	Q _g (Typ.)
Channel-1 and Channel-2	30	0.0120 at V _{GS} = 10 V	16 ^a	6.8 nC
		0.0145 at V _{GS} = 4.5 V	16 ^a	

FEATURES

- Halogen-free According to IEC 61249-2-21 Definition
- TrenchFET® Power MOSFETs
- 100 % R_g and UIS Tested
- Compliant to RoHS Directive 2002/95/EC



RoHS
COMPLIANT
HALOGEN
FREE

APPLICATIONS

- Notebook System Power
- POL
- Low Current DC/DC

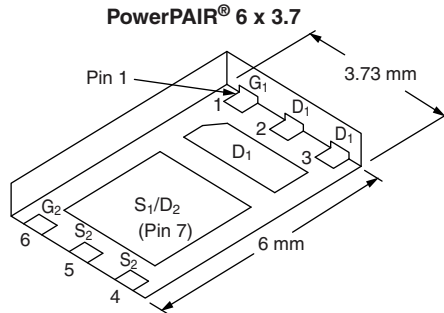

Ordering Information:
SiZ702DT-T1-GE3 (Lead (Pb)-free and Halogen-free)

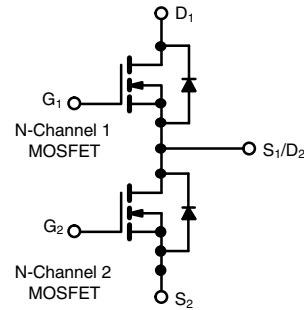

ABSOLUTE MAXIMUM RATINGS (T _A = 25 °C, unless otherwise noted)				
Parameter	Symbol	Channel-1	Channel-2	Unit
Drain-Source Voltage	V _{DS}	30		V
Gate-Source Voltage	V _{GS}	± 20		
Continuous Drain Current (T _J = 150 °C)	I _D	16 ^a		A
		16 ^a		
		13.8 ^{b, c}	14 ^{b, c}	
		11 ^{b, c}	11.2 ^{b, c}	
Pulsed Drain Current	I _{DM}	50		A
Source Drain Current Diode Current	I _S	16 ^a	16 ^a	
		3.2 ^{b, c}	3.7 ^{b, c}	
Single Pulse Avalanche Current	L = 0.1 mH	18		mJ
Single Pulse Avalanche Energy	E _{AS}	16		
Maximum Power Dissipation	P _D	27	30	W
		17.4	19	
		3.9 ^{b, c}	4.5 ^{b, c}	
		2.5 ^{b, c}	2.9 ^{b, c}	
Operating Junction and Storage Temperature Range	T _J , T _{stg}	- 55 to 150		°C
Soldering Recommendations (Peak Temperature) ^{d, e}		260		

THERMAL RESISTANCE RATINGS							
Parameter	Symbol	Channel-1		Channel-2		Unit	
		Typ.	Max.	Typ.	Max.		
Maximum Junction-to-Ambient ^{b, 1}	t ≤ 10 s	R _{thJA}	24	32	21	28	°C/W
Maximum Junction-to-Case (Drain)	Steady State	R _{thJC}	3.5	4.6	3.2	4.2	

Notes:

- Package limited.
- Surface mounted on 1" x 1" FR4 board.
- t = 10 s.
- See solder profile (www.vishay.com/doc?73257). The PowerPAIR is a leadless package. The end of the lead terminal is exposed copper (not plated) as a result of the singulation process in manufacturing. A solder fillet at the exposed copper tip cannot be guaranteed and is not required to ensure adequate bottom side solder interconnection.
- Rework conditions: manual soldering with a soldering iron is not recommended for leadless components.
- Maximum under steady state conditions is 67 °C/W for channel-1 and for channel-2.

SPECIFICATIONS ($T_J = 25\text{ }^\circ\text{C}$, unless otherwise noted)							
Parameter	Symbol	Test Conditions	Min.	Typ.	Max.	Unit	
Static							
Drain-Source Breakdown Voltage	V_{DS}	$V_{GS} = 0\text{ V}$, $I_D = 250\text{ }\mu\text{A}$	Ch-1 Ch-2	30		V	
V_{DS} Temperature Coefficient	$\Delta V_{DS}/T_J$	$I_D = 250\text{ }\mu\text{A}$	Ch-1 Ch-2		33	mV/ $^\circ\text{C}$	
$V_{GS(th)}$ Temperature Coefficient	$\Delta V_{GS(th)}/T_J$	$I_D = 250\text{ }\mu\text{A}$	Ch-1 Ch-2		-5		
Gate Threshold Voltage	$V_{GS(th)}$	$V_{DS} = V_{GS}$, $I_D = 250\text{ }\mu\text{A}$	Ch-1 Ch-2	1		2.5	V
Gate-Body Leakage	I_{GSS}	$V_{DS} = 0\text{ V}$, $V_{GS} = \pm 20\text{ V}$	Ch-1 Ch-2			± 100	nA
Zero Gate Voltage Drain Current	I_{DSS}	$V_{DS} = 30\text{ V}$, $V_{GS} = 0\text{ V}$	Ch-1 Ch-2			1	μA
		$V_{DS} = 30\text{ V}$, $V_{GS} = 0\text{ V}$, $T_J = 55\text{ }^\circ\text{C}$	Ch-1 Ch-2			5	
On-State Drain Current ^b	$I_{D(on)}$	$V_{DS} \geq 5\text{ V}$, $V_{GS} = 10\text{ V}$	Ch-1 Ch-2	20			A
Drain-Source On-State Resistance ^b	$R_{DS(on)}$	$V_{GS} = 10\text{ V}$, $I_D = 13.8\text{ A}$	Ch-1 Ch-2		0.010	0.012	Ω
		$V_{GS} = 4.5\text{ V}$, $I_D = 12.6\text{ A}$	Ch-1 Ch-2		0.012	0.0145	
Forward Transconductance ^b	g_{fs}	$V_{DS} = 10\text{ V}$, $I_D = 13.8\text{ A}$	Ch-1 Ch-2		47		S
Dynamic^a							
Input Capacitance	C_{iss}	$V_{DS} = 15\text{ V}$, $V_{GS} = 0\text{ V}$, $f = 1\text{ MHz}$	Ch-1 Ch-2		790		pF
Output Capacitance	C_{oss}		Ch-1 Ch-2		190		
Reverse Transfer Capacitance	C_{rss}		Ch-1 Ch-2		76		
Total Gate Charge	Q_g	$V_{DS} = 15\text{ V}$, $V_{GS} = 10\text{ V}$, $I_D = 13.8\text{ A}$	Ch-1 Ch-2		14	21	nC
			Ch-1 Ch-2		6.8	11	
Gate-Source Charge	Q_{gs}	$V_{DS} = 15\text{ V}$, $V_{GS} = 4.5\text{ V}$, $I_D = 13.8\text{ A}$	Ch-1 Ch-2		2.6		
Gate-Drain Charge	Q_{gd}		Ch-1 Ch-2		1.9		
Gate Resistance	R_g	$f = 1\text{ MHz}$	Ch-1 Ch-2	0.4	2	4	Ω

Notes:

- a. Guaranteed by design, not subject to production testing.
 b. Pulse test; pulse width $\leq 300\text{ }\mu\text{s}$, duty cycle $\leq 2\%$.



SPECIFICATIONS ($T_J = 25\text{ }^\circ\text{C}$, unless otherwise noted)							
Parameter	Symbol	Test Conditions	Min.	Typ.	Max.	Unit	
Dynamic^a							
Turn-On Delay Time	$t_{d(on)}$	$V_{DD} = 15\text{ V}, R_L = 1.5\ \Omega$ $I_D \cong 10\text{ A}, V_{GEN} = 4.5\text{ V}, R_g = 1\ \Omega$	Ch-1		15	25	ns
Rise Time	t_r		Ch-2		12	20	
Turn-Off Delay Time	$t_{d(off)}$		Ch-1		20	30	
Fall Time	t_f		Ch-2		10	15	
Turn-On Delay Time	$t_{d(on)}$	$V_{DD} = 15\text{ V}, R_L = 1.5\ \Omega$ $I_D \cong 10\text{ A}, V_{GEN} = 10\text{ V}, R_g = 1\ \Omega$	Ch-1		10	15	
Rise Time	t_r		Ch-2		12	20	
Turn-Off Delay Time	$t_{d(off)}$		Ch-1		20	30	
Fall Time	t_f		Ch-2		10	15	
Drain-Source Body Diode Characteristics							
Continuous Source-Drain Diode Current	I_S	$T_C = 25\text{ }^\circ\text{C}$	Ch-1			16	A
Pulse Diode Forward Current ^a	I_{SM}		Ch-2			50	
Body Diode Voltage	V_{SD}	$I_S = 10\text{ A}, V_{GS} = 0\text{ V}$	Ch-1		0.8	1.2	V
Body Diode Reverse Recovery Time	t_{rr}	$I_F = 10\text{ A}, di/dt = 100\text{ A}/\mu\text{s}, T_J = 25\text{ }^\circ\text{C}$	Ch-1		20	40	ns
Body Diode Reverse Recovery Charge	Q_{rr}		Ch-2		10	20	nC
Reverse Recovery Fall Time	t_a		Ch-1		11		ns
Reverse Recovery Rise Time	t_b		Ch-2		9		

Notes:

- a. Guaranteed by design, not subject to production testing.
 b. Pulse test; pulse width $\leq 300\ \mu\text{s}$, duty cycle $\leq 2\%$.

Stresses beyond those listed under "Absolute Maximum Ratings" may cause permanent damage to the device. These are stress ratings only, and functional operation of the device at these or any other conditions beyond those indicated in the operational sections of the specifications is not implied. Exposure to absolute maximum rating conditions for extended periods may affect device reliability.

SiZ702DT

Vishay Siliconix



CHANNEL-1 TYPICAL CHARACTERISTICS (25 °C, unless otherwise noted)

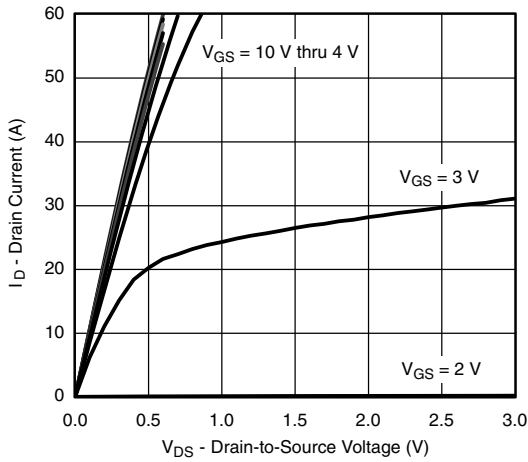

Output Characteristics

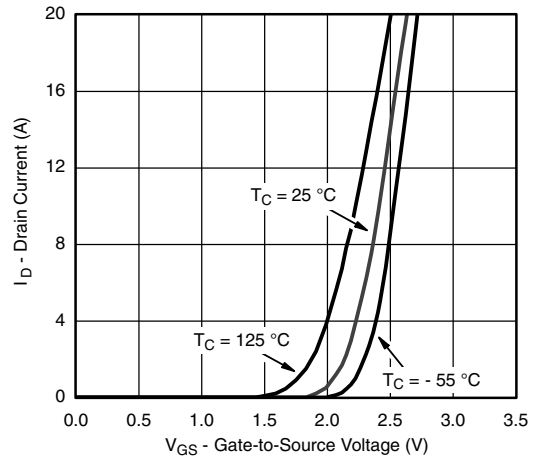

Transfer Characteristics

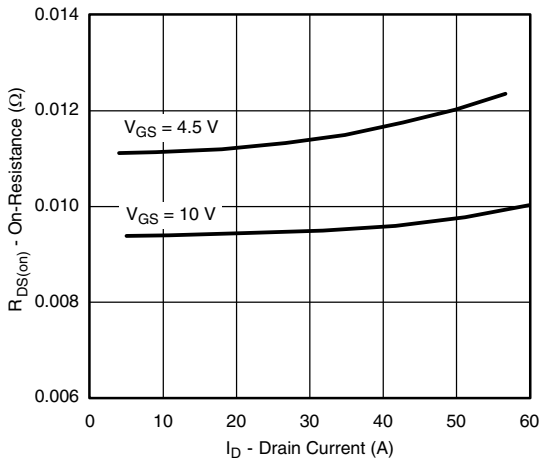

On-Resistance vs. Drain Current

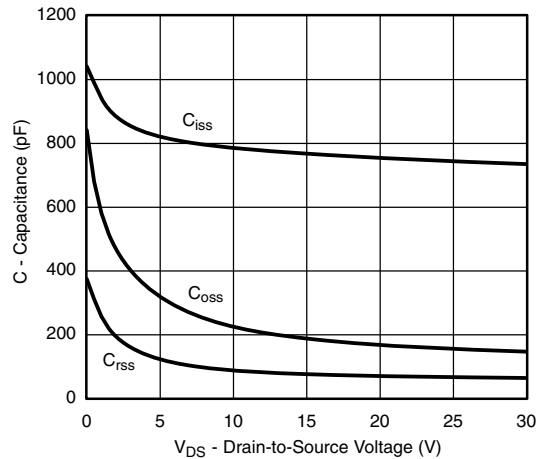

Capacitance

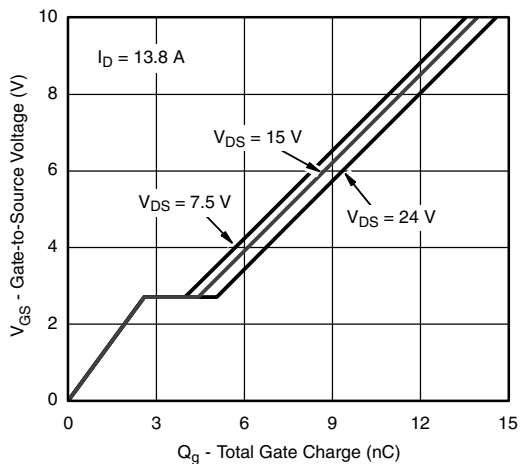

Gate Charge

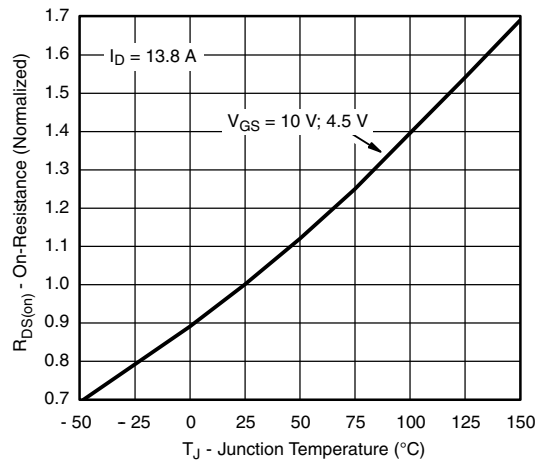

On-Resistance vs. Junction Temperature



CHANNEL-1 TYPICAL CHARACTERISTICS (25 °C, unless otherwise noted)

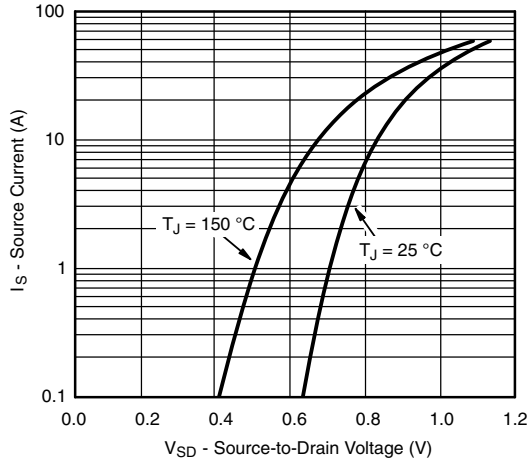

Source-Drain Diode Forward Voltage

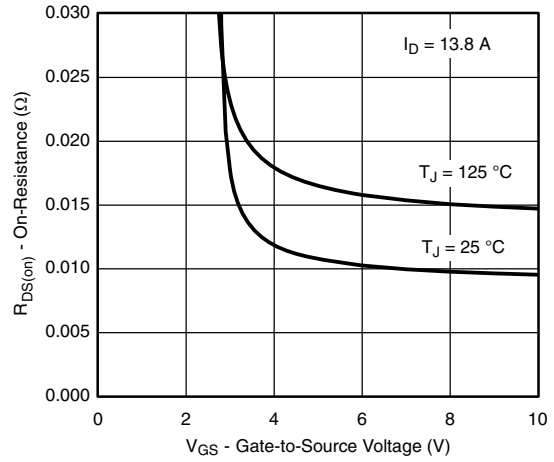

On-Resistance vs. Gate-to-Source Voltage

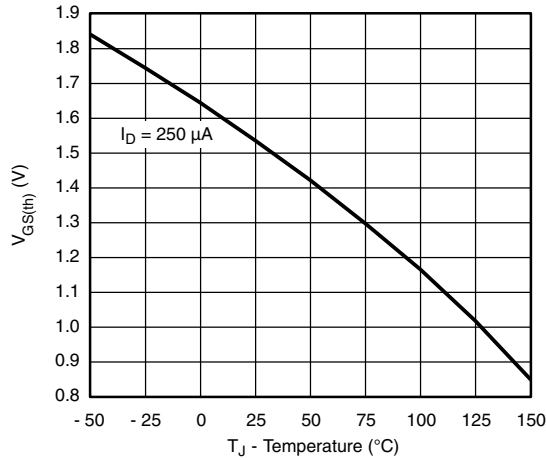

Threshold Voltage

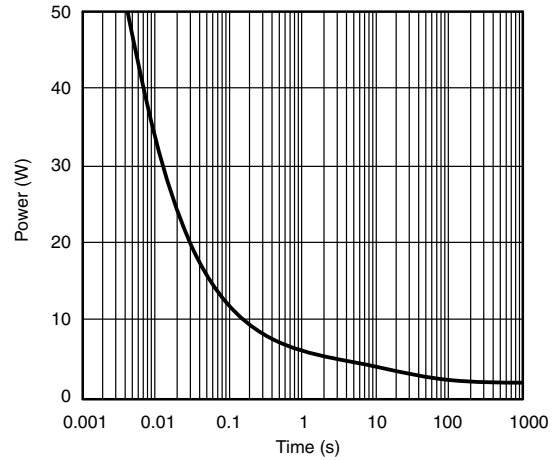

Single Pulse Power

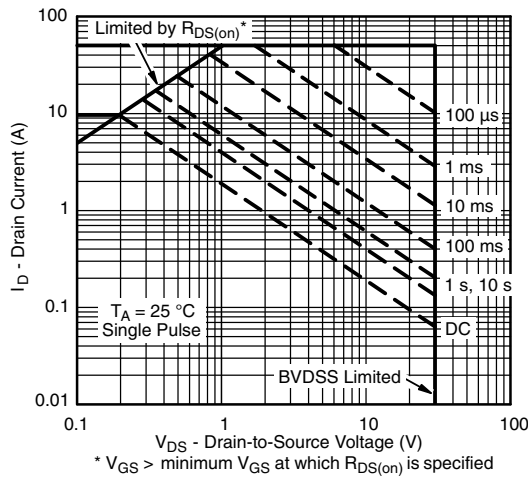

Safe Operating Area, Junction-to-Ambient

CHANNEL-1 TYPICAL CHARACTERISTICS (25 °C, unless otherwise noted)

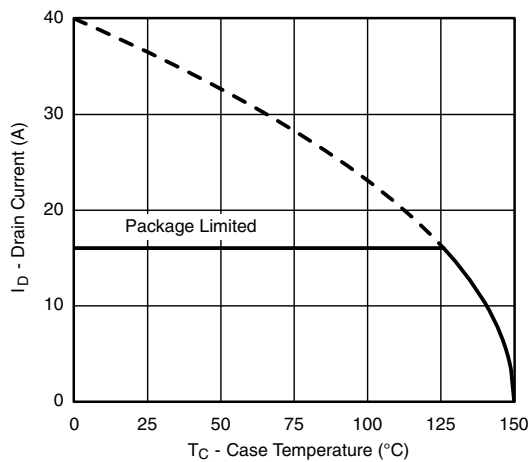

Current Derating*

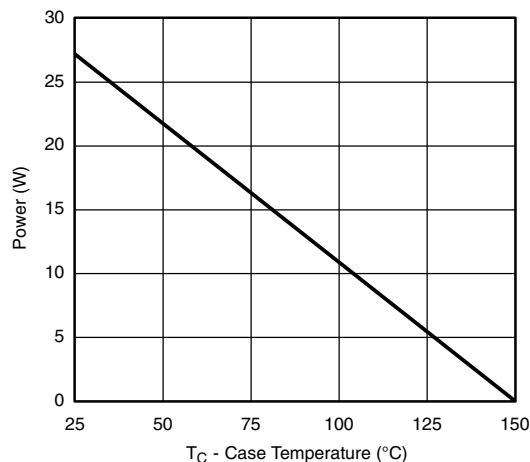

Power, Junction-to-Case

* The power dissipation P_D is based on $T_{J(max)} = 150$ °C, using junction-to-case thermal resistance, and is more useful in settling the upper dissipation limit for cases where additional heatsinking is used. It is used to determine the current rating, when this rating falls below the package limit.



CHANNEL-1 TYPICAL CHARACTERISTICS (25 °C, unless otherwise noted)

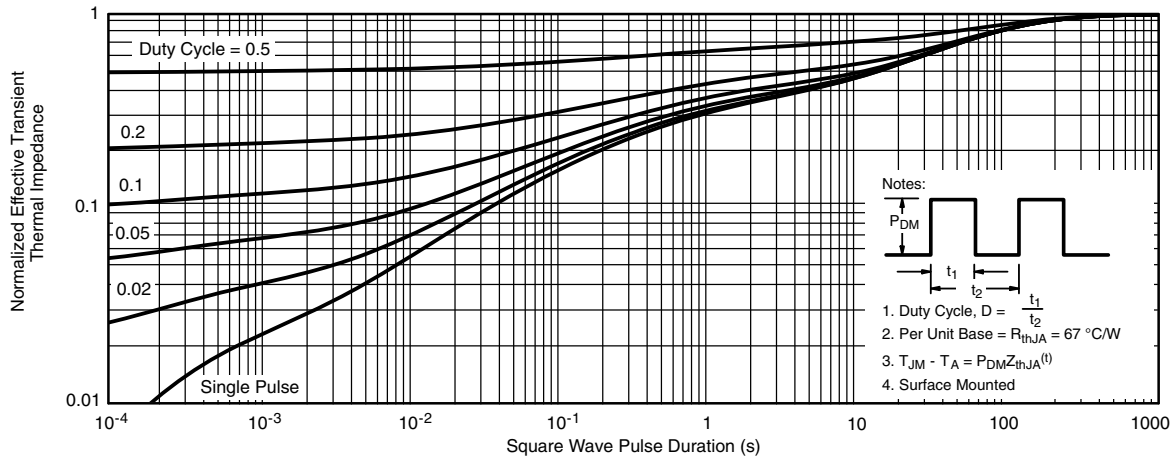

Normalized Thermal Transient Impedance, Junction-to-Ambient

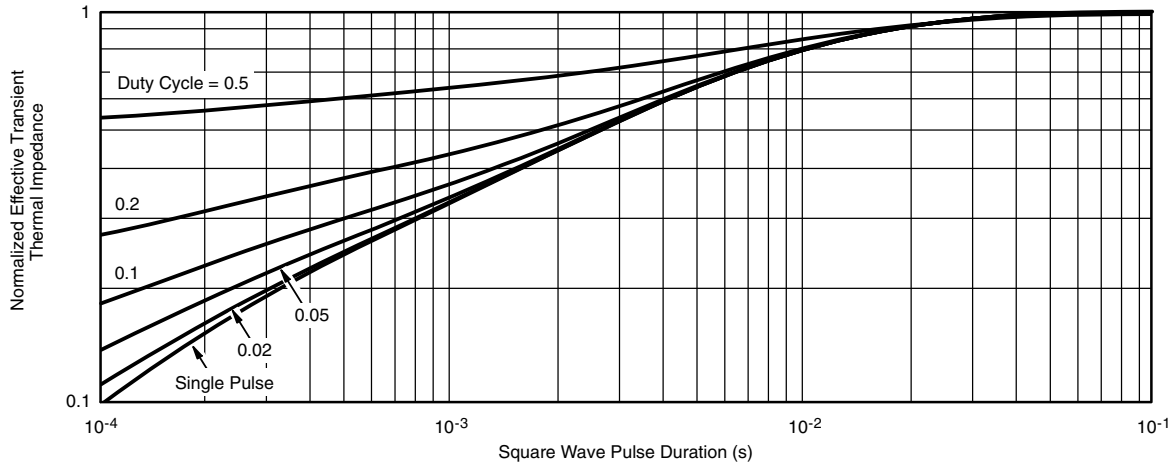

Normalized Thermal Transient Impedance, Junction-to-Case

Si702DT

Vishay Siliconix



CHANNEL-2 TYPICAL CHARACTERISTICS (25 °C, unless otherwise noted)

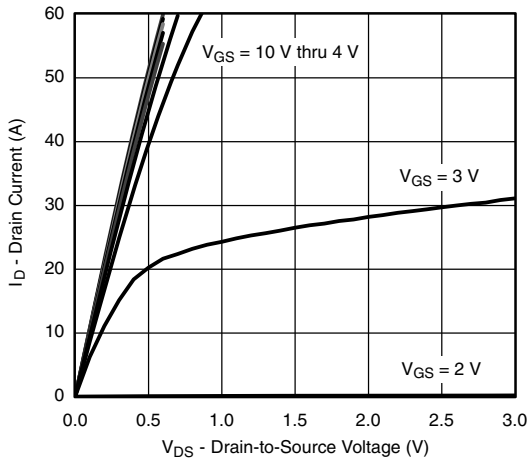

Output Characteristics

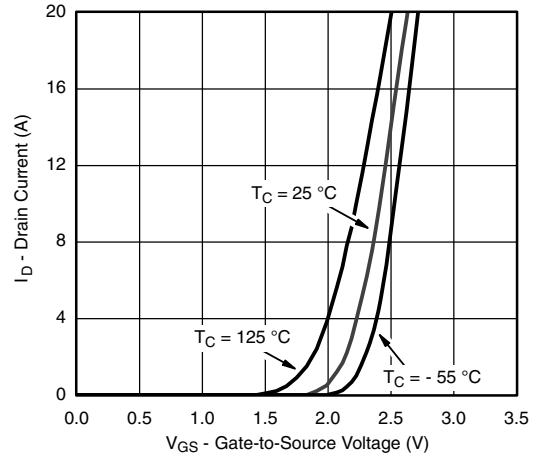

Transfer Characteristics

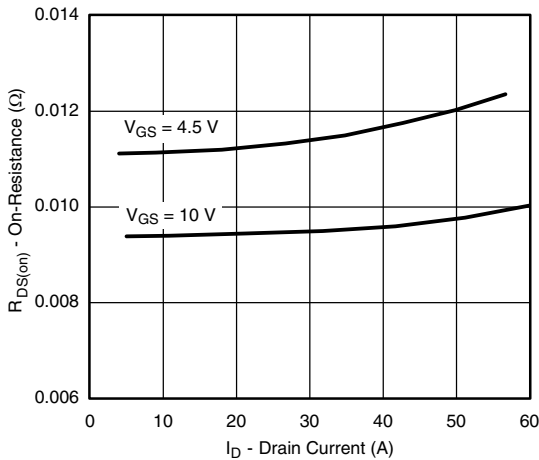

On-Resistance vs. Drain Current

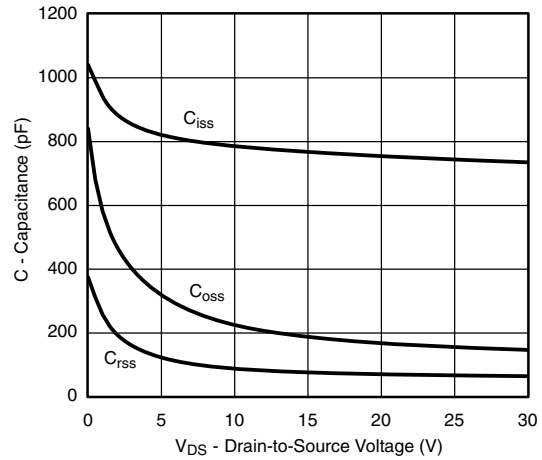

Capacitance

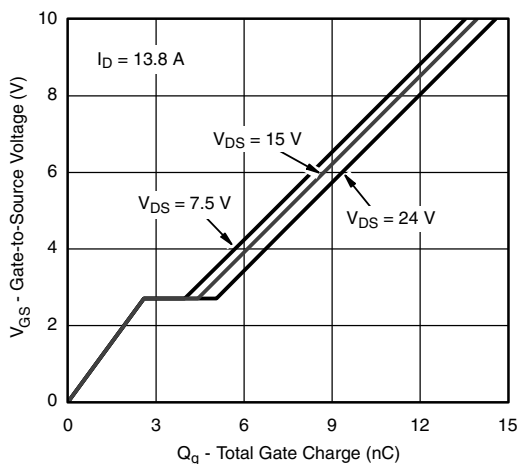

Gate Charge

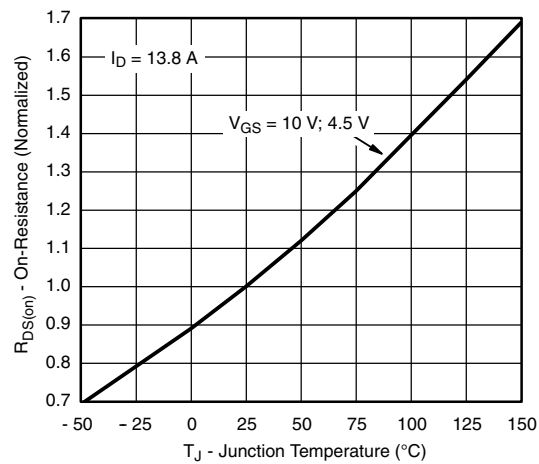

On-Resistance vs. Junction Temperature



CHANNEL-2 TYPICAL CHARACTERISTICS (25 °C, unless otherwise noted)

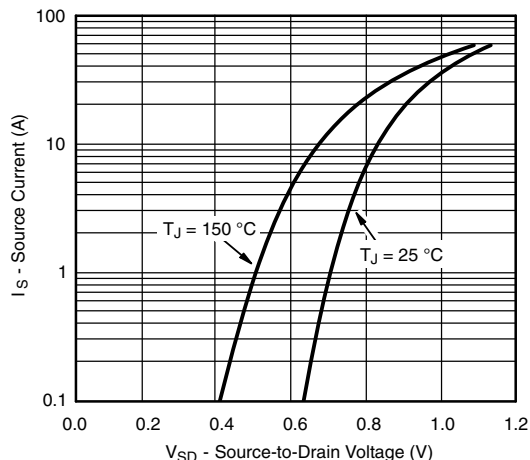

Source-Drain Diode Forward Voltage

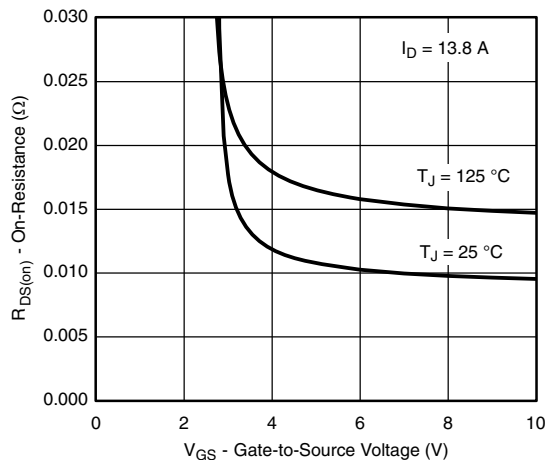

On-Resistance vs. Gate-to-Source Voltage

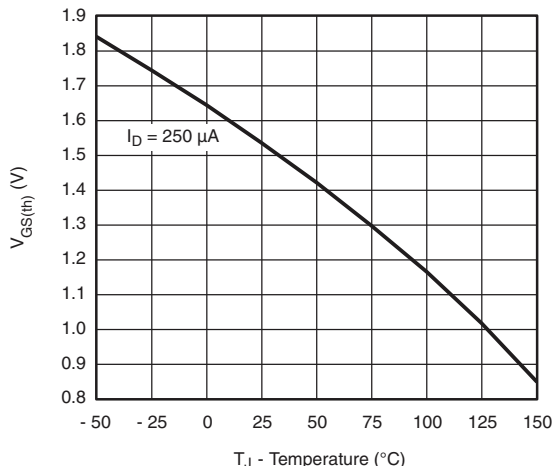

Threshold Voltage

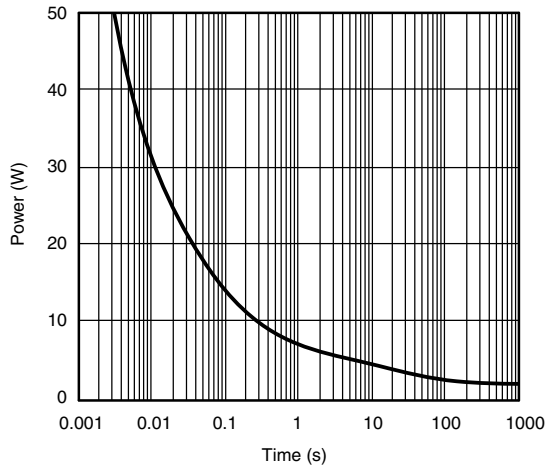

Single Pulse Power

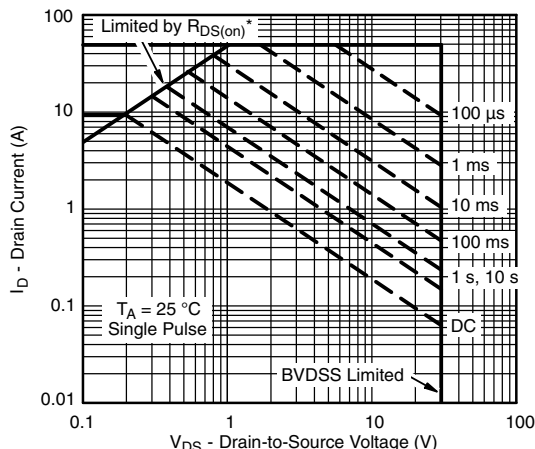

Safe Operating Area, Junction-to-Ambient

SiZ702DT

Vishay Siliconix



CHANNEL-2 TYPICAL CHARACTERISTICS (25 °C, unless otherwise noted)

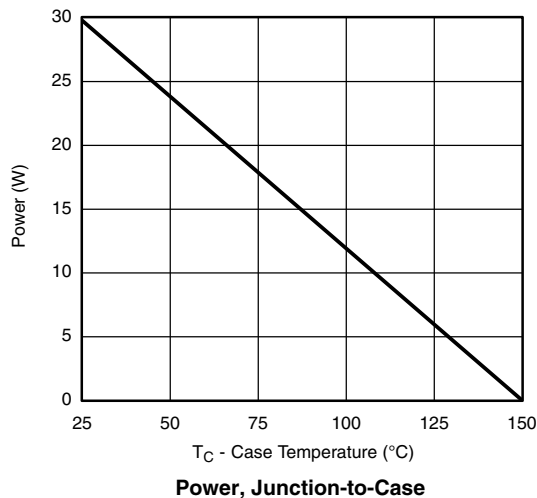
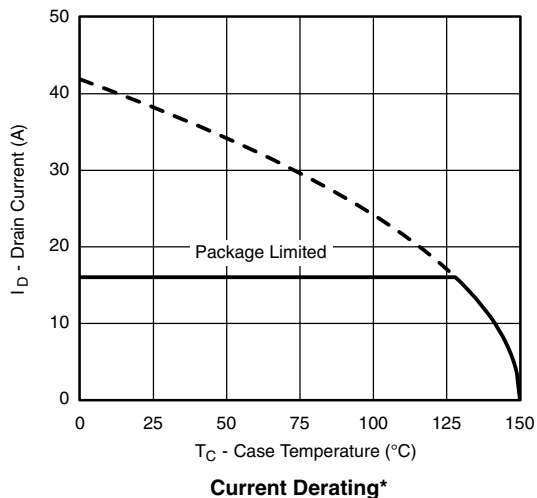

* The power dissipation P_D is based on $T_{J(max)} = 150$ °C, using junction-to-case thermal resistance, and is more useful in settling the upper dissipation limit for cases where additional heatsinking is used. It is used to determine the current rating, when this rating falls below the package limit.



CHANNEL-2 TYPICAL CHARACTERISTICS (25 °C, unless otherwise noted)

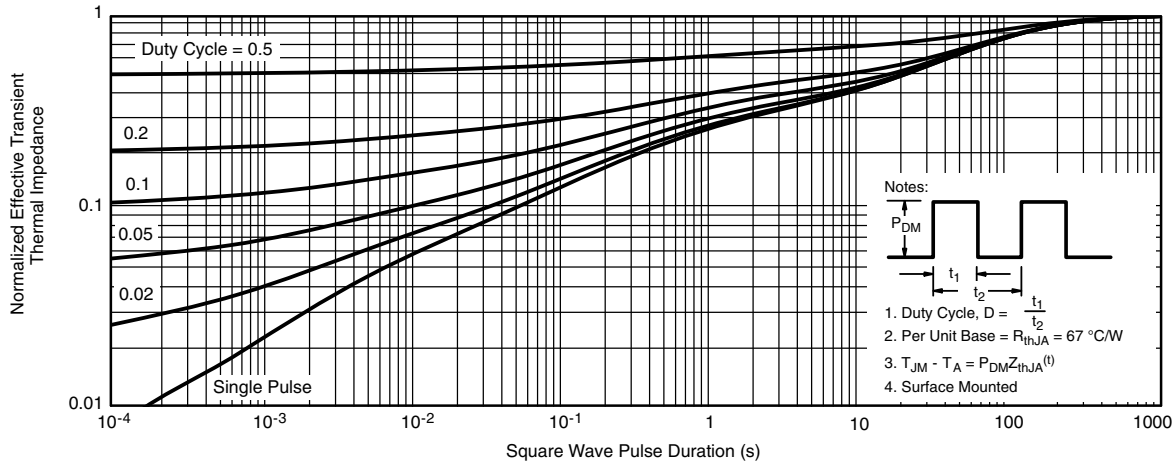

Normalized Thermal Transient Impedance, Junction-to-Ambient

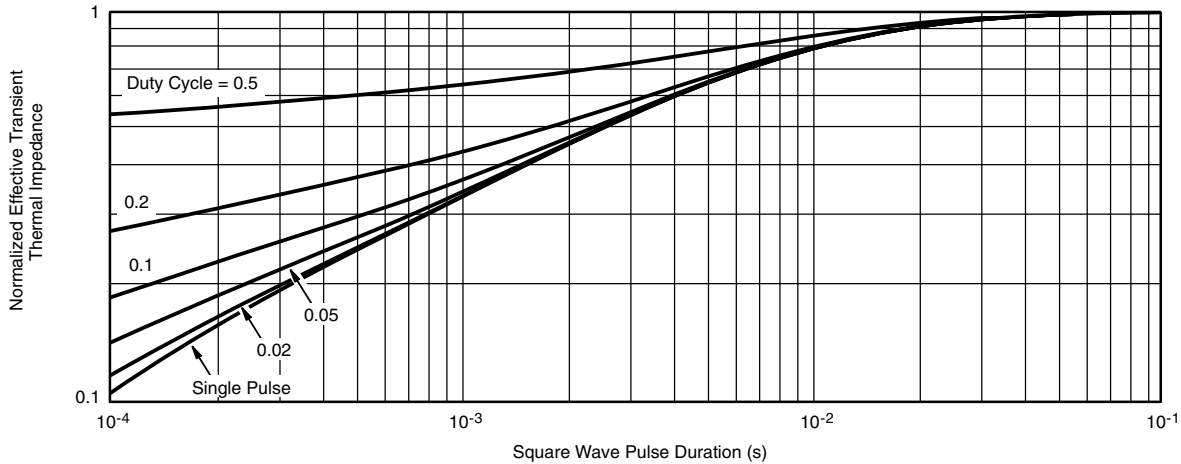

Normalized Thermal Transient Impedance, Junction-to-Case

Vishay Siliconix maintains worldwide manufacturing capability. Products may be manufactured at one of several qualified locations. Reliability data for Silicon Technology and Package Reliability represent a composite of all qualified locations. For related documents such as package/tape drawings, part marking, and reliability data, see www.vishay.com/ppg?65525.

PowerPAIR™ 6 x 3.7 CASE OUTLINE

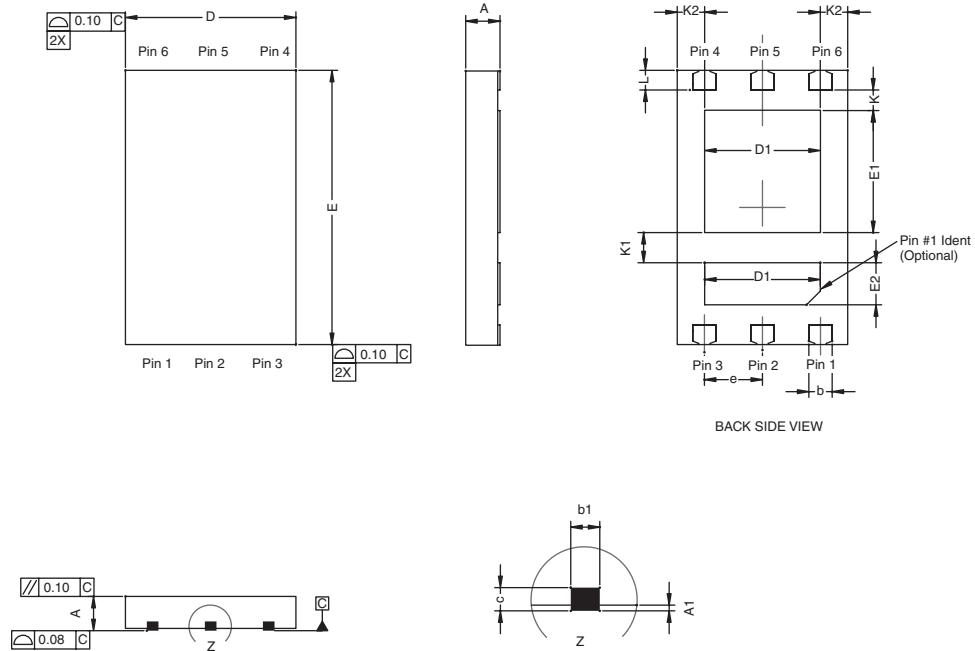

DIM.	MILLIMETERS			INCHES		
	MIN.	NOM.	MAX.	MIN.	NOM.	MAX.
A	0.70	0.75	0.80	0.028	0.030	0.032
A1	0.00	-	0.05	0.000	-	0.002
b	0.46	0.51	0.56	0.018	0.020	0.022
b1	0.20	0.25	0.38	0.008	0.010	0.015
C	0.18	0.20	0.23	0.007	0.008	0.009
D	3.65	3.73	3.81	0.144	0.147	0.150
D1	2.41	2.53	2.65	0.095	0.100	0.104
E	5.92	6.00	6.08	0.233	0.236	0.239
E1	2.62	2.67	2.72	0.103	0.105	0.107
E2	0.87	0.92	0.97	0.034	0.036	0.038
e	1.27 BSC			0.05 BSC		
K	0.45 TYP.			0.018 TYP.		
K1	0.66 TYP.			0.026 TYP.		
K2	0.60 TYP.			0.024 TYP.		
L	0.38	0.43	0.48	0.015	0.017	0.019
ECN: S-82772-Rev. B, 17-Nov-08 DWG: 5979						

RECOMMENDED PAD FOR PowerPAIR™ 6 x 3.7



Recommended PAD for PowerPAIR 6 x 3.7
 Dimensions in inches (mm)
 Keep-out 0.3520 (8.94) x 0.4390 (11.151)



Disclaimer

ALL PRODUCT, PRODUCT SPECIFICATIONS AND DATA ARE SUBJECT TO CHANGE WITHOUT NOTICE TO IMPROVE RELIABILITY, FUNCTION OR DESIGN OR OTHERWISE.

Vishay Intertechnology, Inc., its affiliates, agents, and employees, and all persons acting on its or their behalf (collectively, "Vishay"), disclaim any and all liability for any errors, inaccuracies or incompleteness contained in any datasheet or in any other disclosure relating to any product.

Vishay makes no warranty, representation or guarantee regarding the suitability of the products for any particular purpose or the continuing production of any product. To the maximum extent permitted by applicable law, Vishay disclaims (i) any and all liability arising out of the application or use of any product, (ii) any and all liability, including without limitation special, consequential or incidental damages, and (iii) any and all implied warranties, including warranties of fitness for particular purpose, non-infringement and merchantability.

Statements regarding the suitability of products for certain types of applications are based on Vishay's knowledge of typical requirements that are often placed on Vishay products in generic applications. Such statements are not binding statements about the suitability of products for a particular application. It is the customer's responsibility to validate that a particular product with the properties described in the product specification is suitable for use in a particular application. Parameters provided in datasheets and / or specifications may vary in different applications and performance may vary over time. All operating parameters, including typical parameters, must be validated for each customer application by the customer's technical experts. Product specifications do not expand or otherwise modify Vishay's terms and conditions of purchase, including but not limited to the warranty expressed therein.

Except as expressly indicated in writing, Vishay products are not designed for use in medical, life-saving, or life-sustaining applications or for any other application in which the failure of the Vishay product could result in personal injury or death. Customers using or selling Vishay products not expressly indicated for use in such applications do so at their own risk. Please contact authorized Vishay personnel to obtain written terms and conditions regarding products designed for such applications.

No license, express or implied, by estoppel or otherwise, to any intellectual property rights is granted by this document or by any conduct of Vishay. Product names and markings noted herein may be trademarks of their respective owners.