

ISL85403DEMO1Z Demonstration Board User Guide

Description

The ISL85403DEMO1Z board allows quick evaluation of the ISL85403 in the synchronous buck configuration. It also demonstrates the compact size solution for the wide input voltage range point-of-load DC/DC converter using ISL85403.

Specifications

The design specifications of the ISL85403DEMO1Z are shown in [Table 1](#).

TABLE 1. SPECIFICATIONS

PARAMETERS	VALUES
Input Voltage (V_{IN})	7V to 40V
Output Voltage (V_{OUT})	5.0V
Max. Output Current (IOUT_MAX)	2.5A
Switching Frequency	500kHz
Output Ripple	50mV at 2.5A Load
Peak Efficiency	93% at 50% Load, 12V Input

Key Features

- Small, compact design
- V_{IN} range of 7V to 40V
- V_{OUT} adjustable from 0.8V to 5V
- Convenient power connection

References

[ISL85403 Datasheet](#)

Ordering Information

PART NUMBER	DESCRIPTION
ISL85403DEMO1Z	ISL85403 Evaluation kit, synchronous buck configuration 5V output

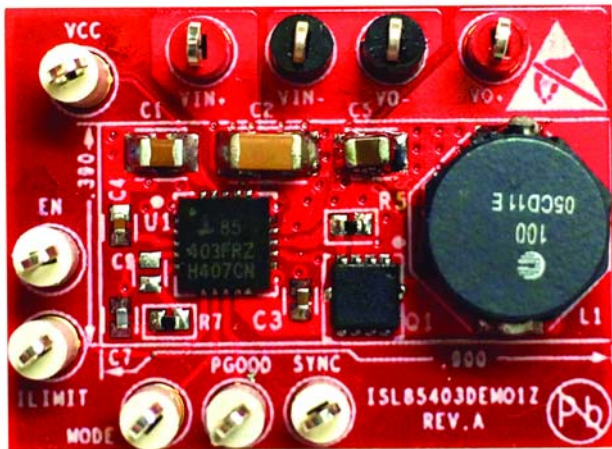

FIGURE 1. TOP VIEW

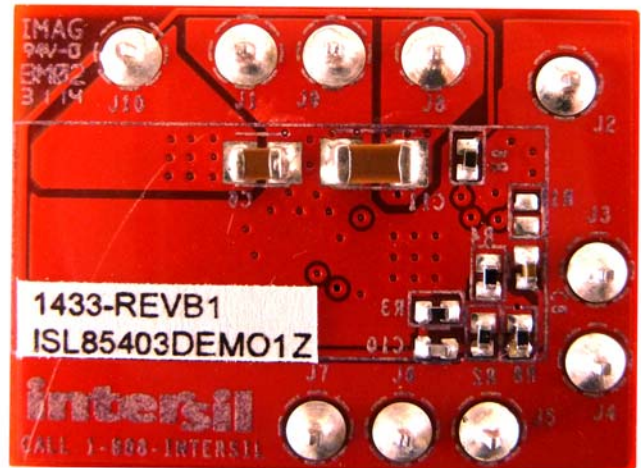

FIGURE 2. BOTTOM VIEW

Functional Description

The ISL85403 is a flexible switching regulator with an integrated 127mΩ high-side MOSFET. It can be used as a synchronous buck converter, a 2-stage boost-buck converter, or a noninverting buck-boost converter.

The ISL85403DEMO1Z board demonstrates the compact size and operations of the ISL85403 in the synchronous buck configuration. The ISL85403DEMO1Z board is shown in [Figures 1](#) and [2](#).

The schematic is shown on [page 3](#), bill of materials on [page 4](#), and PCB layers for reference start on [page 7](#). [Figures 4](#) through [12](#) show performance data taken from the demo board.

Operating Range

The board input voltage range is 7V to 40V. The output voltage is set to 5V and can be changed by voltage feedback resistors R_3 and R_4 , as shown in [Equation 1](#):

$$R_4 = R_3 \cdot \frac{V_{ref}}{V_{out} - V_{ref}} \quad (\text{EQ. 1})$$

NOTE: In order to change to a higher output voltage, the output capacitors have to be changed for the higher voltage rating.

The board is set to a default frequency of 500kHz (FS pin/ R_1 is open). The switching frequency can be programmed to other values by a resistor at R_1 . Refer to the [ISL85403](#) datasheet for the resistor value and the switching frequency. The switching frequency can also be synchronized to external clock by connecting the external clock to the SYNC terminal (J7).

PCB Layout Guidelines

1. Place the input ceramic capacitors as closely as possible to the IC VIN pin and power ground connecting to the power MOSFET or Diode. Keep this loop (input ceramic capacitor, IC VIN pin and MOSFET/Diode) as tiny as possible to minimize the voltage spikes induced by the trace parasitic inductance.
2. Keep the phase node copper area small but large enough to handle the load current.
3. Place the output ceramic and aluminum capacitors close to the power stage components as well.
4. Place vias (at least 9) in the bottom pad of the IC. The bottom pad should be placed in ground copper plane with an area as large as possible in multiple layers to effectively reduce the thermal impedance.
5. Place the 4.7μF ceramic decoupling capacitor at the VCC pin (the closest place to the IC). Put multiple vias close to the ground pad of this capacitor.
6. Keep the bootstrap capacitor close to the IC.
7. Keep the LGATE drive trace as short as possible and try to avoid using via in the LGATE drive path to achieve the lowest impedance.
8. Place the output voltage sense trace close to the place that is to be strictly regulated.
9. Place all the peripheral control components close to the IC.

Quick Test Setup

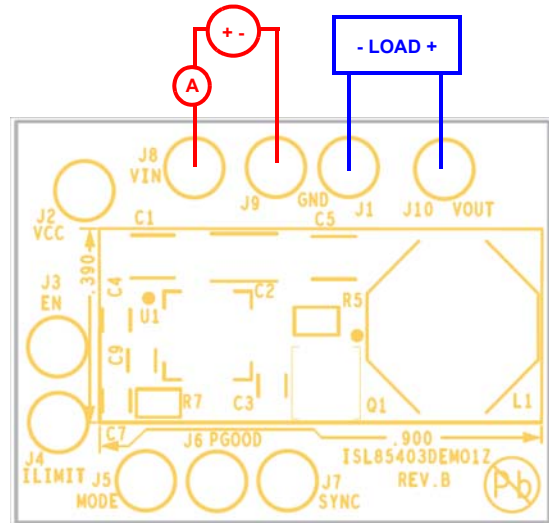
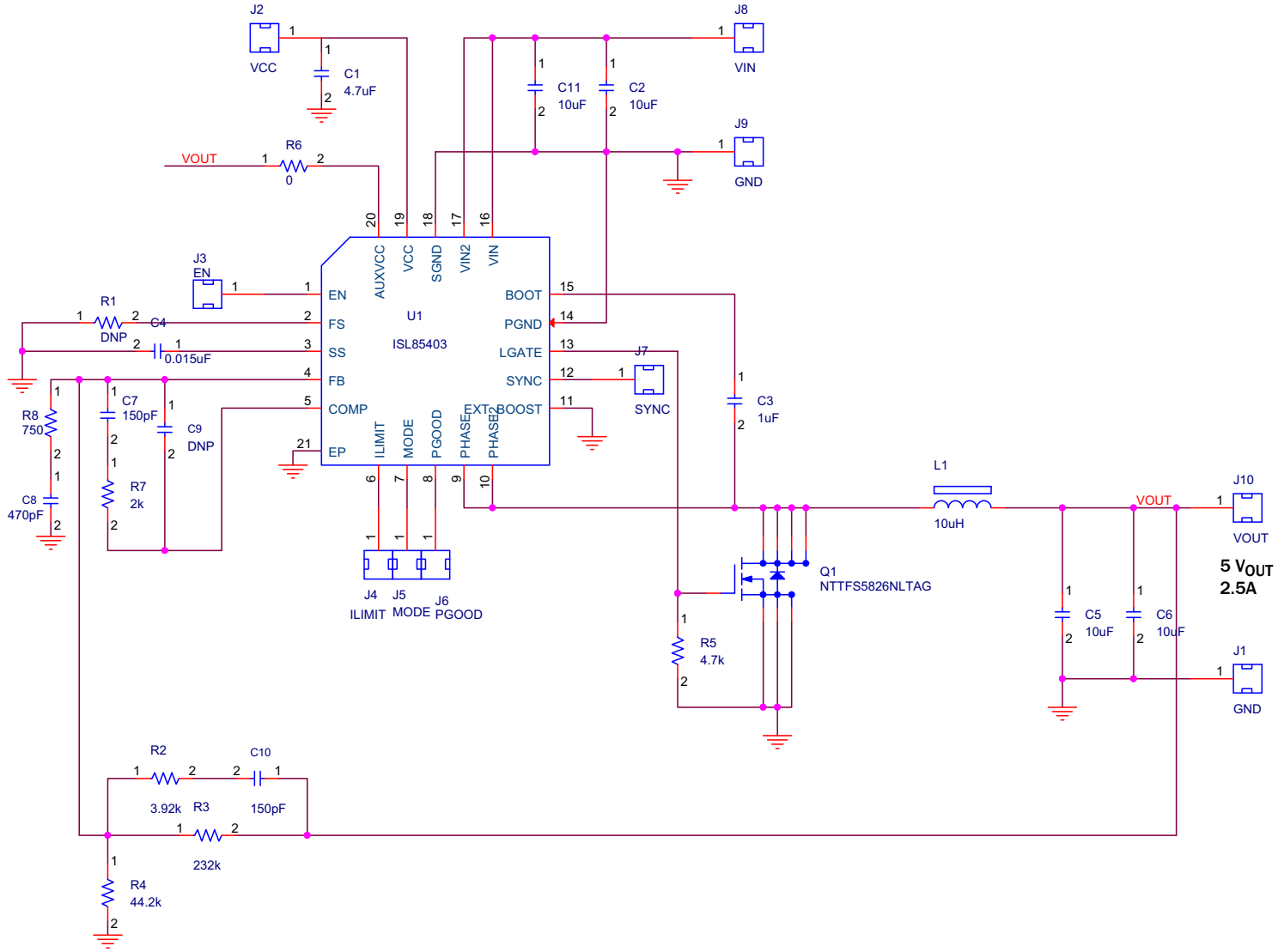

FIGURE 3. ISL85403DEMO1Z BOARD SETUP

1. If PWM mode is desired, connect test point MODE (J5) to ground. Otherwise leave the J5 open for PFM mode.
2. Connect the power supply to the input terminals VIN (J8) and GND (J9). Connect the load terminals to the buck outputs VOUT (J10) and GND (J11). Make sure the setup is correct prior to applying any power or load to the board.
3. Adjust the power supply to 12V and turn it on.
4. Verify the output voltage is 5V and use oscilloscope to monitor the phase node waveforms.

ISL85403DEMO1Z Circuit Schematic



Application Note 1960

Bill of Materials

REF DES	PART NUMBER	QTY	DESCRIPTION	MANUFACTURER
C9		0	DNP	
C7, C10	VARIOUS	2	CAP, SMD, 0402, 150pF, 50V, 10%, COG, ROHS	VARIOUS
C3	ECJ-OEBOJ105M	1	CAP, SMD, 0402, 1µF, 6.3V, 20%, X5R, ROHS	PANASONIC
C4	VARIOUS	1	CAP, SMD, 0402, 0.015µF, 16V, 10%, X7R, ROHS	VARIOUS
C8	VARIOUS	1	CAP, SMD, 0402, 470pF, 50V, 10%, X7R, ROHS	VARIOUS
C5, C6	GRM21BR71A106KE51K	2	CAP, SMD, 0805, 10µF, 10V, 10%, X7R, ROHS	Murata
C1	GRM21BR71A475KA73L	1	CAP, SMD, 0805, 4.7µF, 10V, 10%, X7R, ROHS	Murata
C2, C11	C3216X5R1H106K	2	CAP, SMD, 1206, 10µF, 50V, 10%, X5R, ROHS	TDK
L1	SD8350-100-R	1	COIL-PWR INDUCTOR, SMD, 9.5x8.3, 10µH, 20%, 4A, 31.4mΩ, ROHS	COILTRONICS
U1	ISL85403IRZ	1	IC-SWITCHING REGULATOR, 20P, QFN, 4X4, ROHS	INTERSIL
Q1	NTTFS5826NLTAG	1	TRANSIST-MOS, N-CHANNEL, 8P, PG-TSDSON-8, 60V, 8A, ROHS	ON SEMI
R2	VARIOUS	1	RES, SMD, 0402, 3.92k, 1/16W, 1%, TF, ROHS	VARIOUS
R3	VARIOUS	1	RES, SMD, 0402, 232k, 1/16W, 1%, TF, ROHS	VARIOUS
R7	VARIOUS	1	RES, SMD, 0402, 2k, 1/16W, 1%, TF, ROHS	VARIOUS
R4	ERJ-2RKF4422X	1	RES, SMD, 0402, 44.2k, 1/16W, 1%, TF, ROHS	VARIOUS
R5	VARIOUS	1	RES, SMD, 0402, 4.7k, 1/16W, 1%, TF, ROHS	VARIOUS
R6	VARIOUS	1	RES, SMD, 0402, 0Ω, 1/16W, 1%, TF, ROHS	VARIOUS
R1	N/A	0	Do not populate	N/A

Typical Performance Curves

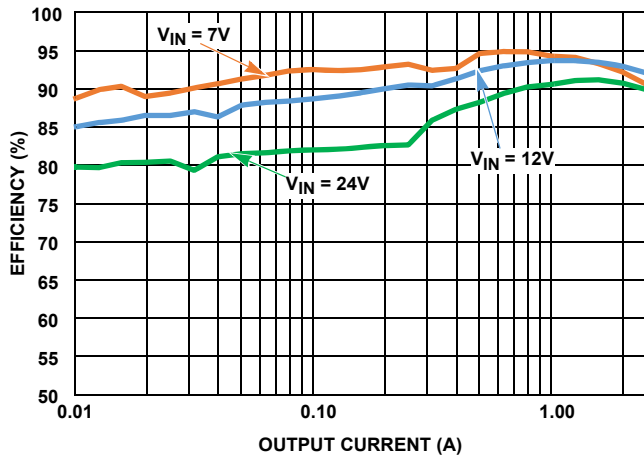

FIGURE 4. EFFICIENCY vs LOAD

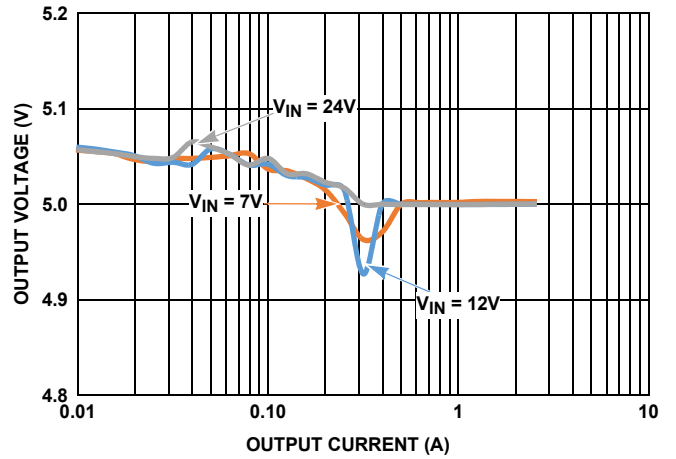

FIGURE 5. LINE REGULATION

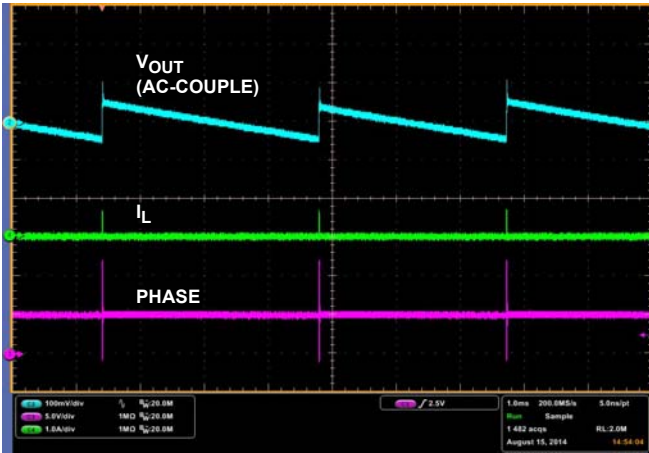

FIGURE 6. OUTPUT RIPPLE AT 0A LOAD

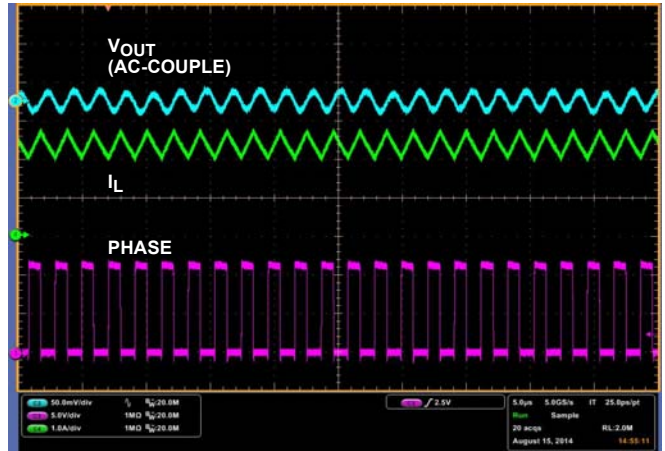

FIGURE 7. OUTPUT RIPPLE AT 2.5A LOAD

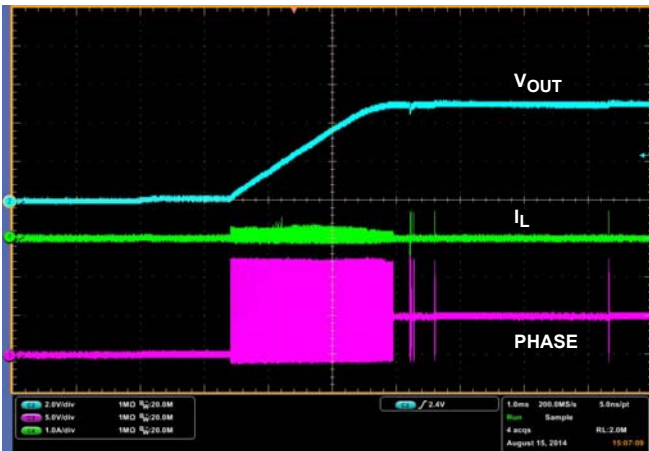

FIGURE 8. SOFT-START AT 0A LOAD

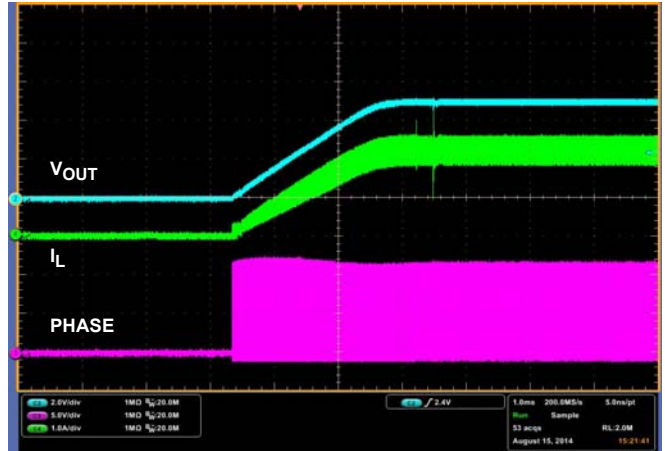

FIGURE 9. SOFT-START AT 2.5A LOAD

Typical Performance Curves (Continued)

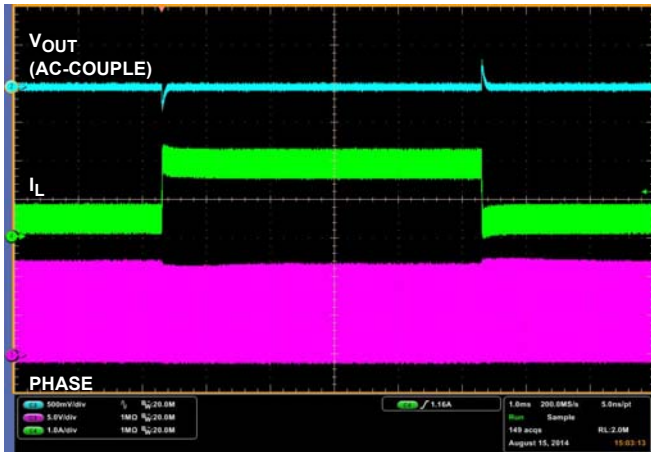

FIGURE 10. LOAD TRANSIENT RESPONSE

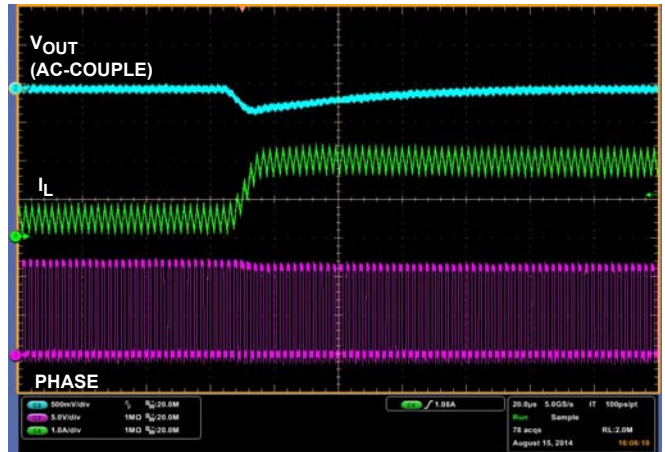

FIGURE 11. LOAD TRANSIENT RESPONSE



FIGURE 12. LOAD TRANSIENT RESPONSE

Board Layout (Continued)

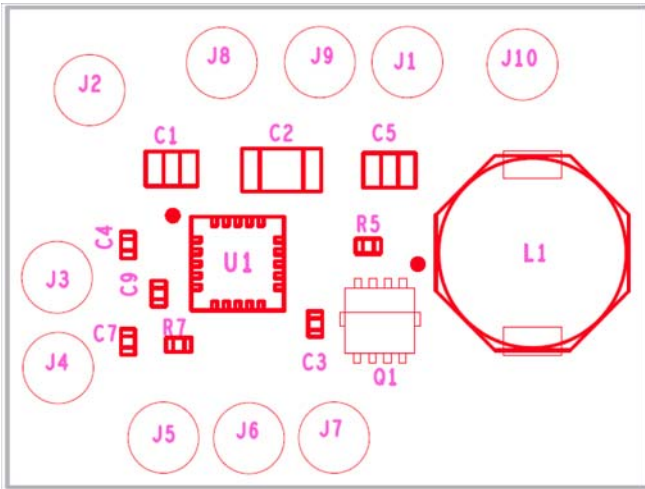

FIGURE 19. TOP COMPONENT ASSEMBLY

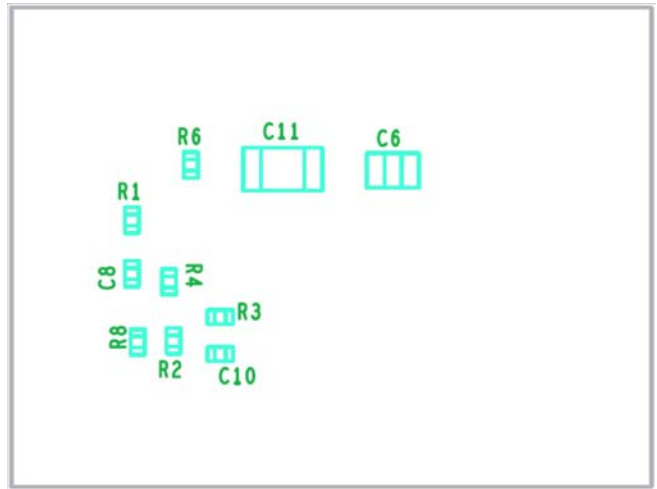

FIGURE 20. BOTTOM COMPONENT ASSEMBLY (MIRRORED)

Intersil Corporation reserves the right to make changes in circuit design, software and/or specifications at any time without notice. Accordingly, the reader is cautioned to verify that the Application Note or Technical Brief is current before proceeding.

For information regarding Intersil Corporation and its products, see www.intersil.com