

ACDBC540-HF

Reverse Voltage: 40 Volts
Forward Current: 5.0 Amp
RoHS Device
Halogen free

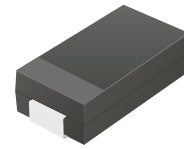

Features

- Low profile package.
- Ideal for automated placement.
- Guard Ring for over voltage protection.
- Low forward voltage drop.
- Comply with AEC-Q101

Mechanical data

- Case: DO-214AB / SMC, molded plastic.
- Epoxy: UL flammability classification rate 94V-0 .
- Terminals: Lead free plating (Tin finish).
Solderable per MIL-STD-202, Method 208.
- Polarity: Indicated by cathode band.
- Weight: 0.231 grams(approx.).

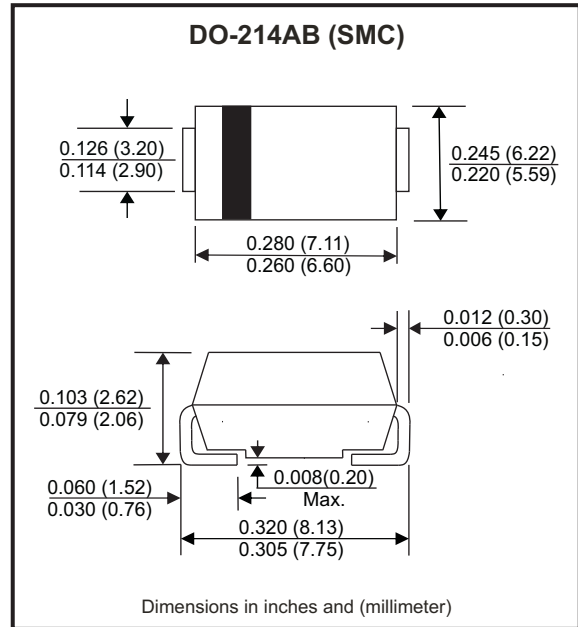

Circuit diagram



Maximum Ratings (at TA=25°C unless otherwise noted)

Parameter	Conditions	Symbol	MIN.	TYP.	MAX.	Unit
Repetitive peak reverse voltage		V_{RRM}			40	V
DC blocking voltage		V_{DC}			40	V
RMS voltage		V_{RMS}			28	V
Average forward rectified current		I_F			5	A
Peak forward surge current	8.3ms single half sine-wave superimposed on rate load (JEDEC method)	I_{FSM}			100	A
Operating Temperature range		T_J	-55		+125	°C
Storage temperature range		T_{STG}	-55		+150	°C

Electrical Characteristics (at TA=25°C unless otherwise noted)

Parameter	Conditions	Symbol	MIN.	TYP.	MAX.	Unit
Instantaneous forward voltage	$I_F = 5A, T_A = 25^\circ C$	V_F			0.55	V
Reverse Current	$V_R = V_{RRM}, T_A = 25^\circ C$	I_R			0.5	mA
	$V_R = V_{RRM}, T_A = 100^\circ C$	I_R			10	mA
Junction capacitance (Note 1)	f=1MHz and applied 4V DC reverse Voltage	C_J		300		pF
Thermal Resistance	Junction to case	$R_{\theta JC}$		25		°C/W

Note: 1. Measured at 1.0MHZ and applied reverse voltage of 4.0V DC.

Company reserves the right to improve product design , functions and reliability without notice.

REV: A

Rating and Characteristics Curvers (ACDBC540-HF)

Fig.1 - Typical Forward Current Derating Curve

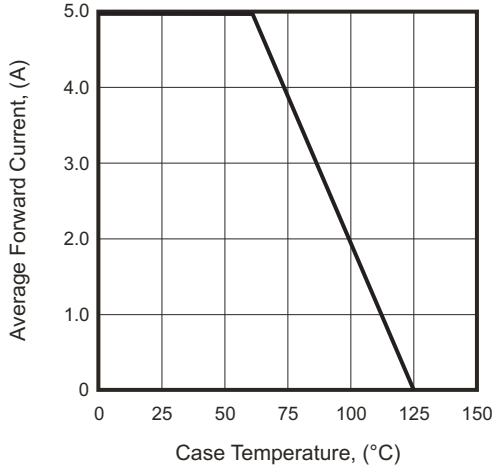

Fig.2 - Typical Forward Characteristics

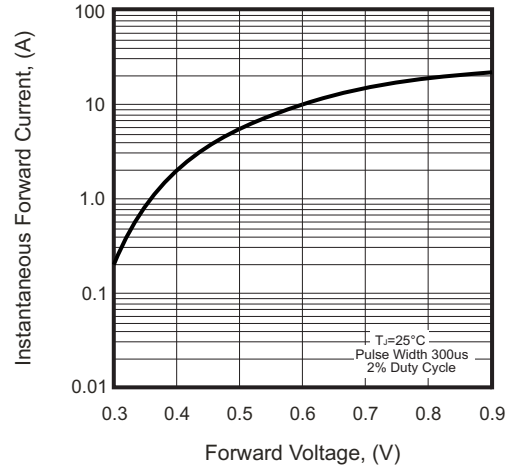

Fig.3 - Maximum Non-repetitive Forward Surge Current

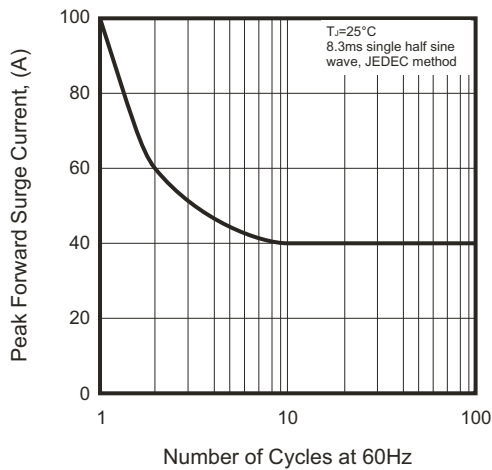

Fig.4 - Typical Reverse Characteristics

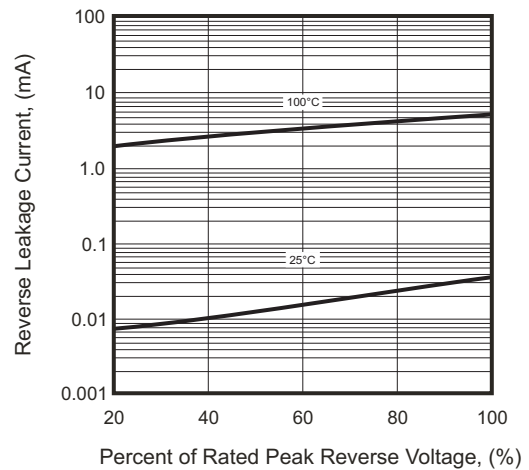
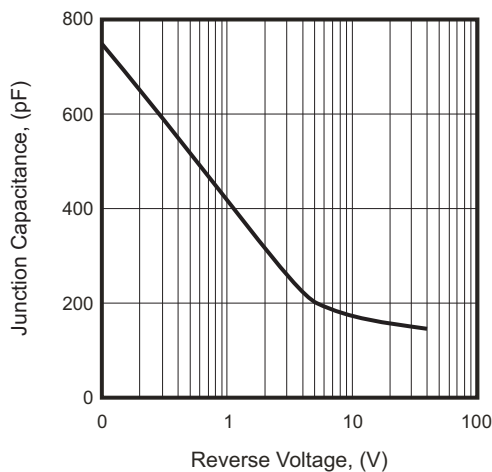

Fig.5 - Typical Junction Capacitance



Company reserves the right to improve product design, functions and reliability without notice.

Reel Taping Specification



DO-214AB (SMC)	SYMBOL	A	B	C	d	D	D ₁	D ₂
	(mm)	6.30 MAX.	8.60 MAX.	2.90 MAX.	1.50 ± 0.10	330 ± 2.00	50 MIN.	13.50 ± 1.00
	(inch)	0.248 MAX.	0.339 MAX.	0.114 MAX.	0.059 ± 0.004	13.00 ± 0.079	1.969 MIN.	0.531 ± 0.039

DO-214AB (SMC)	SYMBOL	E	F	P	P ₀	P ₁	W	W ₁
	(mm)	1.75 ± 0.10	7.50 ± 0.05	8.00 ± 0.10	4.00 ± 0.10	2.00 ± 0.05	16.00 ± 0.30	22.40 MAX.
	(inch)	0.069 ± 0.004	0.295 ± 0.002	0.315 ± 0.004	0.157 ± 0.004	0.079 ± 0.002	0.630 ± 0.012	0.882 MAX.

Company reserves the right to improve product design, functions and reliability without notice.

REV: A

Marking Code

Part Number	Marking Code
ACDBC540-HF	540

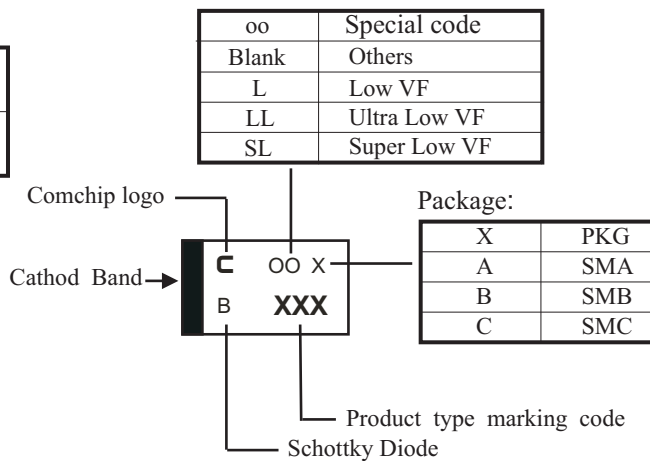

xxx = Product type marking code

Suggested PAD Layout

SIZE	DO-214AB (SMC)	
	(mm)	(inch)
A	3.30	0.130
B	2.50	0.098
C	4.40	0.173
D	6.80	0.268
E	9.40	0.370

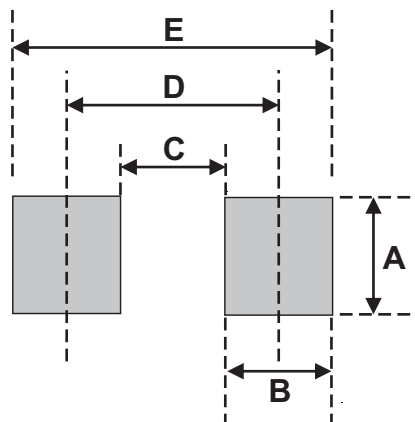

Note:

1. The pad layout is for reference purposes only.

Standard Packaging

Case Type	REEL PACK	
	REEL (pcs)	Reel Size (inch)
DO-214AB (SMC)	3,000	13