

Assembly Instructions for - 37391

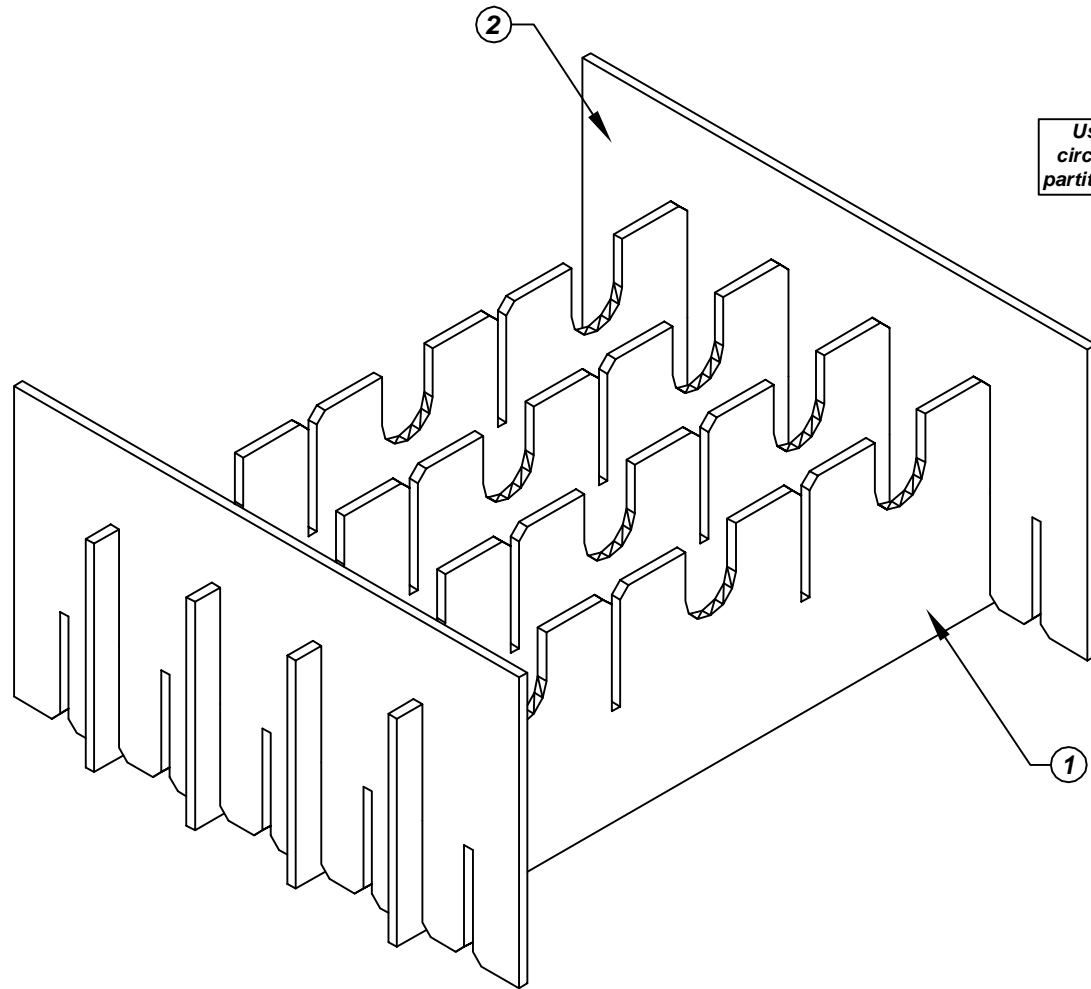

Use only the circled slots for partition assembly

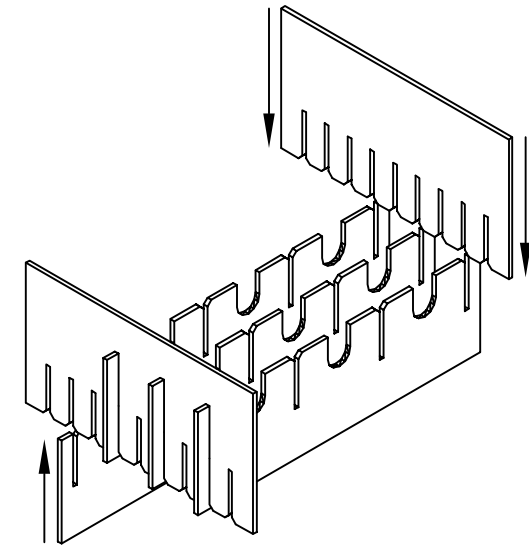
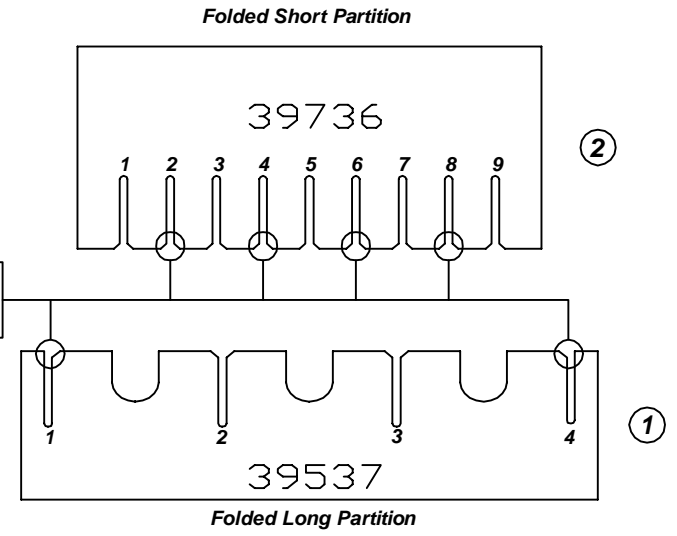

Made in America

F/N ①	Part # 39537	Dimensions: 12" x 18-5/8"	Description: 406/468-LP-10/30 Long Partition	Qty: 4
F/N ②	Part # 39736	Dimensions: 16-1/4" x 15"	Description: 468-SP-10 Short Partition	Qty: 2

37391 - 5 Cell Inplant Handler Cell Size - 8" x 16-5/8" x 2-3/4"

Notes:
For use with the following storage container & lid:
37527 - Storage Container
37554 - Lid

PROTEKTIVE PAK
13520 MONTE VISTA AVENUE, CHINO, CA 91710
PHONE (909) 627-2578, FAX (909) 363-7331
ProtektivePak.com

PROTEKTIVE PAK
BURIED CONDUCTIVE LAYER

DRAWING NUMBER
IPH-37391

DATE
Dec.
2007