



LoRa[®] Technology Evaluation Suite User's Guide

Note the following details of the code protection feature on Microchip devices:

- Microchip products meet the specification contained in their particular Microchip Data Sheet.
- Microchip believes that its family of products is one of the most secure families of its kind on the market today, when used in the intended manner and under normal conditions.
- There are dishonest and possibly illegal methods used to breach the code protection feature. All of these methods, to our knowledge, require using the Microchip products in a manner outside the operating specifications contained in Microchip's Data Sheets. Most likely, the person doing so is engaged in theft of intellectual property.
- Microchip is willing to work with the customer who is concerned about the integrity of their code.
- Neither Microchip nor any other semiconductor manufacturer can guarantee the security of their code. Code protection does not mean that we are guaranteeing the product as "unbreakable."

Code protection is constantly evolving. We at Microchip are committed to continuously improving the code protection features of our products. Attempts to break Microchip's code protection feature may be a violation of the Digital Millennium Copyright Act. If such acts allow unauthorized access to your software or other copyrighted work, you may have a right to sue for relief under that Act.

Information contained in this publication regarding device applications and the like is provided only for your convenience and may be superseded by updates. It is your responsibility to ensure that your application meets with your specifications. MICROCHIP MAKES NO REPRESENTATIONS OR WARRANTIES OF ANY KIND WHETHER EXPRESS OR IMPLIED, WRITTEN OR ORAL, STATUTORY OR OTHERWISE, RELATED TO THE INFORMATION, INCLUDING BUT NOT LIMITED TO ITS CONDITION, QUALITY, PERFORMANCE, MERCHANTABILITY OR FITNESS FOR PURPOSE. Microchip disclaims all liability arising from this information and its use. Use of Microchip devices in life support and/or safety applications is entirely at the buyer's risk, and the buyer agrees to defend, indemnify and hold harmless Microchip from any and all damages, claims, suits, or expenses resulting from such use. No licenses are conveyed, implicitly or otherwise, under any Microchip intellectual property rights unless otherwise stated.

Microchip received ISO/TS-16949:2009 certification for its worldwide headquarters, design and wafer fabrication facilities in Chandler and Tempe, Arizona; Gresham, Oregon and design centers in California and India. The Company's quality system processes and procedures are for its PIC® MCUs and dsPIC® DSCs, KEELOQ® code hopping devices, Serial EEPROMs, microperipherals, nonvolatile memory and analog products. In addition, Microchip's quality system for the design and manufacture of development systems is ISO 9001:2000 certified.

**QUALITY MANAGEMENT SYSTEM
CERTIFIED BY DNV
= ISO/TS 16949 =**

Trademarks

The Microchip name and logo, the Microchip logo, AnyRate, dsPIC, FlashFlex, flexPWR, Heldo, JukeBlox, KeeLoq, KeeLoq logo, Klear, LANCheck, LINK MD, MediaLB, MOST, MOST logo, MPLAB, OptoLyzer, PIC, PICSTART, PIC32 logo, RightTouch, SpyNIC, SST, SST Logo, SuperFlash and UNI/O are registered trademarks of Microchip Technology Incorporated in the U.S.A. and other countries.

ClockWorks, The Embedded Control Solutions Company, ETHERSYNCH, Hyper Speed Control, HyperLight Load, IntelliMOS, mTouch, Precision Edge, and QUIET-WIRE are registered trademarks of Microchip Technology Incorporated in the U.S.A.

Analog-for-the-Digital Age, Any Capacitor, AnyIn, AnyOut, BodyCom, chipKIT, chipKIT logo, CodeGuard, dsPICDEM, dsPICDEM.net, Dynamic Average Matching, DAM, ECAN, EtherGREEN, In-Circuit Serial Programming, ICSP, Inter-Chip Connectivity, JitterBlocker, KlearNet, KlearNet logo, MiWi, motorBench, MPASM, MPF, MPLAB Certified logo, MPLIB, MPLINK, MultiTRAK, NetDetach, Omniscient Code Generation, PICDEM, PICDEM.net, PICkit, PICtail, PureSilicon, RightTouch logo, REAL ICE, Ripple Blocker, Serial Quad I/O, SQL, SuperSwitcher, SuperSwitcher II, Total Endurance, TSHARC, USBCheck, VariSense, ViewSpan, WiperLock, Wireless DNA, and ZENA are trademarks of Microchip Technology Incorporated in the U.S.A. and other countries.

SQTP is a service mark of Microchip Technology Incorporated in the U.S.A.

Silicon Storage Technology is a registered trademark of Microchip Technology Inc. in other countries.

GestIC is a registered trademarks of Microchip Technology Germany II GmbH & Co. KG, a subsidiary of Microchip Technology Inc., in other countries.

All other trademarks mentioned herein are property of their respective companies.

© 2016, Microchip Technology Incorporated, Printed in the U.S.A., All Rights Reserved.

ISBN: 978-1-5224-0549-8

Object of Declaration: LoRa® Technology Evaluation Suite

EU Declaration of Conformity

Manufacturer: Microchip Technology Inc.
2355 W. Chandler Blvd.
Chandler, Arizona, 85224-6199
USA

This declaration of conformity is issued by the manufacturer.

The development/evaluation tool is designed to be used for research and development in a laboratory environment. This development/evaluation tool is not a Finished Appliance, nor is it intended for incorporation into Finished Appliances that are made commercially available as single functional units to end users under EU EMC Directive 2004/108/EC and as supported by the European Commission's Guide for the EMC Directive 2004/108/EC (8th February 2010).

This development/evaluation tool complies with EU RoHS2 Directive 2011/65/EU.

This development/evaluation tool, when incorporating wireless and radio-telecom functionality, is in compliance with the essential requirement and other relevant provisions of the R&TTE Directive 1999/5/EC and the FCC rules as stated in the declaration of conformity provided in the module datasheet and the module product page available at www.microchip.com.

For information regarding the exclusive, limited warranties applicable to Microchip products, please see Microchip's standard terms and conditions of sale, which are printed on our sales documentation and available at www.microchip.com.

Signed for and on behalf of Microchip Technology Inc. at Chandler, Arizona, USA

Derek Carlson
VP Development Tools

12-Sep-14
Date

LoRa[®] Technology Evaluation Suite User's Guide

NOTES:

Table of Contents

Preface	9
Chapter 1. Getting Started With The LoRa[®] Suite	
1.1 Suite Overview	15
1.2 Document Terminology	15
1.3 Suite Objectives	18
1.4 Utility Description	20
1.5 Utility Behavior	20
1.6 Utility Layout and Navigation	21
1.6.1 Navigation Menu	21
1.6.2 Find Devices	22
1.6.3 Device List	22
1.6.4 Model View Panel	23
1.6.5 Utility Console	23
Chapter 2. Installation	
2.1 Overview	25
2.2 Features	25
2.3 Installation Instructions	26
2.3.1 Installation Process	26
2.3.2 Component Selection	28
2.3.2.1 Applications	28
2.3.2.2 Server Application	28
2.3.2.3 Redistributables	28
2.3.3 Installation Finalization	28
2.3.4 Uninstallation	31
2.3.5 Installing Java Redistributable RE8	32
2.3.6 Installing Docker Toolbox	35
Chapter 3. System Preparation	
3.1 Launch Oracle VM VirtualBox	39
3.2 Add Port Forwarding Rules for Oracle VM VirtualBox Manager	40
3.3 Assign Static IP	43
Chapter 4. Server Setup	
4.1 Launch Docker Quickstart Terminal	47
4.2 Load Docker Image	48
4.3 View Docker Image	49
4.4 Create Docker Container	49
4.5 Start Container	50
4.6 Stop Container	50
4.7 Restart Container	51
4.8 Docker Documentation	51

LoRa[®] Technology Evaluation Suite User's Guide

Chapter 5. Network Evaluation Kit Setup

5.1 Connect LoRa Technology Devices	53
5.2 Connect Devices to LoRa Development Utility	54
5.3 Configure Gateway	55
5.4 Configure RN Module for Auto-Create Personalization	56
5.5 Add Server to Device List	58
5.6 Connect Utility to MySQL IP Address	59

Chapter 6. Additional Setup for Operation at 915 MHz

6.1 Configure RN Module for 8 Channels	61
6.2 Issue Unconfirmed Dummy Uplink	64
6.3 Change Gateway Region	65

Chapter 7. Auto-Create Example Implementation

7.1 Issue Unconfirmed Uplink Using Auto-Create Personalization	67
7.2 Confirm Gateway Capture	68
7.3 View Uplink Message in Database	69

Chapter 8. Activation-By-Personalization (ABP) Example Implementation

8.1 Create Provisioned (ABP) Credentials for Server	71
8.2 Confirm ABP Addition in Database	74
8.3 Save ABP Credentials to RN Module	76
8.4 Join Using ABP Credentials	77
8.5 Issue Unconfirmed Uplink Using ABP Personalization	79
8.6 Confirm Gateway Capture	80
8.7 View Uplink in Database	82

Chapter 9. Over-The-Air Example Implementation

9.1 Create a New Application Inside the Server	85
9.2 Create OTAA Credentials in Server Application	87
9.3 Confirm Server Application Addition to Database	89
9.4 Confirm OTAA Device Addition to Database	90
9.5 Save OTAA Credentials to RN Module	92
9.6 Join Server Using OTAA Credentials	93
9.7 Issue Unconfirmed Uplink Using OTAA Personalization	94
9.8 Confirm Gateway Capture	95
9.9 View Uplink in Database	97

Chapter 10. Queue Downlink For an End Device

10.1 Queue Downlink	99
---------------------------	----

Chapter 11. Receiving Queued Downlink Messages

11.1 Reconfigure RN Module for ABP	103
11.2 Issue Confirmed Uplink	104
11.3 Observe Downlink Response	105

Chapter 12. RN Modules

12.1 Overview	107
12.2 Features	107
12.3 Description	108

12.3.1 LoRaWAN Tab Descriptions	108
12.3.2 RN Module Channel Tab Descriptions	127
12.3.3 RN Module FCC Tab Descriptions	133
12.3.4 RN Module Radio Tab Descriptions	154
12.3.5 RN Module Device Firmware Update (DFU) Tab Descriptions	173
Chapter 13. Gateways	
13.1 Overview	179
13.2 Features	179
13.3 Description	179
13.3.1 Gateway Tab Descriptions	180
Chapter 14. Gateway Behavior Operation	
14.1 Overview	197
14.2 Power and Communication Connections	197
14.2.1 USB	197
14.2.2 Ethernet	197
14.3 Interaction, Navigation, and Display	197
14.4 Commands	200
14.5 General Application Description	208
14.6 Gateway Configuration	211
14.7 SD Card Configuration	212
14.8 Bootloader and Firmware Updates	213
Chapter 15. LoRa® Technology Server and Database	
15.1 Overview	217
15.2 Features	217
15.3 Description	217
15.3.1 Server Tab Description	218
15.3.2 Database Tab Description	230
15.3.3 Data Traffic Table Description	233
15.3.4 Application Servers Table Description	237
15.3.5 Gateway Units Table Description	238
15.3.6 ABP Devices Table Description	243
15.3.7 OTAA Devices Table Description	246
Worldwide Sales and Service	249

LoRa[®] Technology Evaluation Suite User's Guide

NOTES:

Preface

NOTICE TO CUSTOMERS

All documentation becomes dated, and this manual is no exception. Microchip tools and documentation are constantly evolving to meet customer needs, so some actual dialogs and/or tool descriptions may differ from those in this document. Please refer to our website (www.microchip.com) to obtain the latest documentation available.

Documents are identified with a “DS” number. This number is located on the bottom of each page, in front of the page number. The numbering convention for the DS number is “DSXXXXXXXXA”, where “XXXXXXXX” is the document number and “A” is the revision level of the document.

For the most up-to-date information on development tools, see the MPLAB[®] IDE online help. Select the Help menu, and then Topics to open a list of available online help files.

INTRODUCTION

This chapter contains general information that will be useful to know when using the Microchip LoRa[™] Technology Network Evaluation Kit. Topics discussed in this chapter include:

- [Document Layout](#)
- [Conventions Used in this Guide](#)
- [Recommended Reading](#)
- [The Microchip website](#)
- [Development Systems Customer Change Notification Service](#)
- [Customer Support](#)
- [Revision History](#)

DOCUMENT LAYOUT

This document describes how to use the LoRa[®] Technology Evaluation Kit along with the LoRa Development Utility Application Graphic User Interface (GUI) as a demonstration platform to show how to create and manage a LoRa Technology Network. The document is organized as follows:

- **Chapter 1. “Getting Started With The LoRa[®] Suite”** – This chapter describes the layout of the LoRa Technology Development Utility, menu navigation, terminology, device models, and general operation details.
- **Chapter 2. “Installation”** – This chapter describes the contents of the LoRa Technology Development Suite Installation Package, basic requirements and uninstallation process.
- **Chapter 3. “System Preparation”** – This chapter describes the process of configuring Oracle[®] VM Virtual Box Port Forwarding, and configuring a static IP address.
- **Chapter 4. “Server Setup”** – This chapter describes how to use docker to manage the LoRa Evaluation server.

LoRa[®] Technology Evaluation Suite User's Guide

- **Chapter 5. “Network Evaluation Kit Setup”** – This chapter describes how to connect the LoRa Evaluation Kit boards to the Utility and configure parameter settings.
- **Chapter 6. “Additional Setup for Operation at 915 MHz”** – This chapter describes how to configure the Mote for eight channels of operation, and change the operating region of the Gateway.
- **Chapter 7. “Auto-Create Example Implementation”** – This chapter describes how to connect a Mote to the Evaluation server using the Auto-Create form of Personalization.
- **Chapter 8. “Activation-By-Personalization (ABP) Example Implementation”** – This chapter describes how to connect a Mote to the Evaluation server using the Activation-By-Personalization.
- **Chapter 9. “Over-The-Air Example Implementation”** – This chapter describes how to create a server Application and connect a Mote to the Evaluation server through use of the new Application and Over-The-Air Activation (OTAA).
- **Chapter 10. “Queue Downlink For an End Device”** – This chapter describes how to queue a Downlink Message for response to a joined Mote upon next confirmed Uplink.
- **Chapter 11. “Receiving Queued Downlink Messages”** – This chapter describes how to view the received Downlink.
- **Chapter 12. “RN Modules”** – This chapter goes into full detail of navigating the RN Module model view, discussing each interactive element, method of use and coordinating effect.
- **Chapter 13. “Gateways”** – This chapter goes into full detail of the Gateway model view, discussing each interactive element, method of use and coordinating effect.
- **Chapter 14. “Gateway Behavior Operation”** – This chapter describes the communication methods, setup, configuration and the hardware requirements for getting started with the LoRa Technology infrastructure.
- **Chapter 15. “LoRa[®] Technology Server and Database”** – This chapter goes into full detail of both tab options within the Server model view, discussing each interactive element, method of use and coordinating effect.

CONVENTIONS USED IN THIS GUIDE

This manual uses the following documentation conventions:

DOCUMENTATION CONVENTIONS

Description	Represents	Examples
Arial font:		
Italic characters	Referenced books	<i>MPLAB[®] IDE User's Guide</i>
	Emphasized text	...is the <i>only</i> compiler...
Initial caps	A window	the Output window
	A dialog	the Settings dialog
	A menu selection	select Enable Programmer
Quotes	A field name in a window or dialog	"Save project before build"
Underlined, italic text with right angle bracket	A menu path	<u><i>File>Save</i></u>
Bold characters	A dialog button	Click OK
	A tab	Click the Power tab
N'Rnnnn	A number in verilog format, where N is the total number of digits, R is the radix and n is a digit.	4'b0010, 2'hF1
Text in angle brackets < >	A key on the keyboard	Press <Enter>, <F1>
Courier New font:		
Plain Courier New	Sample source code	#define START
	Filenames	autoexec.bat
	File paths	c:\mcc18\h
	Keywords	_asm, _endasm, static
	Command-line options	-Opa+, -Opa-
	Bit values	0, 1
	Constants	0xFF, 'A'
Italic Courier New	A variable argument	<i>file.o</i> , where <i>file</i> can be any valid filename
Square brackets []	Optional arguments	mcc18 [options] <i>file</i> [options]
Curly brackets and pipe character: { }	Choice of mutually exclusive arguments; an OR selection	errorlevel {0 1}
Ellipses...	Replaces repeated text	var_name [, var_name...]
	Represents code supplied by user	void main (void) { ... }

LoRa[®] Technology Evaluation Suite User's Guide

RECOMMENDED READING

This user's guide describes the contents and uses of the LoRa Technology Development Suite. Other useful documents are listed below. The following Microchip documents are available and recommended as supplemental reference resources:

LoRa[®] Mote User's Guide (DS40001808)

This user's guide describes how the LoRa Mote demonstration board is used with the LoRa Technology RN Modules.

RN2483 Low-Power Long-Range LoRa[®] Technology Transceiver Module Data Sheet (DS50002346)

This data sheet provides detailed specifications for the RN2483 module.

RN2483 LoRa[®] Technology Module Command Reference User's Guide (DS40001784)

This user's guide provides specifications about the commands to be used with the LoRa module.

RN2483 LoRa[®] Technology PICtail™/PICtail Plus Daughter Board User's Guide (DS50002366)

This user's guide describes how to configure and use the LoRa Daughter Board.

RN2903 Low-Power Long-Range LoRa[®] Technology Transceiver Module Data Sheet (DS50002390)

This data sheet provides detailed specifications for the RN2903 module.

RN2903 LoRa[®] Technology Module Command Reference User's Guide (DS40001811)

This user's guide provides specifications about the commands to be used with the LoRa module.

RN2903 LoRa[®] Technology PICtail™/PICtail Plus Daughter Board User's Guide (DS50002424)

This user's guide describes how to configure and use the LoRa Daughter Board. To obtain any of Microchip's documents, visit the Microchip website at www.microchip.com.

THE MICROCHIP WEBSITE

Microchip provides online support via our website at www.microchip.com. This website is used as a means to make files and information easily available to customers. Accessible by using your favorite Internet browser, the website contains the following information:

- **Product Support** – Data sheets and errata, application notes and sample programs, design resources, user's guides and hardware support documents, latest software releases and archived software
- **General Technical Support** – Frequently Asked Questions (FAQs), technical support requests, online discussion groups, Microchip consultant program member listing
- **Business of Microchip** – Product selector and ordering guides, latest Microchip press releases, listing of seminars and events, listings of Microchip sales offices, distributors and factory representatives

DEVELOPMENT SYSTEMS CUSTOMER CHANGE NOTIFICATION SERVICE

Microchip's customer notification service helps keep customers current on Microchip products. Subscribers will receive e-mail notification whenever there are changes, updates, revisions or errata related to a specified product family or development tool of interest.

To register, access the Microchip website at www.microchip.com, click on Customer Change Notification and follow the registration instructions.

The Development Systems product group categories are:

- **Compilers** – The latest information on Microchip C compilers, assemblers, linkers and other language tools. These include all MPLAB C compilers; all MPLAB assemblers (including MPASM™ assembler); all MPLAB linkers (including MPLINK™ object linker); and all MPLAB librarians (including MPLIB™ object librarian).
- **Emulators** – The latest information on Microchip in-circuit emulators. This includes the MPLAB REAL ICE™ and MPLAB ICE 2000 in-circuit emulators.
- **In-Circuit Debuggers** – The latest information on the Microchip in-circuit debuggers. This includes MPLAB ICD 3 in-circuit debuggers and PICKit™ 3 debug express.
- **MPLAB® X IDE** – The latest information on Microchip MPLAB IDE, the Windows® Integrated Development Environment for development systems tools. This list is focused on the MPLAB IDE, MPLAB IDE Project Manager, MPLAB Editor and MPLAB SIM simulator, as well as general editing and debugging features.
- **Programmers** – The latest information on Microchip programmers. These include production programmers such as MPLAB REAL ICE in-circuit emulator, MPLAB ICD 3 in-circuit debugger and MPLAB PM3 device programmers. Also included are nonproduction development programmers such as PICSTART® Plus and PICKit 2 and 3.

CUSTOMER SUPPORT

Users of Microchip products can receive assistance through several channels:

- Distributor or Representative
- Local Sales Office
- Field Application Engineer (FAE)
- Technical Support

Customers should contact their distributor, representative or field application engineer (FAE) for support. Local sales offices are also available to help customers. A listing of sales offices and locations is included in the back of this document.

Technical support is available through the website at:

<http://www.microchip.com/support>.

REVISION HISTORY

Revision A (May 2016)

Initial release of the document.

LoRa[®] Technology Evaluation Suite User's Guide

NOTES:

Chapter 1. Getting Started With The LoRa[®] Suite

1.1 SUITE OVERVIEW

The LoRa[®] Technology Evaluation Suite is an installation package that includes all necessary components for evaluation of an example LoRa system. Included in the Suite is the LoRa Development Utility, 'mchplora' example server Docker[™] Image, and Java[™] 1.8 Runtime Redistributable.

Working through the objects outlined in this document will teach the three methods of network admittance used by Motes: auto-create, personalization, over-the-air. Server applications will be discussed, along with queuing downlink response messages.

The LoRa Technology Development Utility is intended to be used with Microchip's LoRa Network Evaluation Kit. It can additionally be used along with Microchip's stand-alone LoRa development tools, or custom-created products/prototypes capable of USB-to-serial communication with the RN Module, necessary for command processing.

The 'mchplora' example server Docker Image file is supplied to offer an out-of-box capable example server. Use of the example server requires a third-party open source program, not included in the LoRa Suite installation package. Refer to [Section 2.3.6 "Installing Docker Toolbox"](#) for additional information.

1.2 DOCUMENT TERMINOLOGY

Because of the complex nature of this system, there are key phrases and keywords used throughout this document which may not be familiar.

Listed below are keywords that may be encountered throughout the documents:

Docker

- **Docker Toolbox** – Installs Docker Client, Machine, Compose and Kitematic; available for both Windows[®] and MAC[®]. Refer to: <https://www.docker.com/products/docker-toolbox>.

What's in the Toolbox:

- Docker Engine
 - Docker Compose
 - Docker Machine
 - Docker Kitematic
 - Docker Quickstart Terminal
 - Oracle[®] VM Virtual Box
- **Docker Engine** – A lightweight runtime and robust tooling that builds and runs Docker containers. Runs on Linux[®] to create the operating environment for distributed applications. The in-host Daemon communicates with the Docker client to execute commands to build, ship and run containers. Refer to: <https://www.docker.com/products/docker-engine>.
 - **Docker Compose** – Allows multi-container applications with all its dependencies to be defined into a single file, spinning the application up into a single command. Refer to: <https://www.docker.com/products/docker-compose>.

LoRa[®] Technology Evaluation Suite User's Guide

- **Docker Machine** – Tool used to install Docker Engine on virtual host, and manage host with commands. Requires the use of Oracle Virtual Box; on Windows and MAC installation of Docker Toolbox, will automatically install Virtual Box. Refer to: <https://docs.docker.com/machine/>.
- **Docker Kitematic** – A simple, yet powerful graphic user interface, created to run containers. This application is not used for this user's guide. Refer to: <https://kitematic.com/>.
- **Docker Quickstart Terminal** – This is a terminal emulation program which allows access to the Docker Engine; used on Windows and MAC operating systems. This is not required for Linux users, as the Docker Engine can be accessed directly through Linux Terminal navigation.
- **Virtual Machine** – Emulation of a particular computer system. Operates based upon computer architecture, with functions of a real or hypothetical computer. Implementations may work with specialized software, hardware, or a combination of both.
- **Oracle VM Virtual Box** – Virtual Machine program installed along with the Docker Toolbox for use with Docker Machine. Refer to: <https://www.oracle.com/technet-work/server-storage/virtualbox/overview/index.html>.
- **Image** – The basis of containers. A read-only template used by Docker for repositories. Refer to: <https://docs.docker.com/engine/userguide/containers/dockerimages/>.
- **Container** – Active repository uncompressed from a Docker Image. Containers are created from image files with an added read-write file system layer, and can be run in isolation.

Utility

- **Device Model** – Collection of variables capable of being context-saved, used to define an object.
Utility Device Models:
 - RN Module
 - Gateway
 - Server
 - COM
- **Model View Controller** – A software design pattern useful for implementing user interfaces on a computer. Used to separate internally represented information from the way the information is presented. For example, storage of date information e.g., 1/1/2015 vs displayed method of: January 1, 2015. Useful for GUI development; it is often referred to as a Model View.
Utility Model Views:
 - RN Module – [Chapter 12. “RN Modules”](#)
 - Gateway – [Chapter 13. “Gateways”](#)
 - Server – [Chapter 15. “LoRa[®] Technology Server and Database”](#)
 - COM – [Chapter 12. “RN Modules”](#)
- **Titled Pane** – Panel with a title that can be collapsed; opened, and closed.
- **Panel** – The simplest container class; provides space in which an application can attach any other component, including other panels.
- **Scroll Panel** – Provides a horizontal or vertical scrollable view of a component. When screen real estate is limited, a scroll pane can be used to display a component that is large, or one whose size can change dynamically.
- **Text Field** – Text component object which allows the editing of a single line of text.

Getting Started With The LoRa® Suite

- **Combo Box** – A drop-down field containing a specific list of possible values available to a variable configuration. The combo boxes used with the utility are not editable.
- **Radio Button** – An item that can be selected or deselected, and which displays its state. Used for Boolean variable configuration within the utility.
- **Push Button** – Object used to initiate an action or event when pressed.
- **Tabs** – Collection of panels organized into sections for display by the Model View.
- **Table View** – Designed to visualize an unlimited number of rows of data, broken out into descriptive columns.
- **Polling** – Periodic, or repeating action of requesting or waiting for information.

Utility Validators

- **Hex** – A value lead with the distinguishing characters “0x”; must be between 0 – F.

FIGURE 1-1: HEX VALIDATOR



- **Decimal** – A numerical value; must be 0 – 9.

FIGURE 1-2: DECIMAL VALIDATOR

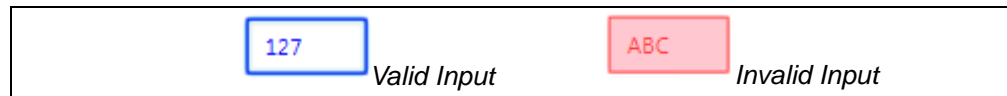

- **String (ASCII)** – Characters such as letters, numbers, symbols (0-9, A-Z, a-z, !@#\$, etc.).

FIGURE 1-3: ASCII VALIDATOR



- **IP** – (4-12) decimal value representing an Internet Protocol Address (0.0.0.0 – 255.255.255.255).

FIGURE 1-4: IP VALIDATOR



Note: Numerical range depends on Device Model variable. Text and field boards will be shown in blue if entered text is valid in format and range, otherwise the field will be shown in red. Refer to [Chapter 12. “RN Modules”](#), [Chapter 13. “Gateways”](#), and [Chapter 15. “LoRa® Technology Server and Database”](#) for more detail.

LoRa

- **Evaluation Server** – LoRa Server supplied with the LoRa Suite, packaged into Image file
 - Network Server – Server that maintains a record for each Mote.
 - Application Server – Server responsible for admitting OTA Motes to the network and for encrypting user data sent to, and decrypting user data received from the Mote. A single Application Server may be connected to many network and customer servers. The remote server or controller used for a given Mote is determined by the application to which the Mote is assigned.
 - Customer Server – A trivial implementation of the program used by the data owner to receive Mote data.
 - Network Controller – Receives transmission parameters used by the Mote and characteristics of the signal received by the gateway for each frame. It may perform operations using that data. For the provided Evolution server, only Automatic Data Rate (ADR) control for a Mote is available for use.
- **Server Application** – Custom Created (OTA) Application operating within the Evaluation Server
- **Mote** – The End Device of a LoRa Network.
- **Gateway** – Device responsible for forwarding data between Motes and a single LoRa network server.
- **Uplink** – Issuing a LoRaWAN[™] Transmission from an End Device to a Gateway
- **Downlink** – Issuing a LoRaWAN Transmission from a Gateway to an End Device
- **Upstream** – Data exchanged between Gateway and Server
- **Downstream** – Data exchanged between Server and Gateway

1.3 SUITE OBJECTIVES

The purpose of the LoRa Technology Development Suite User's Guide is to outline all steps necessary to use the material supplied to operate the LoRa Evolution Network. Further exploration and development of a LoRa system through use of the evaluation server should be simple upon completion of the objectives outlined in this guide.

Below are the objectives:

- Installation
- System Preparation
- Server Setup
- Network Evaluation Kit Setup
- Operation at 915 MHz
- Auto-Create
- Activation-By-Personalization (ABP)
- Over-The-Air (OTA)
- Queue Downlink Messages
- Receiving Downlink Message

A LoRa system can be implemented in many different ways. Operation of the evaluation system discussed in this document will be configured as shown in [Figure 1-5](#). For this configuration the LoRa Technology Evaluation Kit will be used.

Getting Started With The LoRa® Suite

FIGURE 1-5: LoRa® NETWORK EVALUATION SETUP

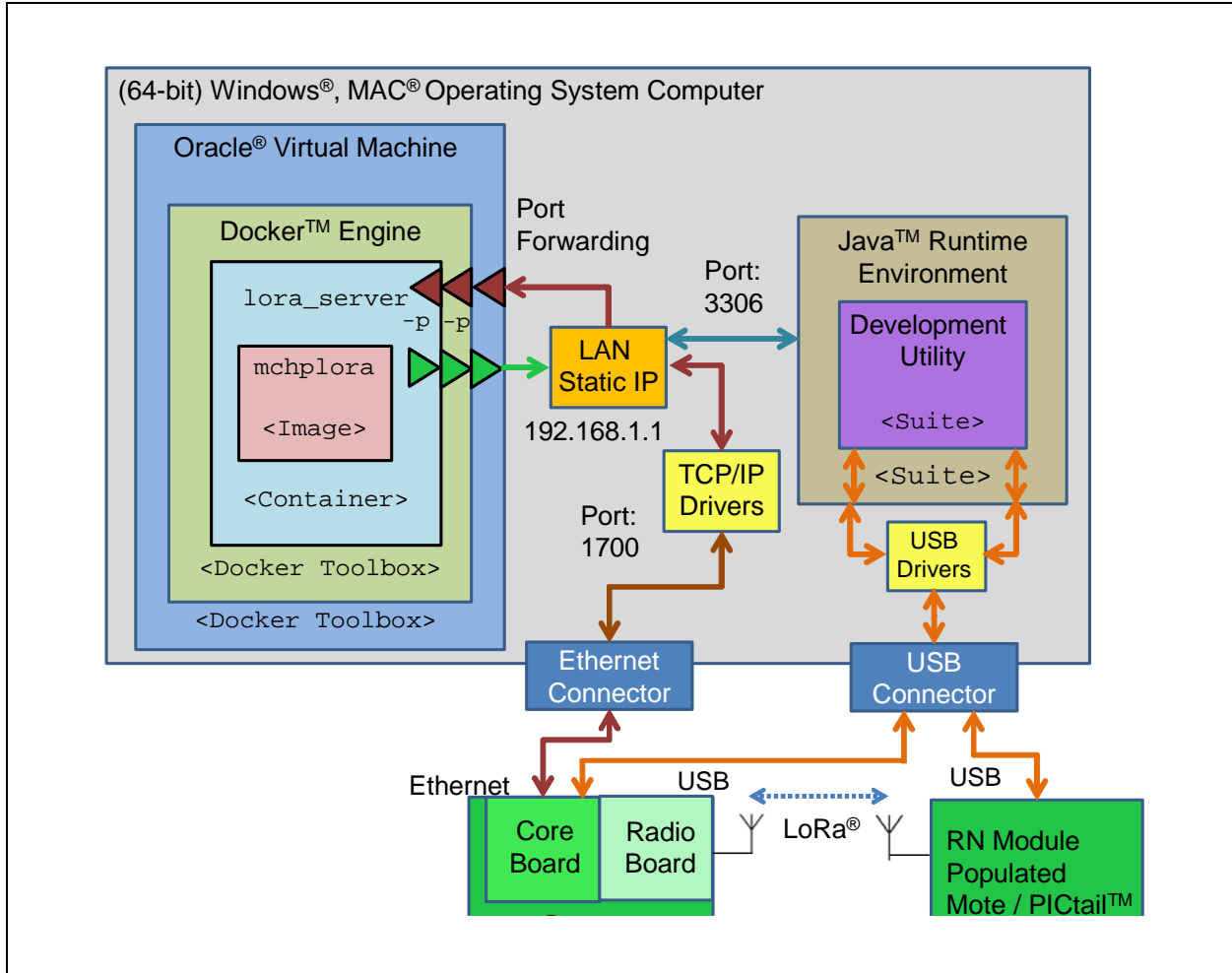

The LoRa Gateway board, consisting of the Core board, and Radio board attachment, is connected to the Host PC through USB, supplying both power and Serial communication. Additionally, an Ethernet cable is connected between the Core board and the PC's Local Area Network (LAN) connector; this is used for communication between Gateway and Server.

The RN Module populated development board (Mote or PICtail™/PICtail Plus) is connected to the same computer through its own USB connection, supplying both power and Serial communication.

From the Host PC, the program Docker Toolbox will be used. Using the Docker Toolbox allows the Oracle® Virtual Machine to operate, hosting the Docker Engine used to run the LoRa evaluation server. A static IP address is assigned to the LAN adapter settings, allowing for Gateway Traffic to be forwarded through the PC (1700) port to the Docker hosted evaluation server.

The LoRa Development Utility runs within the Java Runtime Environment. From the Utility commands and configurations, it can be issued from the PC to connected LoRa Technology Evaluation Kit boards. Database information is exchanged between the LoRa Utility and Docker-hosted evaluation server, through MySQL traffic (3306) port forwarding.

LoRa[®] Technology Evaluation Suite User's Guide

1.4 UTILITY DESCRIPTION

Use of the Development Utility requires installation of Java 1.8 Runtime Environment. Refer to [Section 2.3.5 “Installing Java Redistributable RE8”](#).

The Development Utility has been written in a threaded manner, and thus each Device Model instance runs independently. This allows for the user to operate all devices populated in the list parallel to one another.

For example, it is possible to be doing a bootloader operation to multiple Mote units simultaneously.

In addition, this allows for periodic data-request commands to be issued even when a device is not actively selected from the Device List.

For example, a Gateway that is populated in the Device List is currently polling statistical information, updating its Device Model variables. This will be processed by the Utility even when the Server is selected from the Device List, and its model view displays database information.

The Utility has been developed to support all commands capable of being issued, or received by Microchip's LoRa Gateway and RN Module devices; presented in an easy-to-follow visual user interface allowing for configuration/modifications, without knowledge of the command syntax. Additionally, the Utility is capable of exercising advanced script-driven test, or polling actions. Furthermore, the Utility abstracts and handles all MySQL communications with database and JSON communication with the evaluation server. Refer to [Chapter 12. “RN Modules”](#), [Chapter 13. “Gateways”](#), and [Chapter 15. “LoRa[®] Technology Server and Database”](#) for more advanced descriptions of each Device Model and its features.

1.5 UTILITY BEHAVIOR

The Development Utility can be launched by double clicking on the 'LoRaDevUtility.jar' executable file located in the LoRa Suite installation directory, *Applications* folder. The Utility supports three different possible Device Models, based upon the device type. Each Device Model uses its own Model View used for layout navigation. The Utility maintains its own dedicated General Console where all device interactions are displayed.

Upon launch, the Development Utility will initiate a scan for all available enumerated USB COM ports. Once finding an available COM port, the application will request the connected devices version information by issuing the string command `sys get ver` with appropriate `<CR><LF>` [`\r\n`] terminators added to conform with format expected by Microchip LoRa Gateway, RN Module devices.

Based upon the response message, the device is created as either a RN Module or Gateway, and is added to the Device List. If the incorrect or no response is received as a response from the device, it is considered to be a non-LoRa device, and is not added to the list. Devices selected in the list are each supported by their own Device Model, each with its own threaded Context Switched Model View; allowing for each device to maintain its own Console display, along with variable values.

At the top of the Utility is a simple context sensitive menu. The menu is used to remove Gateway or RN Module units from the Device List. It can additionally be used to either add or remove a Server Instance; only a single server is allowed in the Device List. A more detailed description of the Utility Menu is given in [Section 1.6.1 “Navigation Menu”](#).

1.6 UTILITY LAYOUT AND NAVIGATION

The layout for the Development Utility is divided as represented in [Figure 1-6](#).

FIGURE 1-6: LoRa® TECHNOLOGY UTILITY DEFAULT LAYOUT



1.6.1 Navigation Menu

The Utility Menu supplies a simple method of device removal, and has context behaviors. For instance, the Gateway menu option is disabled unless a Gateway device is currently selected from the list.

Below is a list of the available menu options, and expected behavior conditions:

- File
 - Close
Exits the Device Utility. This does not affect server status.
- Module
 - Bootloader Recovery
Scans and populates the Device List with all currently available COM ports without distinguishing if the connected device is a Microchip LoRa Technology product. This is intended to be used with RN Modules which received the `sys erase FW` command, but do not yet have updated application code. Refer to [Section 12.3.5 “RN Module Device Firmware Update \(DFU\) Tab Descriptions”](#) for more detail.

- Remove

Remove the currently selected RN Module from the Device List. Parameter value entered in the text fields will be lost if not previously issued to the RN Module device.

- Gateway
 - Remove

Remove the currently selected Gateway from the Device List. Parameter value entered in the text fields will be lost if not previously issued to the Gateway device.

- Server
 - Add

Create a Server Device instance to be populated on the Device List.

Docker needs to be installed and running the Server container for full-feature of the Server Device Model. Refer to [Chapter 3. "System Preparation"](#) and [Chapter 4. "Server Setup"](#) for additional information.

- Remove
- Remove the Server instance from the Device List.

This action will have no effect on the Docker-run Server/Database. Parameter values entered in the text fields will be lost if not previously issued to the SQL database.

- About
 - Help

Print to the General Console the latest build information details for the LoRa Development Utility.

1.6.2 Find Devices

The Device Scanner button is used to detect and add newly attached Microchip LoRa Technology devices to the list. Pressing the **Find LoRa Devices** button will result in the command `sys get ver` being issued to all available enumerated COM ports available to the application. All devices will respond to this command with board-specific information.

Example of expected responses:

- Gateway: Microchip LoRa Gateway Version 0.1.2
- RN Module: RN2903 0.9.5 Sep 02 2015 17:22:00

1.6.3 Device List

The Device List is populated either when the application is launched, or upon pressing the scan button. Once valid devices are found, their appropriate models are created, and a distinguishing name is given to populate the list. The Device List can be cleared through the stand method of device removal discussed within this user's guide.

Below are the Device Models capable of populating the list:

- RN Module – Development board, or end product populated with the LoRaWAN protocol capable module.
- Gateway – Development board created to communicate with LoRaWAN protocol capable end devices.
- Server – Supplied model view used to communicate with the evaluation Server, along with SQL database management. The Device List may only contain a single instance of a Server device.
- COM – Under special conditions, all available COM ports are scanned and populate to the Device List. Only the Device Firmware Update (**DFU**) tab will be available to COM device types. Operation of the **DFU** tab from the COM Device Model is the same as when being used from the RN Module. Refer to [Section 12.3.5 "RN Module Device Firmware Update \(DFU\) Tab Descriptions"](#) for additional details.

1.6.4 Model View Panel

The model viewer panel is populated with the appropriate model based upon the currently selected device inside the list. Each model view and layout is dependent upon the device type, a unique console displaying actions or commands performed by the device.

Refer to [Chapter 12. “RN Modules”](#), [Chapter 13. “Gateways”](#), and [Chapter 15. “LoRa® Technology Server and Database”](#) for more advanced descriptions of each Device Model, and its features.

1.6.5 Utility Console

The Development Utility general console is used to maintain a log of all created and destroyed devices. Clicking on the **Clear Log** push button inside the console ([Figure 1-6](#)), will remove all previous dialogue messages.

LoRa[®] Technology Evaluation Suite User's Guide

NOTES:

Chapter 2. Installation

2.1 OVERVIEW

The LoRa Technology Development Suite is used to install all necessary components to get a LoRa Technology Network system up and running. This includes the Development Utility, which was developed specifically to help allow the user to fully evaluate, develop, and implement a LoRa Technology Application, with use of the LoRa Network Evaluation Kit.

The intention of the LoRa Technology Development Suite is to supply a single package capable of making the introduction of running a LoRaWAN network easy.

An example LoRa server with database wrapped inside a `Docker` Image is included with the suite. This allows operation of a LoRaWAN network out of box, along with the use of Docker and the LoRa Development Utility.

Included with the suite is a copy of Java Runtime Environment RE8, which is required to be installed prior to the use of the LoRa Technology Development Utility. Additionally, the open-source third party program Docker is required for local Server/Database use. The installer Docker Toolbox is not included with the suite, but can be acquired free of cost from: www.docker.com.

Through use of Microchip's LoRa Technology Network Evaluation Kit, the user is capable of running the evaluation LoRa Technology Network without writing a single line of code, and only minimal configuration. Microchip's LoRa Gateway boards (core and RF) are used to capture Uplink Messages issued by end devices, such as Microchip's LoRa Mote or LoRa PICtail boards. To help in forming a better understanding of the LoRa System, all material required has been included with the LoRa Development Suite.

2.2 FEATURES

Windows, Apple[®] and Linux-based operating systems each have their own particular Installation Suites.

By default, all suite contents will be selected for installation, however the user can specify the desired content. The full contents of the LoRa Development Suite Installation Package are shown below:

- Applications
 - Development Utility
 - HID Bootloader (Windows supported only)
- Server Applications
 - Docker Server/Database Evaluation Image
- Redistributables
 - Java Runtime Environment 8.65 (64-bit; OS specific)

2.3 INSTALLATION INSTRUCTIONS

Select the installer package of the desired platform from the www.microchip.com/lora website. Once downloaded, launch the installer by double clicking the LoRa Technology Development Suite Installation. After a few moments, a splash screen will appear followed by the initial Setup page, see [Figure 2-1](#).

FIGURE 2-1: INSTALLATION LAUNCH



2.3.1 Installation Process

Following this screen will be Microchip's License Agreement, which must be accepted to proceed, see [Figure 2-2](#).

FIGURE 2-2: LICENSE AGREEMENT

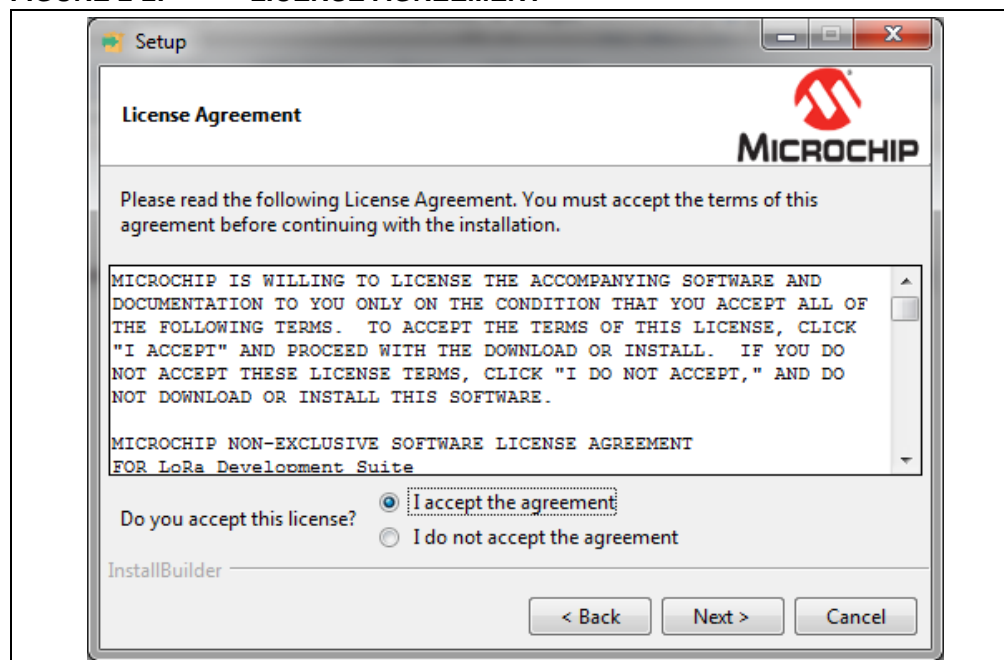

After agreeing to the License Agreement, a specific directory for installation can be selected by clicking on the Browse Directory Icon (📁). This will prompt the user, requesting a directory location, see [Figure 2-3](#).

FIGURE 2-3: SELECT DIRECTORY

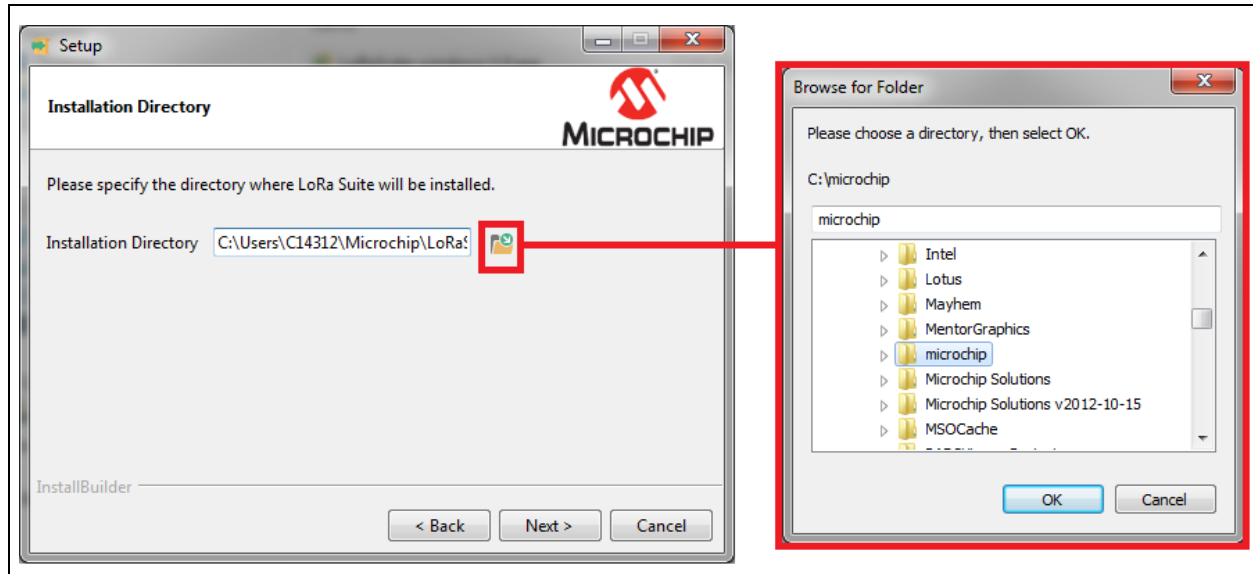

By default, the installation directory is *Microchip\LoRaSuite*. Once an installation directory has been specified, the user will be able to select which files to install, see [Figure 2-4](#).

FIGURE 2-4: INSTALLATION COMPONENT SELECTION

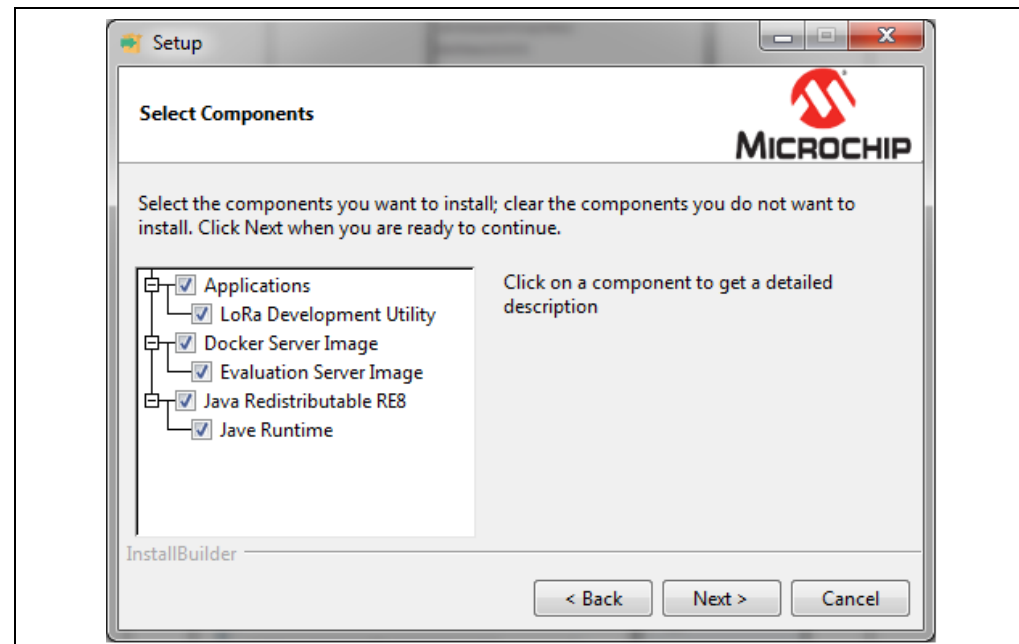

2.3.2 Component Selection

Below are listed the selectable contents of the Installation package:

2.3.2.1 APPLICATIONS

Development Utility

The Development Utility is intended to be used with the full Network Evaluation Kit. The Development Utility can connect and configure the Gateway, Mote, PICTail and RN Module design capable of serial command communication. Additionally, it can be used to manage the evaluation LoRa server and Database. The Utility is useful evaluation of a simple, but full LoRa Technology Network.

2.3.2.2 SERVER APPLICATION

Docker Server/Database Evaluation Image

This Image file has been compiled to supply a Docker Hosted LoRa Technology Server/Database evaluation platform. Through Docker, this image can be turned into a container, used to fully demonstrate an evaluation server, with minimal actions required by the user.

2.3.2.3 REDISTRIBUTABLES

Java Run Time Environment 8

This is the standard redistributable RE file supplied through Java for redistribution:
<http://www.oracle.com/technetwork/java/javase/downloads/index.html>.

2.3.3 Installation Finalization

After selecting the desired components, the process will prompt a final confirmation for installation, see [Figure 2-5](#).

FIGURE 2-5: INSTALLATION CONFIRMATION

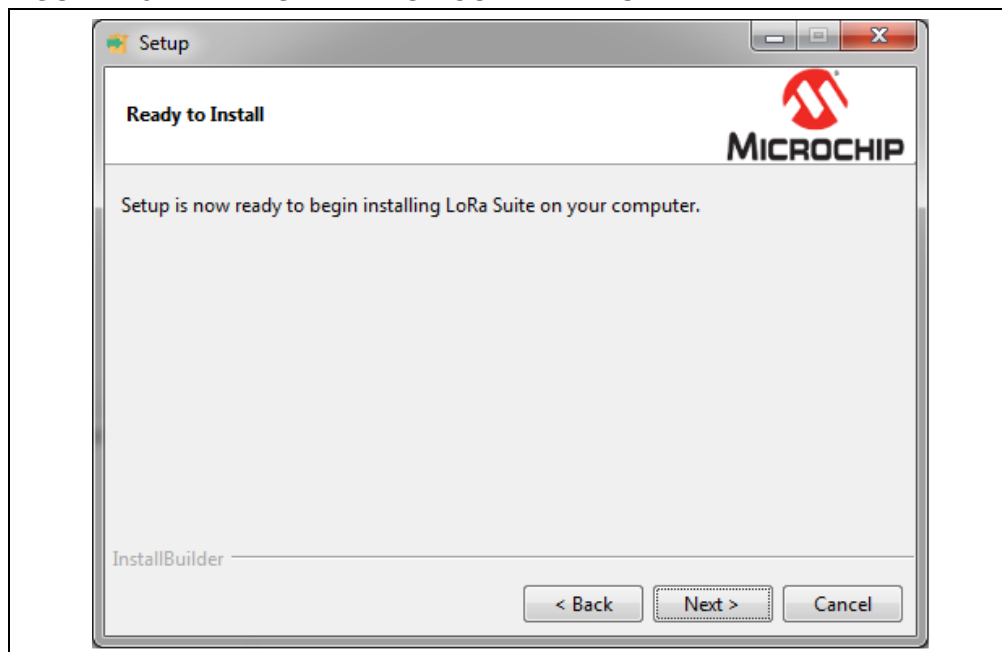

An installer process indicator will be shown as the files are unpackaged, see [Figure 2-6](#).

FIGURE 2-6: INSTALL PROCESS BAR

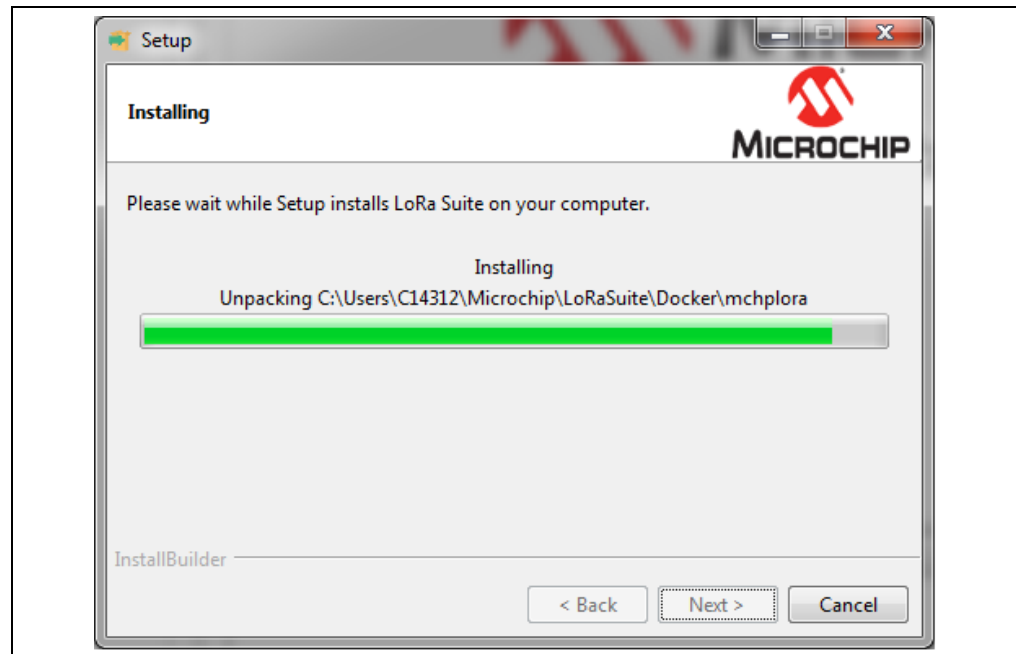

Upon completion of installation, see [Figure 2-7](#), the user will be given the option to view the latest Readme file, see [Figure 2-8](#). This Readme file is used to describe any recent changes or additions made to the LoRa Development Suite.

FIGURE 2-7: INSTALLATION FINALIZATION

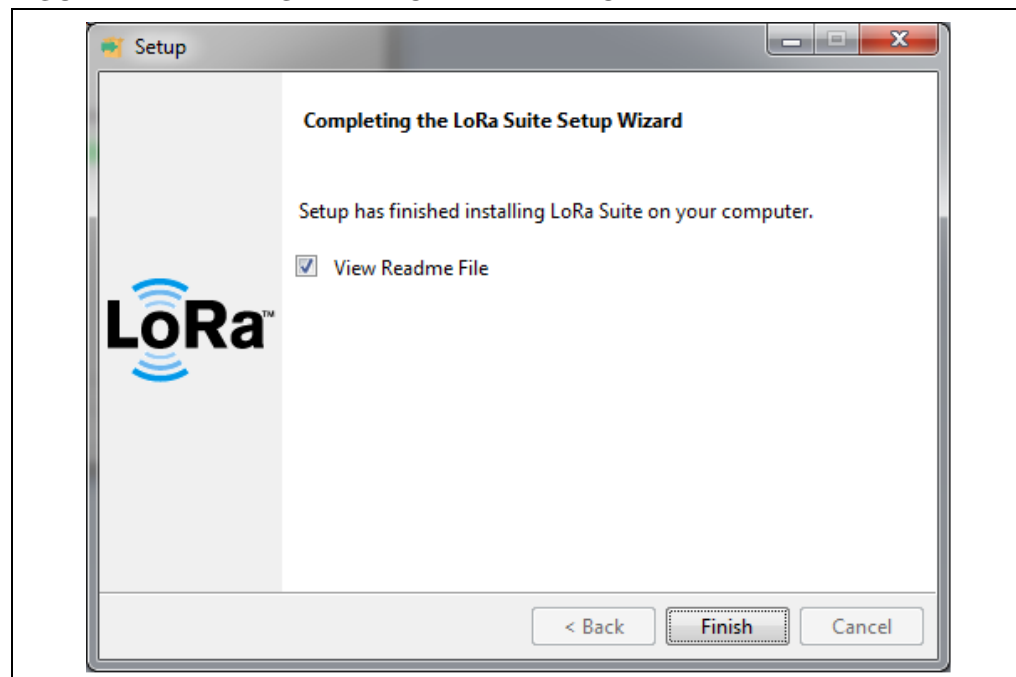
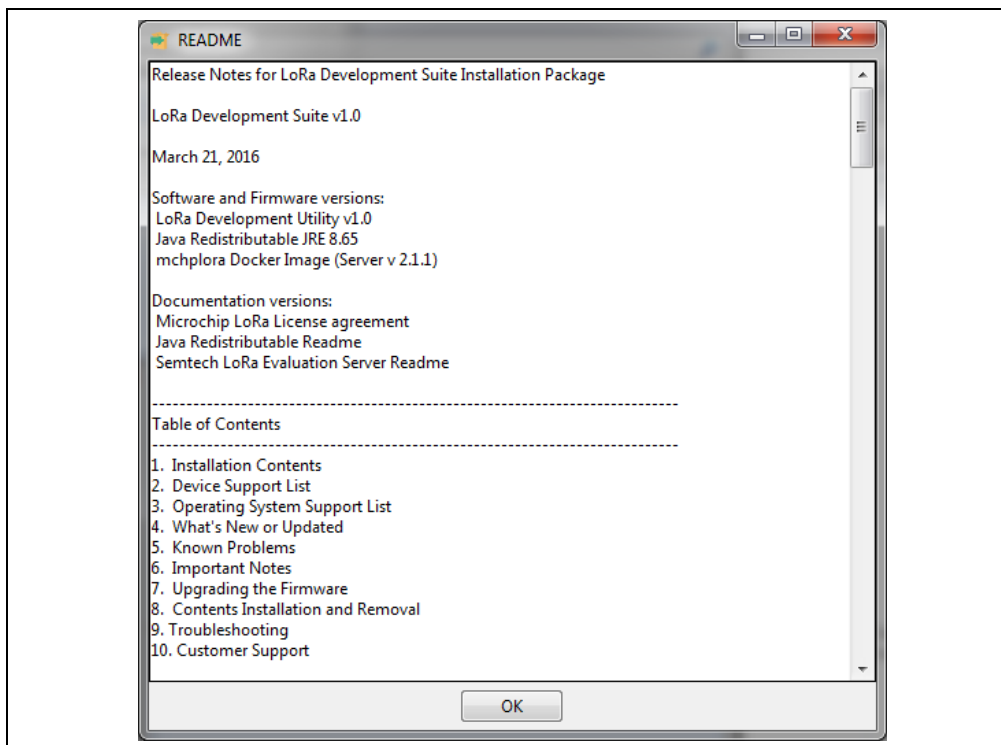
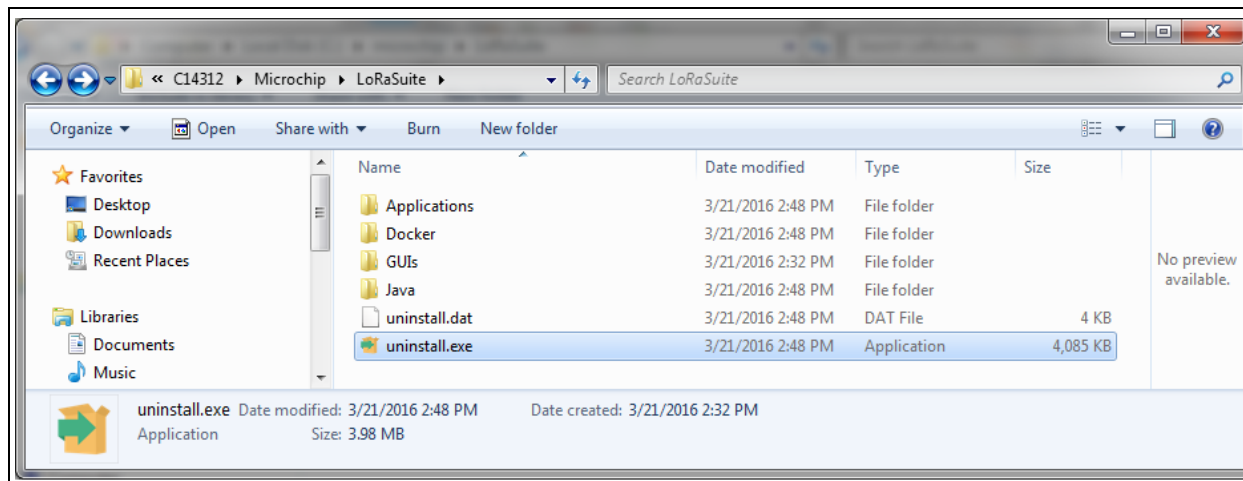

FIGURE 2-8: INSTALLER README



Contents of the installation can be found in the specified directory, and a folder will be added to the Start menu, see [Figure 2-9](#).

FIGURE 2-9: UNINSTALLER



2.3.4 Uninstallation

Execution of the Uninstaller will completely remove all contents unpackaged during the installation process at the specified directory. The Uninstaller will not remove any additional material loaded on the user's computer, including those installed by the redistributors. A single prompt message will appear, confirming the desire to uninstall the LoRa Technology Development Suite and all of its modules, see [Figure 2-10](#).

FIGURE 2-10: CONFIRM UNINSTALL

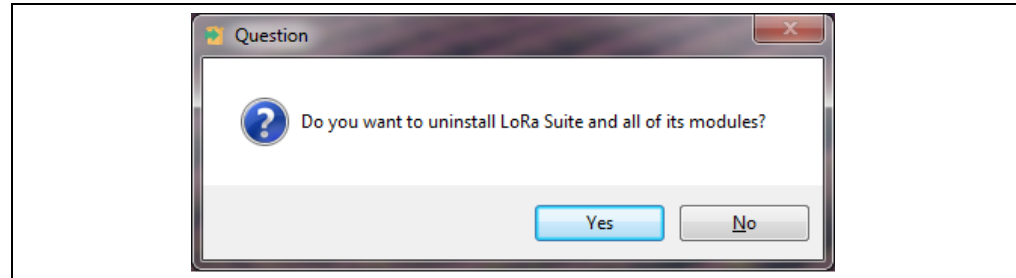

Once confirmed, it will take a short amount of time to remove the contents. A progress bar is used to indicate the status. After completion a pop-up box will appear indicating the uninstallation is completed, see [Figure 2-11](#).

FIGURE 2-11: UNINSTALL COMPLETION

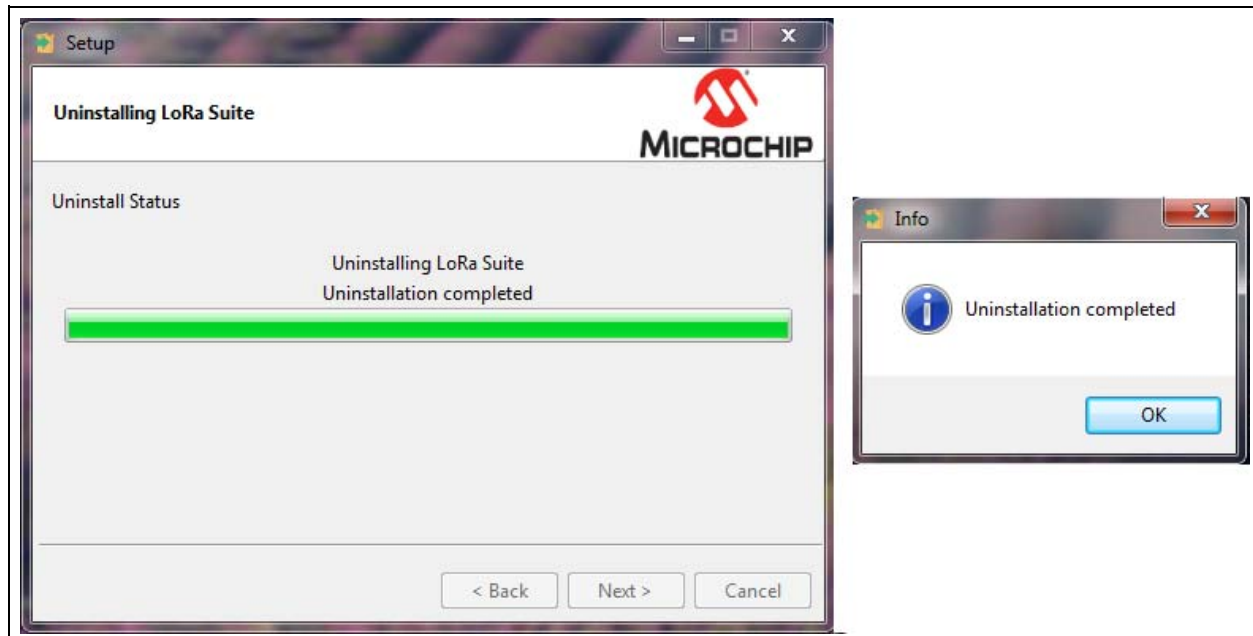

2.3.5 Installing Java Redistributable RE8

Java 8 is required to be installed on the PC for use of the Development Utility. Included with the suite is a copy of the Java Runtime RE8 redistributable (64-bit); it can be found in the installation directory within the *Java* folder. Start the installation by executing the *jre-8u65-windows-x64.exe* (Windows), *jre-8u65-macosx-x64.dmg* (MAC), *jre-8u65-linux-x64.rpm* (Linux).

The installer may ask security permission to run, followed by the Welcome screen (see [Figure 2-12](#)). From the Welcome screen the installation can begin, or a custom installation destination folder can be specified ([Figure 2-13](#)).

FIGURE 2-12: JAVA™ SETUP WELCOME



FIGURE 2-13: JAVA™ INSTALLATION DIRECTORY

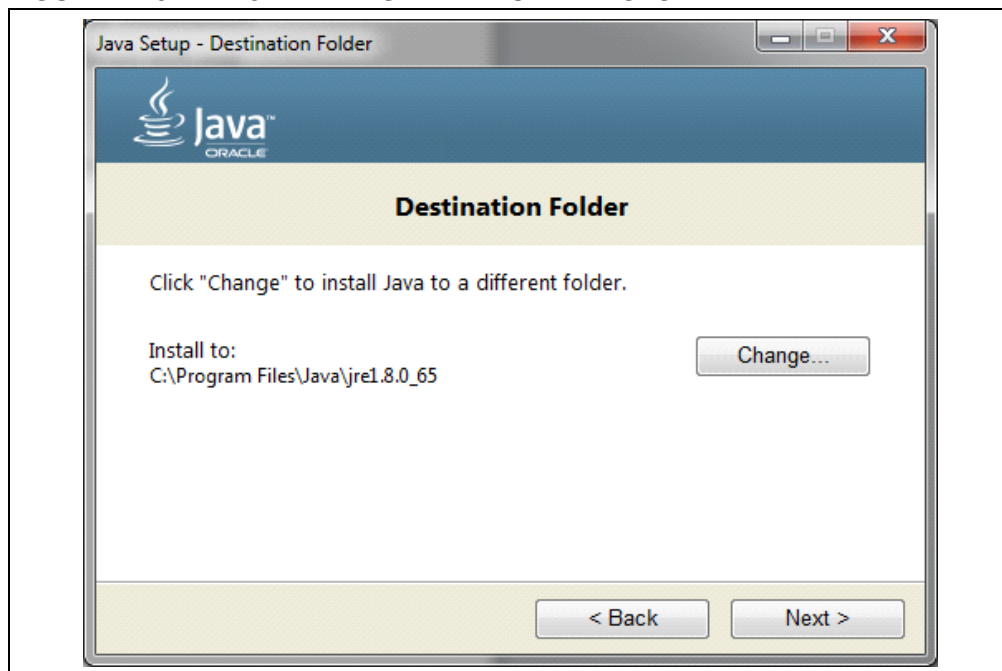

The installation of the Java Runtime Environment 8.65 by Oracle will take a short time (see [Figure 2-14](#)).

FIGURE 2-14: JAVA™ INSTALLATION



If a previous version of Java is already installed on the computer, after completion the installer will ask if an uninstallation of old version is required (see [Figure 2-15](#)).

FIGURE 2-15: OUT-OF-DATE UNINSTALLATION



LoRa[®] Technology Evaluation Suite User's Guide

Completion of the Java 8 installation will bring up a final prompt window (see [Figure 2-16](#)).

FIGURE 2-16: JAVA™ INSTALLATION COMPLETION



2.3.6 Installing Docker Toolbox

Installation of the Docker Toolbox application is required for use of running the evaluation servers included with the suite. Go to the website <https://www.docker.com/products/docker-toolbox> to download a copy.

It is recommended to follow the Docker Toolbox Get Started Process.

- Windows: <https://docs.docker.com/windows/>
- Mac: <https://docs.docker.com/mac/>
- Linux: <https://docs.docker.com/linux/>

The installer may ask security permission to run, followed by the Setup screen (see [Figure 2-17](#)). It is recommended that a full installation is done, however a custom installation can be performed. The use of Kinematic and Git are not required.

FIGURE 2-17: DOCKER™ TOOLBOX SETUP

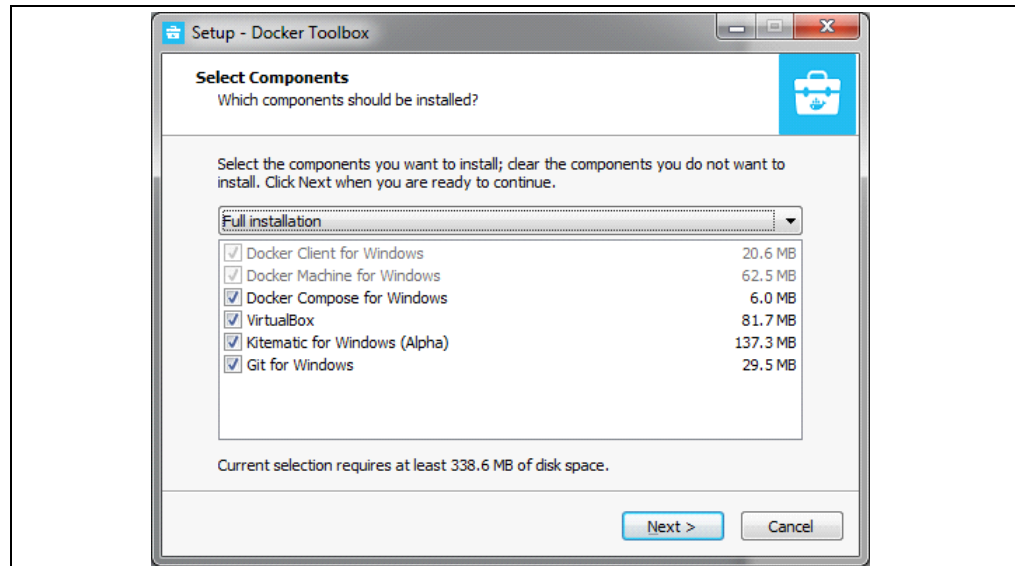

Before installation can complete, the Docker Toolbox will request a final configuration request (see [Figure 2-18](#)). It is recommended to check **Add docker binaries to PATH**, as well as **Upgrade Boot2Docker VM**, for best experience.

FIGURE 2-18: ADDITIONAL TASK

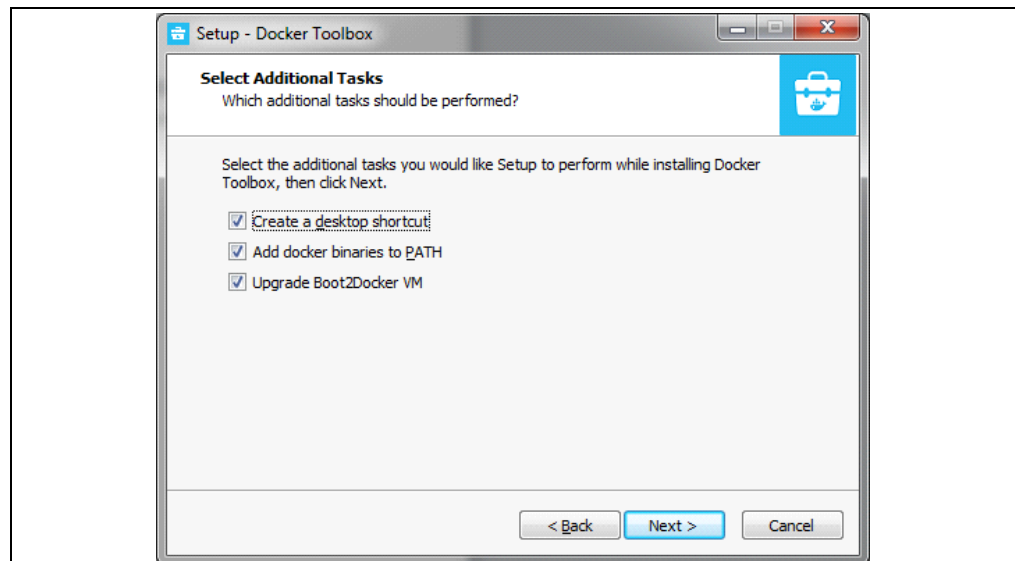

LoRa[®] Technology Evaluation Suite User's Guide

A final review of the installation description is given prior to installation execution (see [Figure 2-19](#)).

FIGURE 2-19: SUMMARY

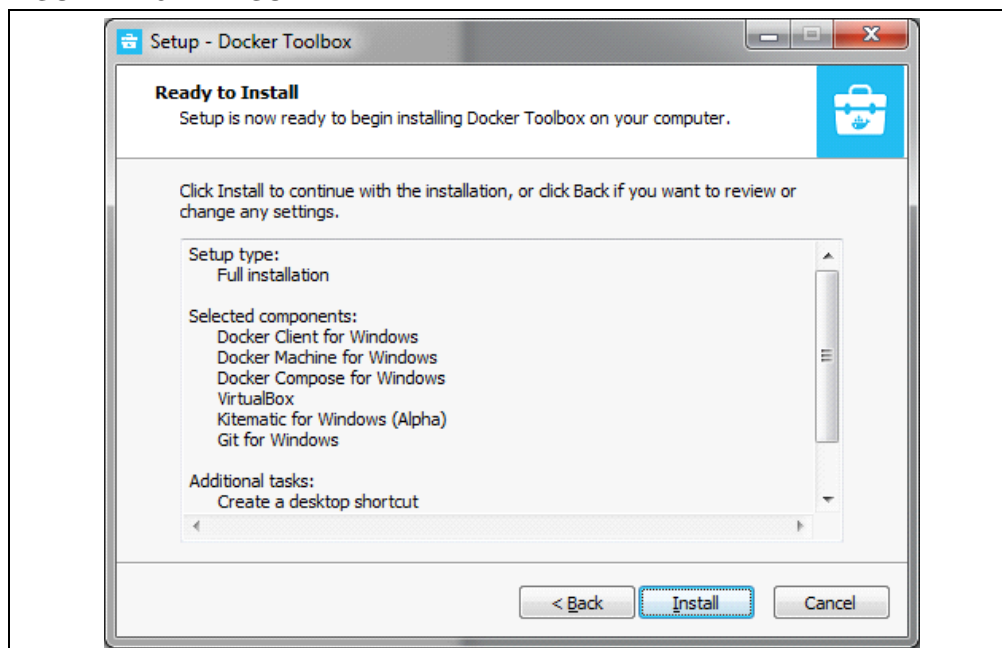

The Docker Toolbox will take a short time. The desired installation directory cannot be specified (see [Figure 2-20](#)).

FIGURE 2-20: TOOLBOX INSTALLATION

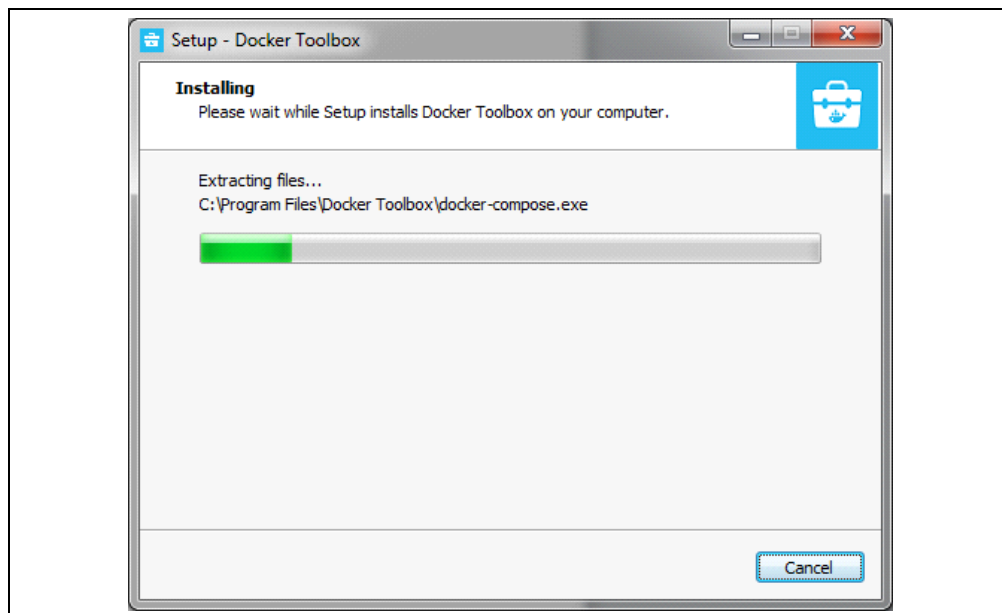

Upon successful installation, the prompt window will request if shortcuts should be shown upon completion (see [Figure 2-21](#)).

FIGURE 2-21: INSTALLATION COMPLETION

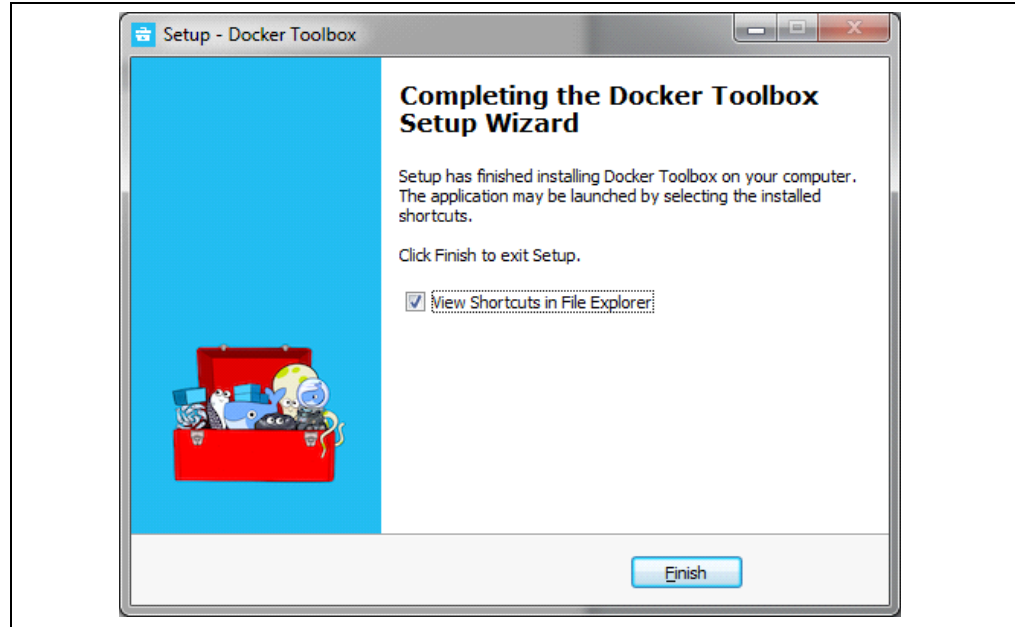

LoRa[®] Technology Evaluation Suite User's Guide

NOTES:

Chapter 3. System Preparation

3.1 LAUNCH ORACLE VM VIRTUALBOX

Purpose

Oracle VM VirtualBox runs the Docker Engine, which is required for server operation.

Objectives

- Execute Oracle VM VirtualBox Manager ([Figure 3-1](#))

FIGURE 3-1: ORACLE[®] VM VIRTUALBOX MANAGER

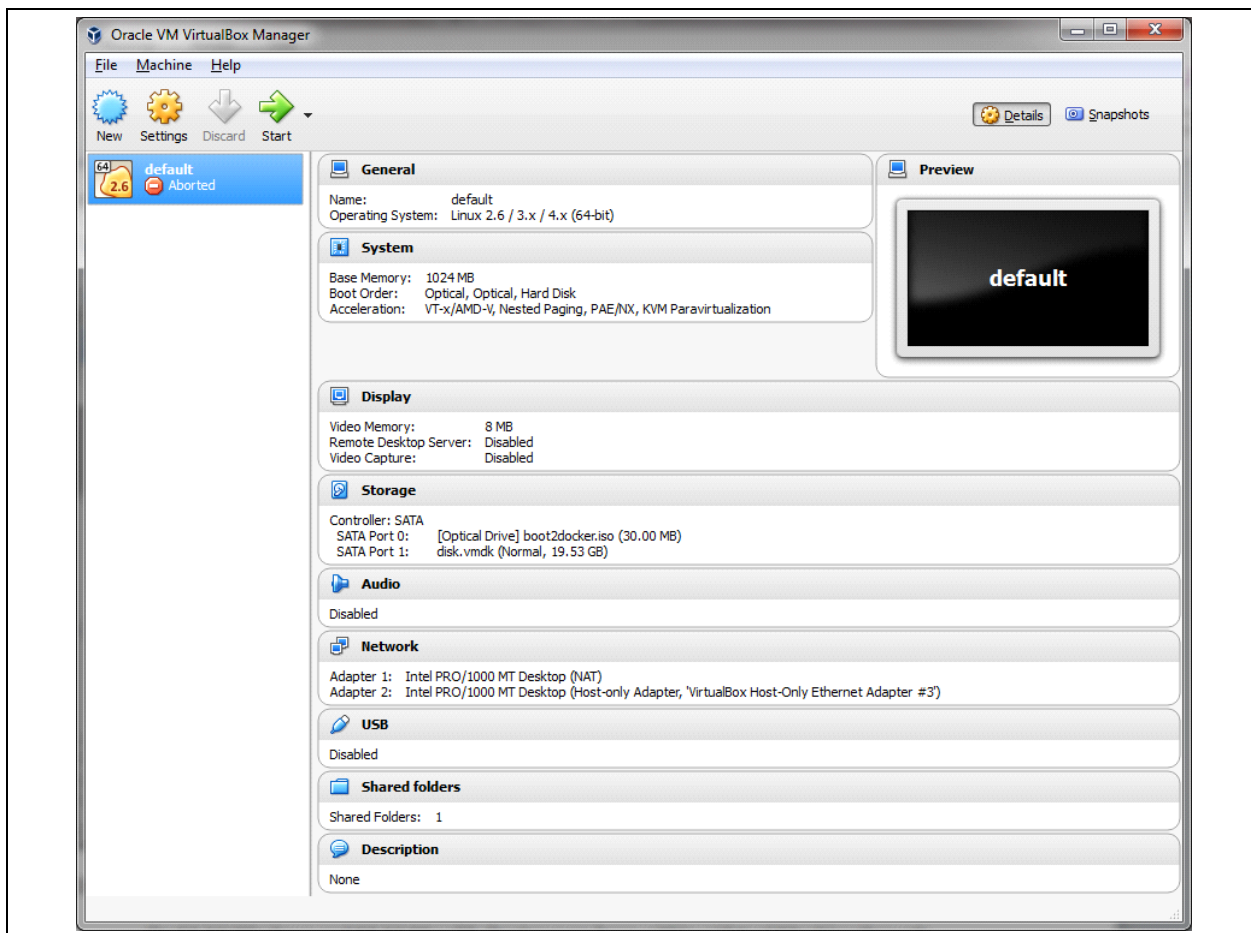

Description

On 64-bit Windows and 64-bit Mac OS, Docker runs from within a Virtual Machine through Oracle VirtualBox, which is installed along with the Docker Toolbox; Docker runs natively on 64-bit Linux systems. For Windows and MAC it will also be necessary to forward Port traffic settings. This can be done using the Oracle VM VirtualBox Manager tool. [Figure 3-1](#) shows what this may look like after a clean installation.

3.2 ADD PORT FORWARDING RULES FOR ORACLE VM VIRTUALBOX MANAGER

Purpose

This allows the PC to forward all Gateway and Database Traffic to the **default** virtual machine where the evaluation Server/Database is running.

Objectives

- Select **default** virtual machine from available list (Figure 3-2)

FIGURE 3-2: DEFAULT VIRTUAL MACHINE

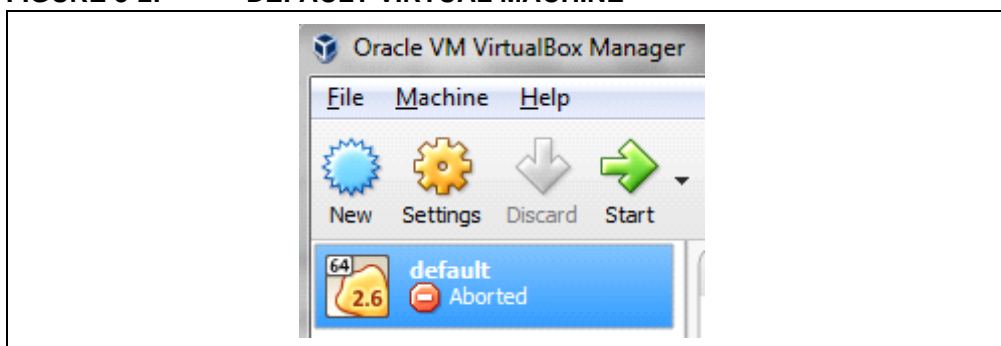

- Go to **Settings** (Figure 3-3)

FIGURE 3-3: VIRTUAL MACHINE SETTINGS

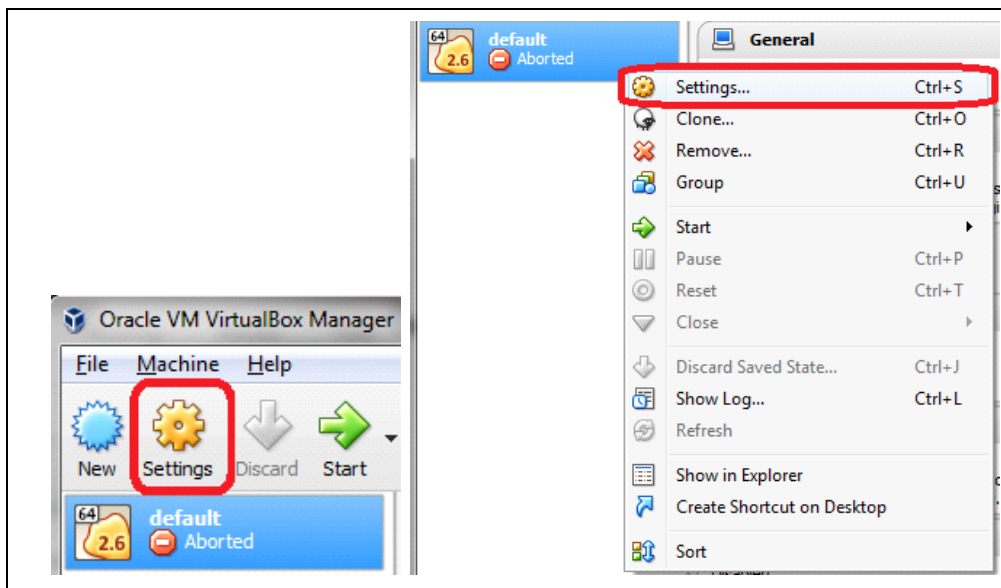

- Select **Network** (see [Figure 3-4](#))

FIGURE 3-4: NETWORK TAB

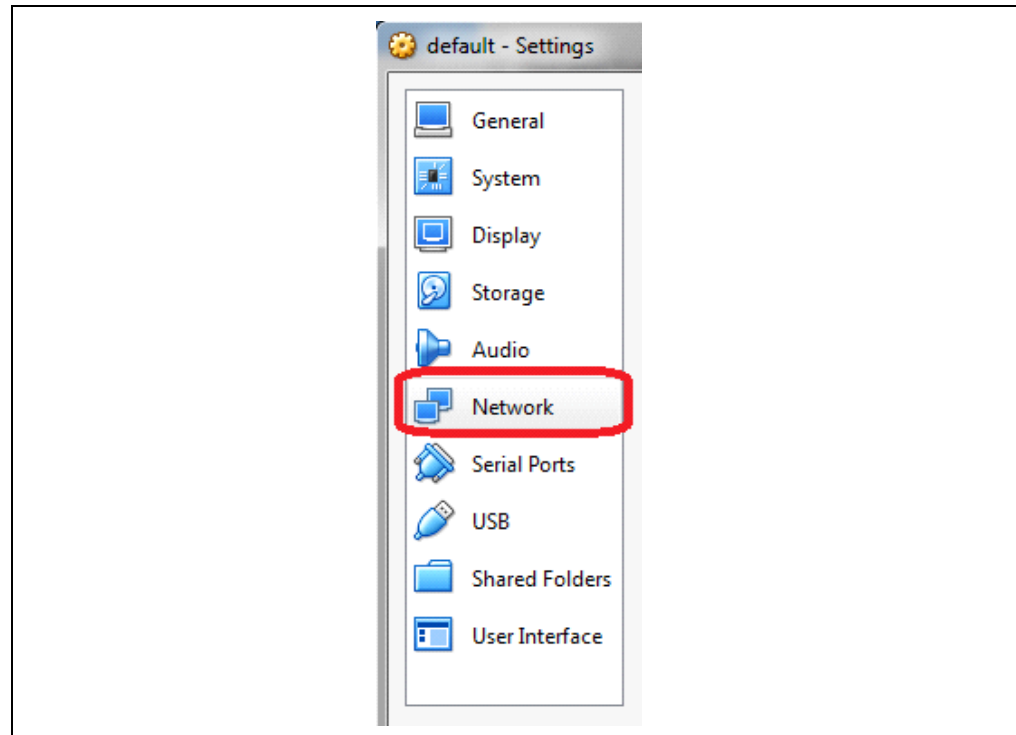

- Press **Port Forwarding** button (see [Figure 3-5](#))

FIGURE 3-5: NETWORK ADVANCED SETTINGS

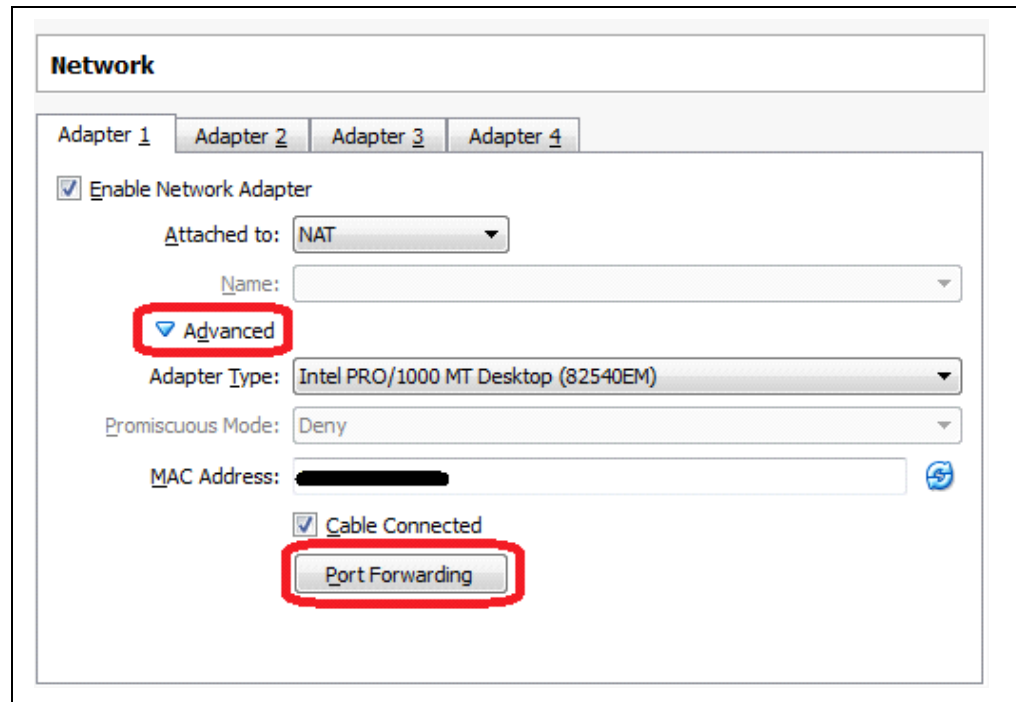

LoRa[®] Technology Evaluation Suite User's Guide

- Press icon to Add Port Forwarding Rule (Figure 3-6)
- Create first Rule as described below (Figure 3-6):
 - Name: Gateway Traffic
 - Protocol: UDP
 - Host IP: <Left Intentionally Blank; Allows for forwarding of all traffic>
 - Host Port: 1700
 - Guest IP: <Left Intentionally Blank; Allows for forwarding of all traffic>
 - Guest Port: 1700
- Press icon to Add Port Forwarding Rule (Figure 3-6)
- Create second Rule as described below (Figure 3-6):
 - Name: MySQL Traffic
 - Protocol: TCP
 - Host IP: <Left Intentionally Blank; Allows for forwarding of all traffic>
 - Host Port: 3306
 - Guest IP: <Left Intentionally Blank; Allows for forwarding of all traffic>
 - Guest Port: 3306
- - Press icon to Add Port Forwarding Rule (Figure 3-6)
- - Create third Rule as described below (Figure 3-6):
 - Name: Customer Server Traffic
 - Protocol: UDP
 - Host IP: <Left Intentionally Blank; Allows for forwarding of all traffic>
 - Host Port: 5000
 - Guest IP: <Left Intentionally Blank; Allows for forwarding of all traffic>
 - Guest Port: 5000

FIGURE 3-6: PORT FORWARDING RULES

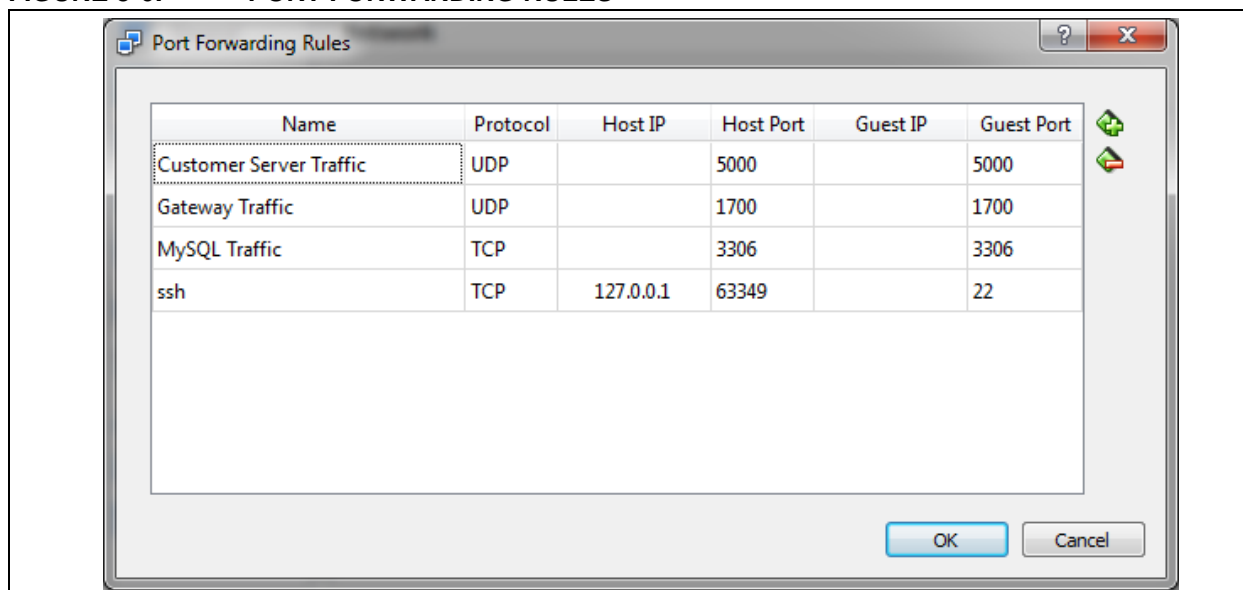

- Close all Oracle VM Virtual Box Windows

Description

Select the default virtual machine and then go to **Settings**. This can be done from the menu at the top, or by right clicking and selecting it. [Figure 3-5](#) shows the locations.

From the **Settings Menu** select the **Network Tab**, next press the **Port Forwarding** push button. This will bring up a Port Forwarding Rules breakout window; two new rules will be created by clicking on the **Add File** icon. The naming does not matter, but should be meaningful for the user.

For our example, name the first rule Gateway Traffic. Leave the Host IP and Guest IP blank, to allow reception of all network traffic. Set the Host Port and Guest Port to 1700. Name the second rule MySQL Traffic. Again, leave the IPs blank; this time set the Ports to 3306. Name the third rule Customer Server Traffic. Again, leave the IPs blank; this time set the Ports to 5000.

3.3 ASSIGN STATIC IP

Purpose

This configures the PC to use a static IP address for it Local Area Network (LAN) Ethernet connection.

Objectives

- Open Control Panel ([Figure 3-7](#))
- Network Status and Task ([Figure 3-7](#))

FIGURE 3-7: CONTROL PANEL

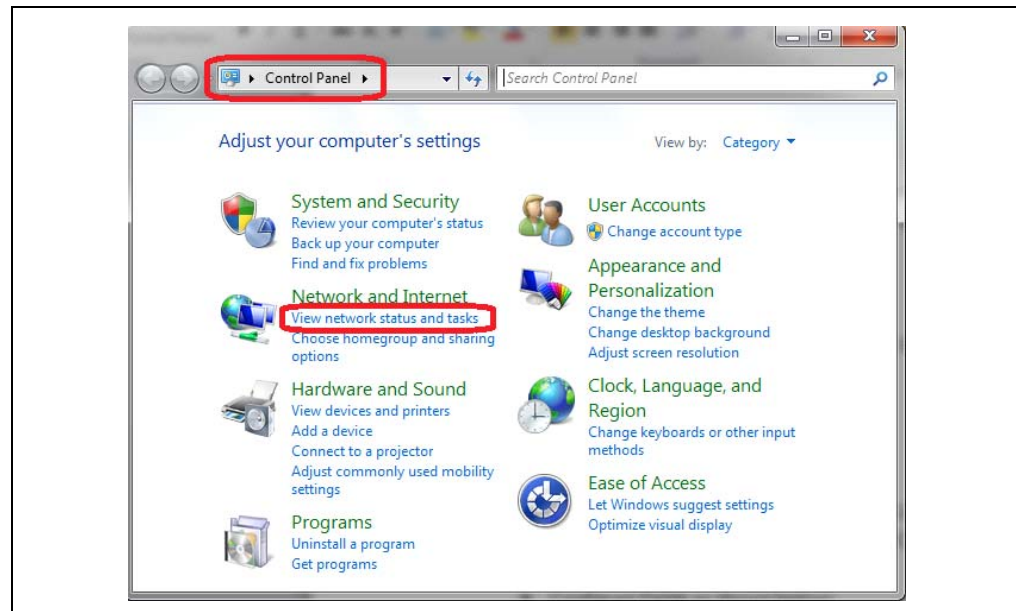

- Change Adaptor Settings (Figure 3-8)

FIGURE 3-8: NETWORK STATUS AND TASKS

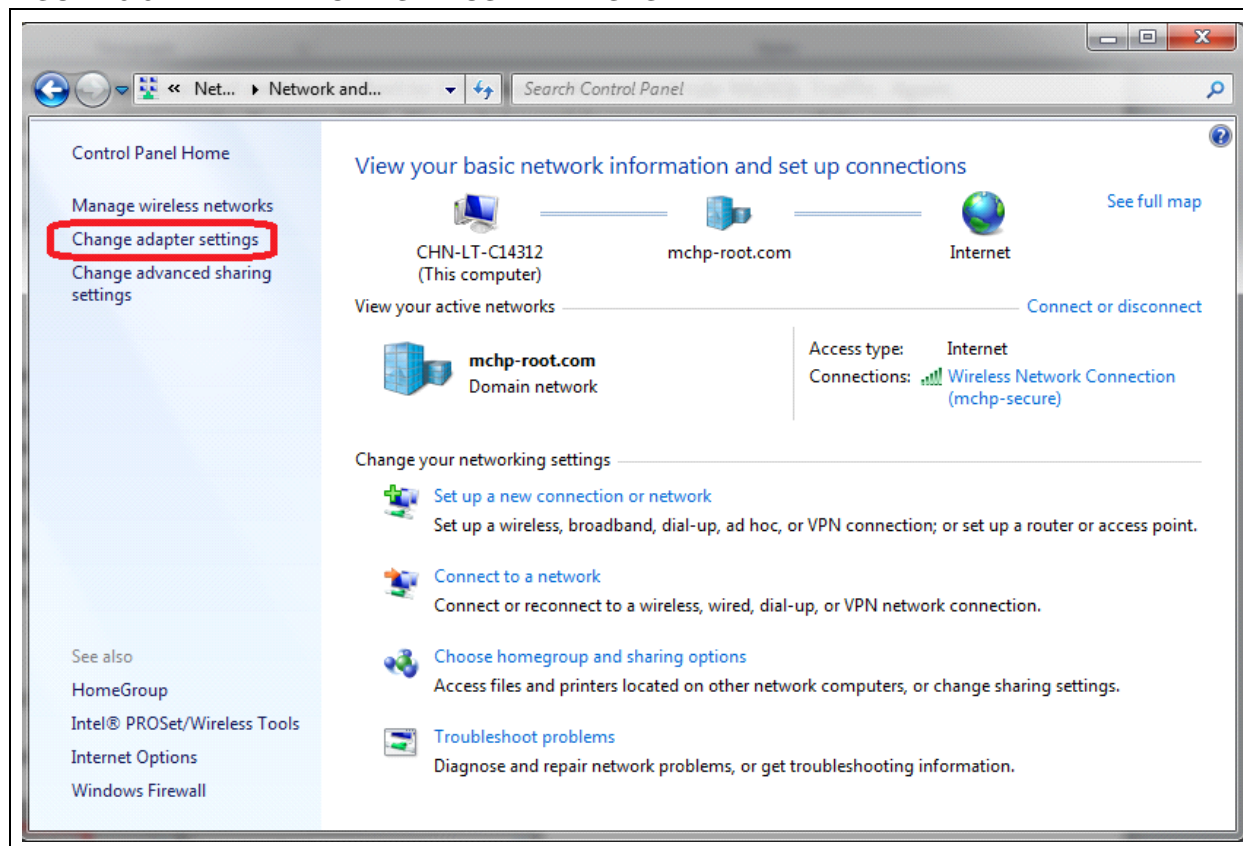

- Configure PC Local Area Network (LAN) Connection Properties (Figure 3-9)

FIGURE 3-9: LOCAL AREA (LAN) CONNECTION

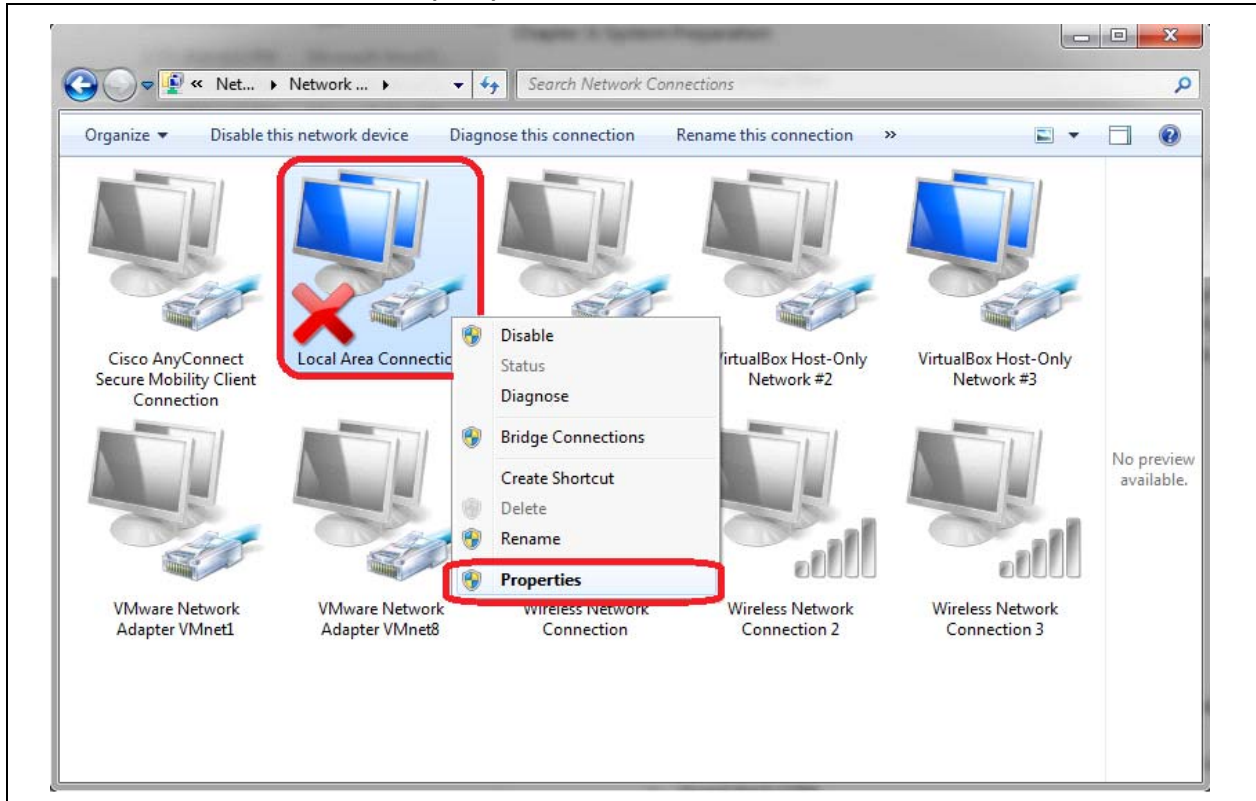

- Configure Internet Protocol Version 4 (TCP/IPv4) Properties (Figure 3-10)

FIGURE 3-10: LAN PROPERTIES

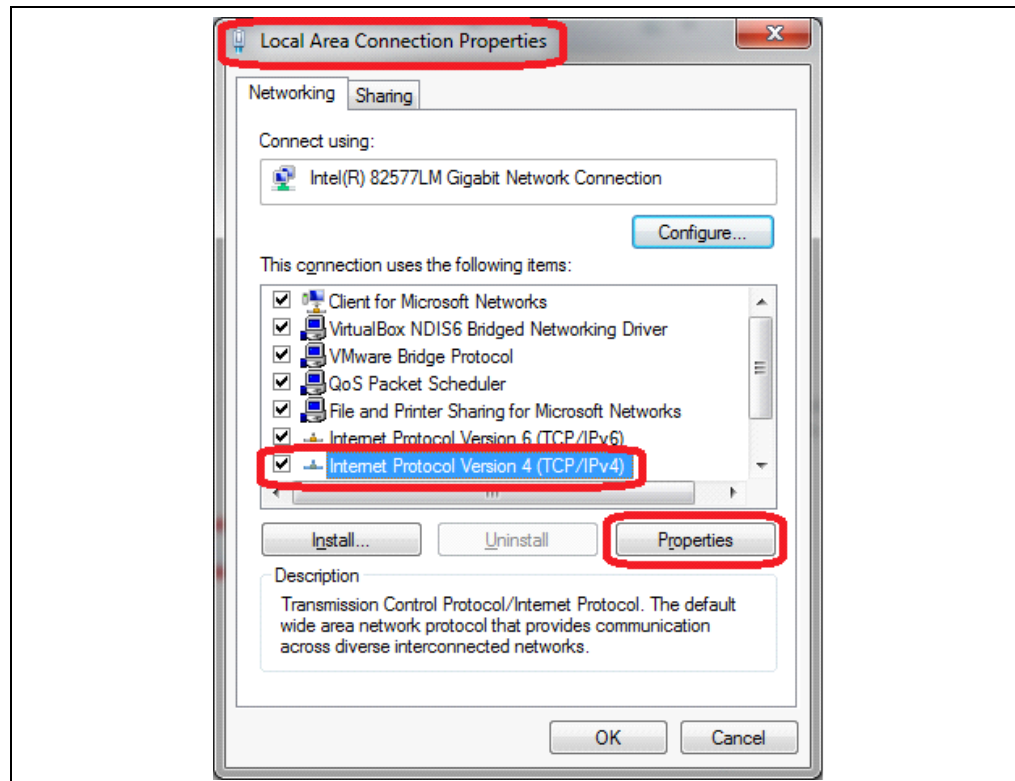

- Select **Use the following Settings** (Figure 3-11)
- Configure fields as shown below (Figure 3-11):
 - IP Address: 192.168.1.1
 - Subnet Mask: 255.255.255.0
- Click **OK** to save settings (Figure 3-11)

FIGURE 3-11: INTERNET PROTOCOL VERSION 4 (TCP/IPV4) PROPERTIES

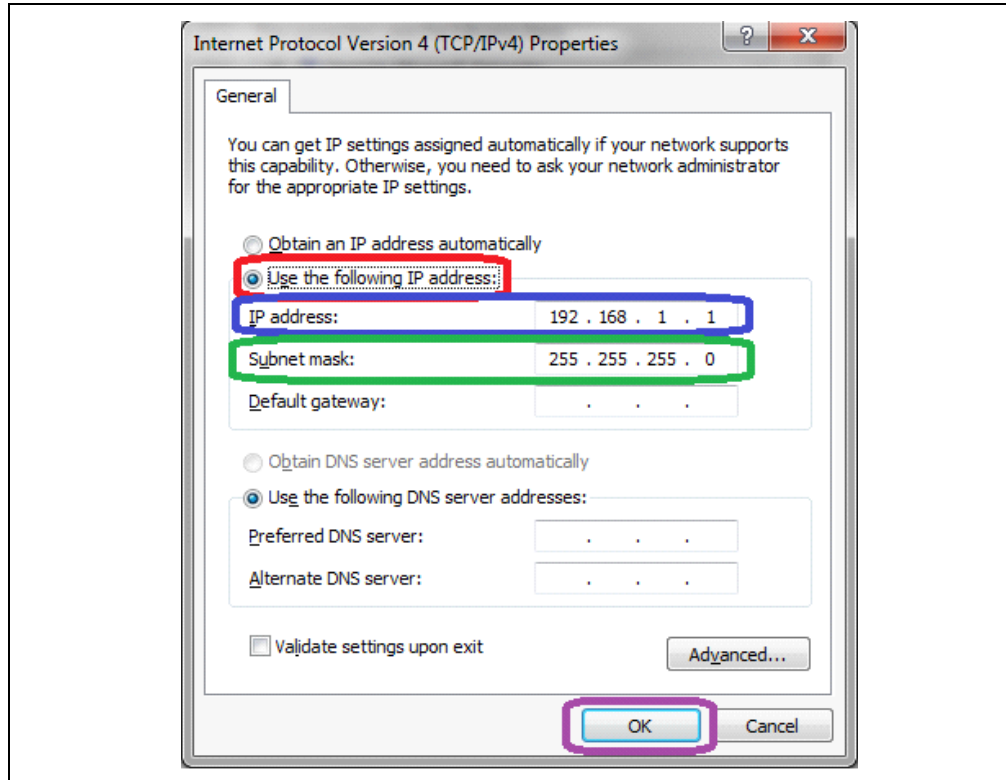

- Exit all other Setting windows

Description

Since the Gateway unit will be connected directly to the Host PC, where the Server container is being run, we must first assign the PC as static IP address. This can be done by going to the network settings.

For Windows, go to the **Control Panel**. Under **Network and Internet** is **View network status and tasks**, as seen in Figure 3-7.

From the **Network and Internet** display, select **Change adapter settings** (Figure 3-8) to bring up available network connections (Figure 3-9).

From the available connections, find **Local Area Connection**, right click and go to properties. Navigate the scroll bar inside the properties window and find **Internet Protocol Version 4 (TCP/IPv4)** and select properties (see Figure 3-10).

Inside the **Internet Protocol Version 4 (TCP/IPv4) Properties** settings (Figure 3-11), select **Use the following IP address**. Make the IP Address match that used by the Server IP used by the Gateway. By default this value is: 192.168.1.1. Assign a Subnet Mask; by default this is: 255.255.255.0.

4.3 VIEW DOCKER IMAGE

Purpose

This command will show all current Image Repositories and details.

Objectives

- Execute Docker Command (Figure 4-4)

Command

- `docker images`

FIGURE 4-4: VIEW IMAGE REPOSITORY INFORMATION



```
MINGW64:/c/Users/C14312
C14312@CHN-LT-C14312 MINGW64 ~
$ docker images
REPOSITORY          TAG          IMAGE ID          CREATED
mchplora            1.1         sha256:fb211     3 weeks ago
341 MB
```

Description

Once the image has been loaded it will become available to the user through Docker as a container. Review of available containers can be seen using the Image command.

Figure 4-4 shows this process in Docker.

4.4 CREATE DOCKER CONTAINER

Purpose

By issuing this command, the Container 'lora_server' is made using the Repository Image 'mchplora', Tag version 1.1. This Container has an open UP/DOWN Port of 1700 for UDP traffic, and 3306 for TCP traffic.

Objectives

- Execute Docker Command (Figure 4-5)

Command

- `docker create --name lora_server -p 1700:1700/UDP -p 3306:3306/TCP -p 5000:5000/UDP mchplora:1.1`

Format

- `docker create --name <Container Name> -p <UP:DOWN Ports>/<Communication Type> <Image>:<Tag Version>`

FIGURE 4-5: CREATE CONTAINER FROM IMAGE

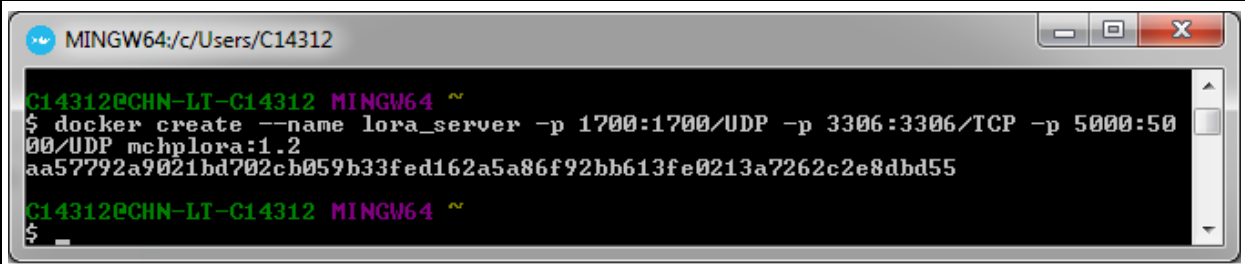

```
MINGW64:/c/Users/C14312
C14312@CHN-LT-C14312 MINGW64 ~
$ docker create --name lora_server -p 1700:1700/UDP -p 3306:3306/TCP -p 5000:5000/UDP mchplora:1.2
aa57792a9021bd702cb059b33fed162a5a86f92bb613fe0213a7262c2e8dbd55
C14312@CHN-LT-C14312 MINGW64 ~
$
```

Description

With the image available to Docker, it is now ready for a container to be created. Again, this can be done through Docker, using the `docker create` command. This will create the container with specific information for future use. It may take a small amount of time for the container to be created. Once done, a Hex string representing the Image ID will be displayed. [Figure 4-5](#) shows the create command in use.

4.5 START CONTAINER

Purpose

By issuing this command, the Docker Container will begin to run.

Objectives

- Execute Docker Command ([Figure 4-6](#))

Command

- `docker start lora_server`

Format

- `docker start [Container]`

FIGURE 4-6: CONTAINER START



```
C14312@CHN-LT-C14312 MINGW64 ~  
$ docker start lora_server  
lora_server
```

Description

Once the container is created, the server is able to be started through a simple Docker command. The Container will continue to run, even if Docker Terminal and Oracle VM Virtual Machine windows are closed.

4.6 STOP CONTAINER

Purpose

By issuing this command, the Docker Container will stop running.

Objectives

- Execute Docker Command ([Figure 4-7](#))

Command

- `docker stop lora_server`

Format

- `docker stop [Container]`

FIGURE 4-7: CONTAINER STOP

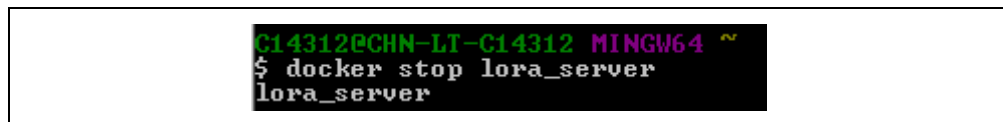

```
C14312@CHN-LT-C14312 MINGW64 ~  
$ docker stop lora_server  
lora_server
```

Description

Once the container is created, the server is able to be started through a simple Docker command. This command, or computer shutdown are the only ways to end a Container operation.

4.7 RESTART CONTAINER

Purpose

By issuing this command, the Docker Container will stop running, and then begin to run again. If the container is not currently running, this command will start it.

Objectives

- Execute Docker Command (Figure 4-8)

Command

- `docker restart lora_server`

Format

- `docker restart [Container]`

FIGURE 4-8: CONTAINER RESTART

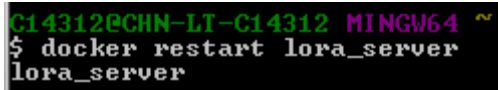

```
C14312@CHN-LT-C14312 MINGW64 ~  
$ docker restart lora_server  
lora_server
```

Description

Once the container is created, the server is able to be started through a simple Docker command. It is sometime necessary to restart the evaluation server to allow completion of configuration, or database additions.

4.8 DOCKER DOCUMENTATION

Purpose

Expand Docker knowledge past the scope that is required for this exercise.

Objectives

- Visit: <https://docs.docker.com/>

Description

This is the extent of interaction with Docker required for this chapter. For additional information on Docker, its commands, and other advanced uses, refer to the official documentation on the program website: www.docker.com.

LoRa[®] Technology Evaluation Suite User's Guide

NOTES:

Chapter 5. Network Evaluation Kit Setup

5.1 CONNECT LoRa TECHNOLOGY DEVICES

Purpose

USB connections are used to power boards, as well as supply Serial Communication for command handling. Ethernet is used for Gateway Traffic with Server.

Objectives:

- Connect Gateway Core board to PC using USB cable (Figure 5-1)
- Connect Gateway Core board to PC LAN Port using Ethernet Cable (Figure 5-1)
- Connect RN Module populated Mote or PICtail to PC using USB cable (Figure 5-1)

FIGURE 5-1: NETWORK EVALUATION KIT

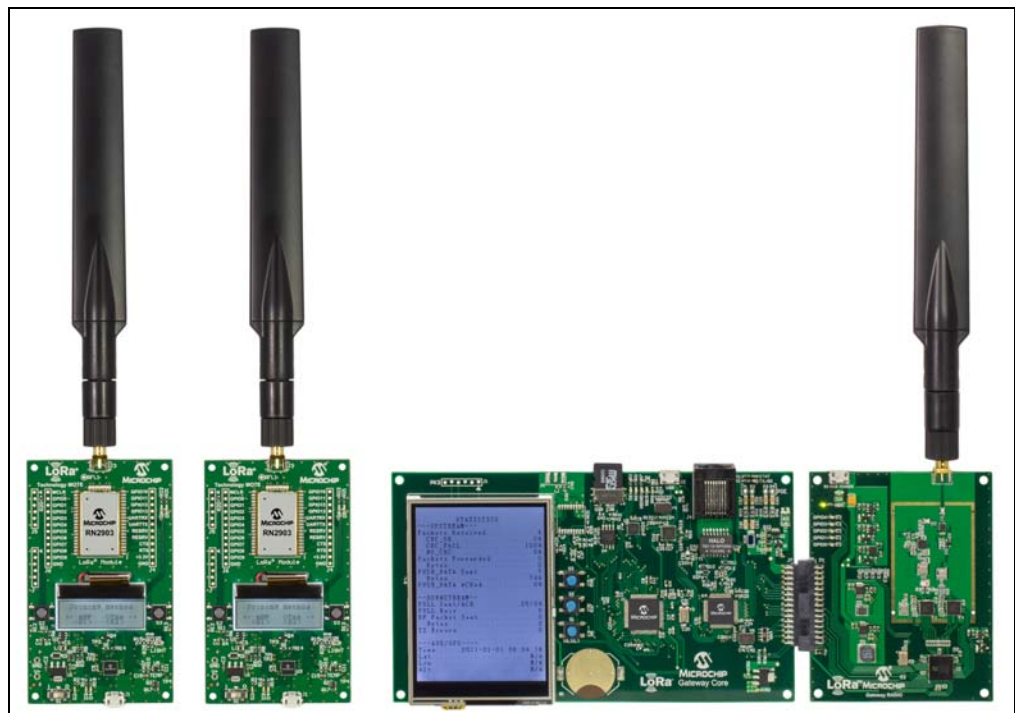

Description

With the LoRa Server container created and started, connect LoRa Network Evaluation Kit boards to the Host PC. The use of the Development Utility will be required for the remaining steps. Once all devices have been connected to the Host PC, launch the Development Utility.

5.2 CONNECT DEVICES TO LoRa DEVELOPMENT UTILITY

Purpose

The Utility is used for demonstration of the LoRa Network Evaluation, making for easy configuration and management of connected Gateway, or RN Module devices.

Objectives

- Launch LoRaDevUtility.jar (Figure 5-2)
- Allow devices to be scanned (Figure 5-2)
- Observe population of the Device List (Figure 5-2)

FIGURE 5-2: CONFIGURATION UTILITY

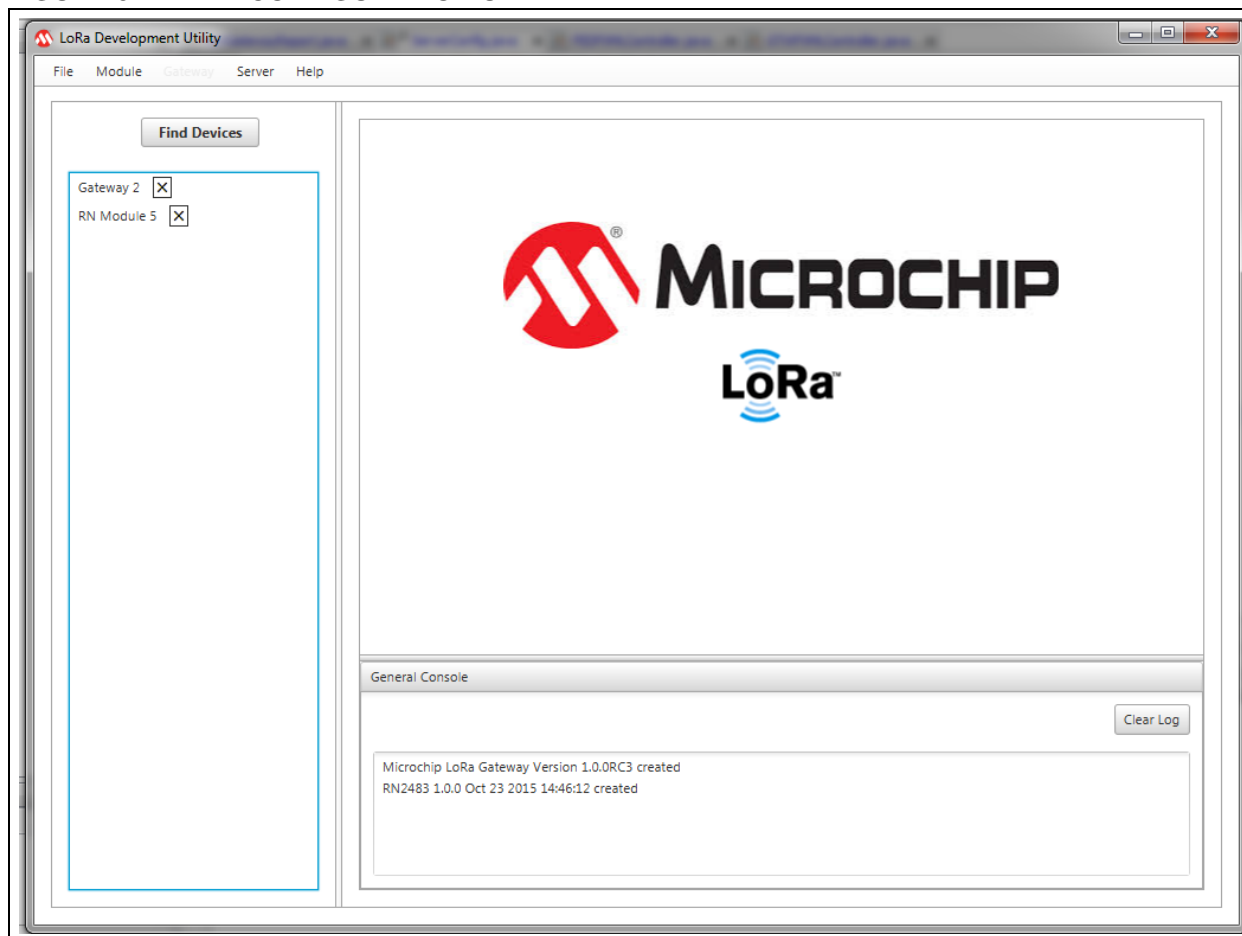

Description

Upon launch, the utility will scan for available LoRa devices. It will do so by first finding available Serial COM ports, then issuing the `sys get ver` command. If either a RN Module or Gateway Core board is connecting, it will respond with its version information. This response is used to determine which type of Device Model will be used by the utility for that designated COM port. If devices are connected after launching the utility, simply press the **Find LoRa Devices** button, and all COM ports will again be scanned. The use of a Gateway and RN Module End Device is required for completion of this chapter. [Figure 5-2](#) shows generally what the utility should look like.

Note: On Windows® computers it is sometimes required to disable COM Port (COM3) to allow for proper communication with the Utility. This can be done through the Device Manager, selecting Ports (COM and LPT); right click on USB Serial Port (COM3) and select Disable.

5.3 CONFIGURE GATEWAY

Purpose

This is used to confirm Factory Programmed Default settings for the Gateway used for this Network Evaluation demonstration. Confirms Communication between Server and Gateway.

Objectives

- Select Gateway from Device List ([Figure 5-3](#))
- Confirm Default Settings ([Figure 5-3](#))
 - Gateway ID: 0x1234567887654321
 - IP Allocation Mode: Static
 - Core Board IP: 192.162.1.101
 - Network Router IP: 192.168.1.1
 - Default Mask IP: 255.255.255.0
 - LoRaWAN Operation: Enabled
 - Forward Valid CRC: Checked (True)
 - Forward Error CRC: Blank (False)
 - Sync Word: 0x34
 - LoRa Server IP: 192.168.1.1
 - Server Up Port: 1700
 - Server Down Port: 1700
 - Keep Alive Interval: 10 (Seconds)
 - Update Interval: 30 (Seconds)
 - Polling Request Rate: 5 (Seconds)
- Start Polling Request ([Figure 5-3](#))
- Observer [Online] Status ([Figure 5-3](#))

FIGURE 5-3: CONFIGURATION UTILITY

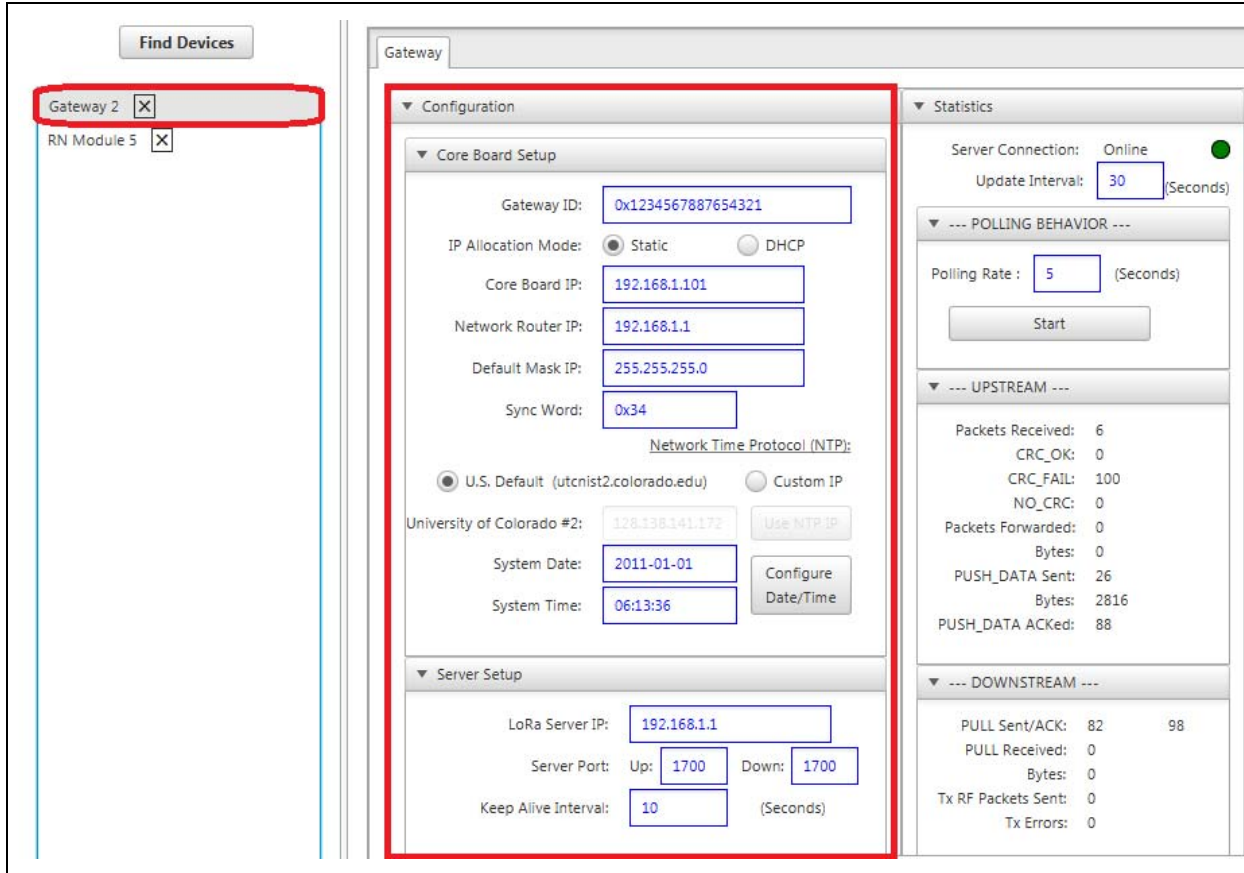

Description

Connect any of Microchip's LoRa Development boards to the PC, using the included USB cables. With the devices connected, browse to launch the LoRa Development Utility as described in [Chapter 1. "Getting Started With The LoRa[®] Suite"](#). After the utility has been launched and the Device List is populated, confirm Gateway settings. Select the Gateway from the utility Device List by clicking on the name. For this chapter's example system, we will be hosting a server locally from our PC at a Static IP Address. The following settings for the Microchip LoRa Gateway board represent the default parameter values, programmed at factory. It is recommended for this exercise to use these values; with different values after completion of this chapter. The Ethernet cable provided with the evaluation kit should be connected to the PC. With the cable connected, and the server IP Address entered as 192.168.1.1, the user should be able to observe an [Online] indicator on the LoRa Gateway LCD display. [Figure 5-3](#) shows these values displayed in the LoRa Development Utility.

5.4 CONFIGURE RN MODULE FOR AUTO-CREATE PERSONALIZATION

Purpose

This will allow for instant acceptance to the evaluation server.

Objectives

- Select RN Module from Device List ([Figure 5-4](#))
- Select **LoRaWAN** Tab ([Figure 5-4](#))
- Press **Auto-Create Personalization** push button ([Figure 5-4](#))

Network Evaluation Kit Setup

FIGURE 5-4: CONFIGURE RN MODULE FOR AUTO-CREATE

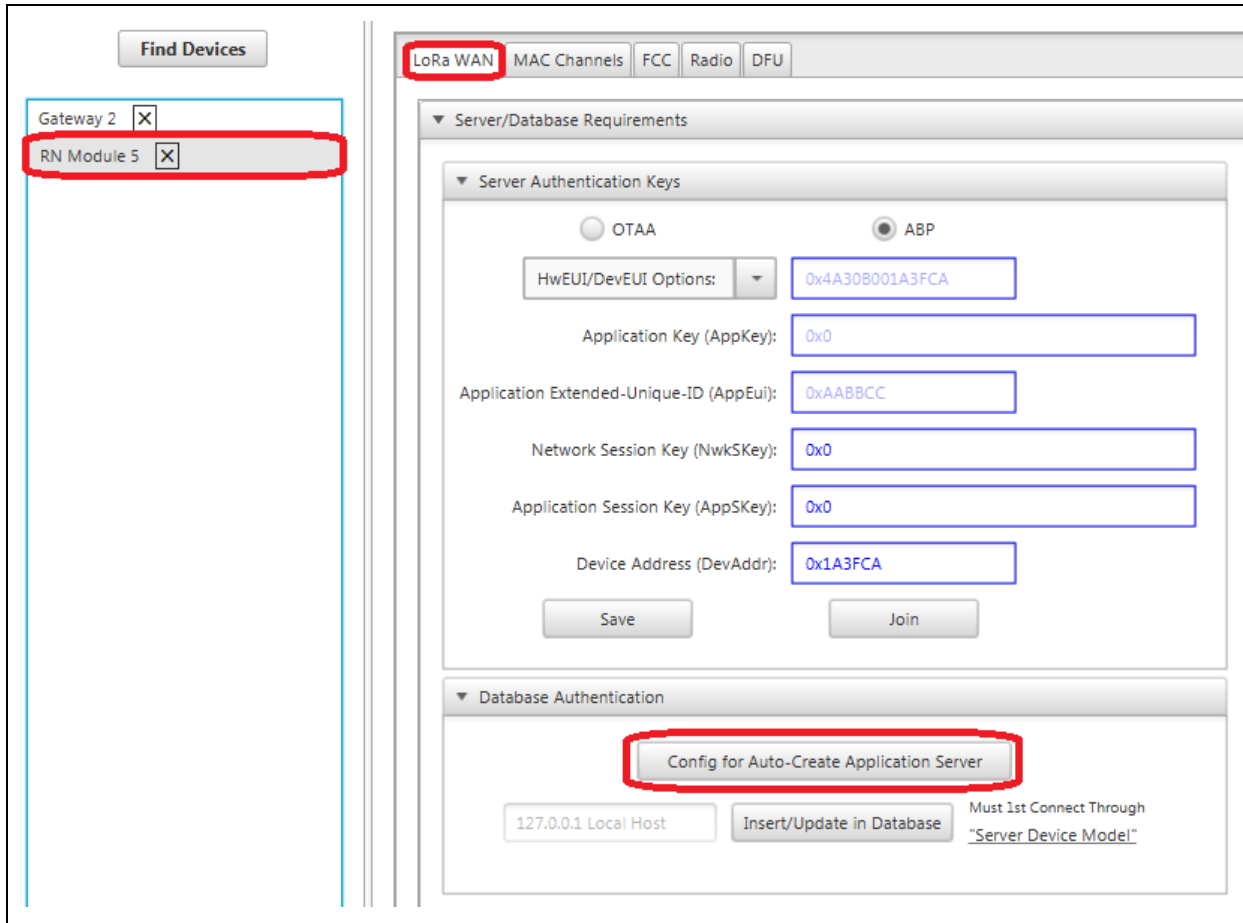

- Observer configuration of parameters (Figure 5-5)

FIGURE 5-5: AUTOMATIC KEY ASSIGNMENT

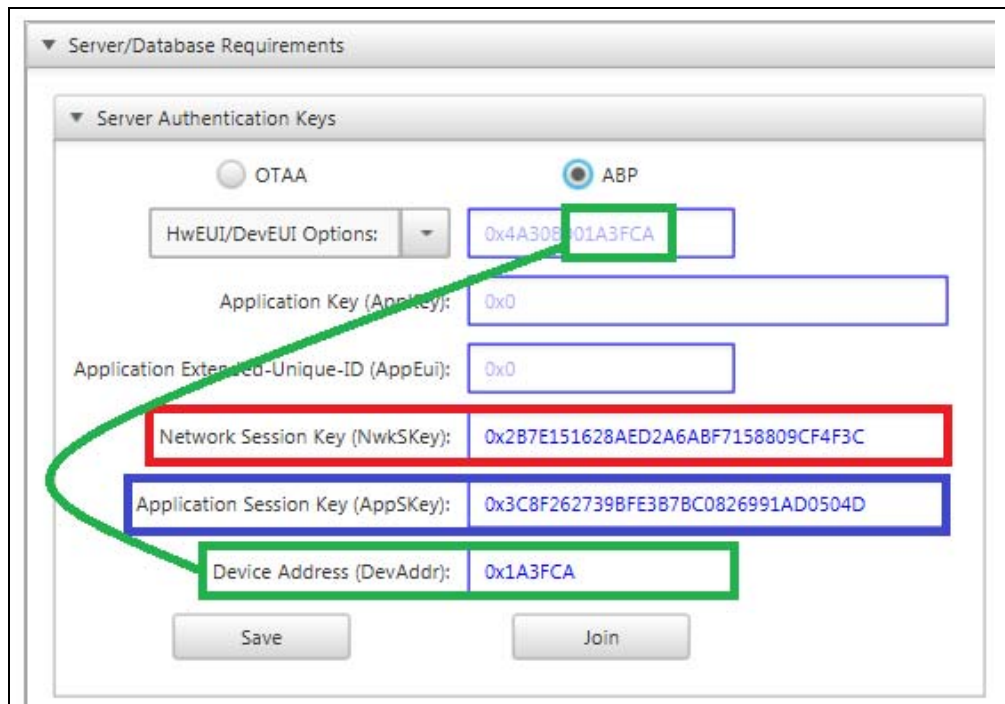

Description

With the LoRa Gateway connected to the Docker-run server, it is time to issue an Uplink Message. Selecting the RN Module from the Device List, it will first connect to the LoRaWAN network using the Auto-Create form of personalization. Under the initial tab for the RN Module, LoRaWAN protocol, the user should select the **ABP** radio button prior to pressing the **Configure for Auto-Create Server** button inside the **Database Authentication** titled pane. This push button will preconfigure the device with specific Network Session Key (0x2B7E151628A6ABF7158809CF4F3C), and Application Session Key (0x3C8F262739BFE3B7BC0826991AD0504D) which have been configured in the server to allow instant access. The Device Address will automatically be filled in, using the lower eight bytes of the Hardware Extended-Unique-Identifier (HwEUI). The module will automatically issue a **SAVE**, and **JOIN** command upon button press.

This will configure Network Session Key as 0x2B7E151628A6ABF7158809CF4F3C, and Application Session Key as 0x3C8F262739BFE3B7BC0826991AD0504D. These credentials are used to grant instant access to the Server Network. Device Address is generated from the RN Module's lower eight bytes of the Hardware Extended-Unique-Identifier (HwEUI).

5.5 ADD SERVER TO DEVICE LIST

Purpose

This populates a Server instance to the Device List.

Objectives

- Select **Server** from Utility menu (Figure 5-6)
- Select **Add** under Server menu (Figure 5-6)

FIGURE 5-6: ADD SERVER

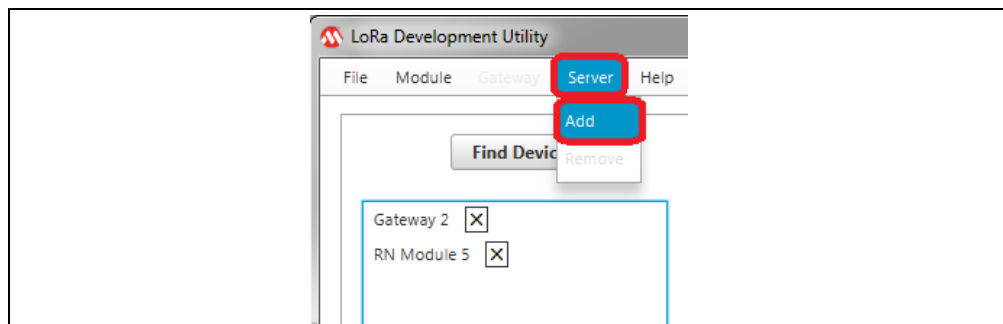

- Observe Server added to Device List (Figure 5-7)

FIGURE 5-7: SERVER IN DEVICE LIST

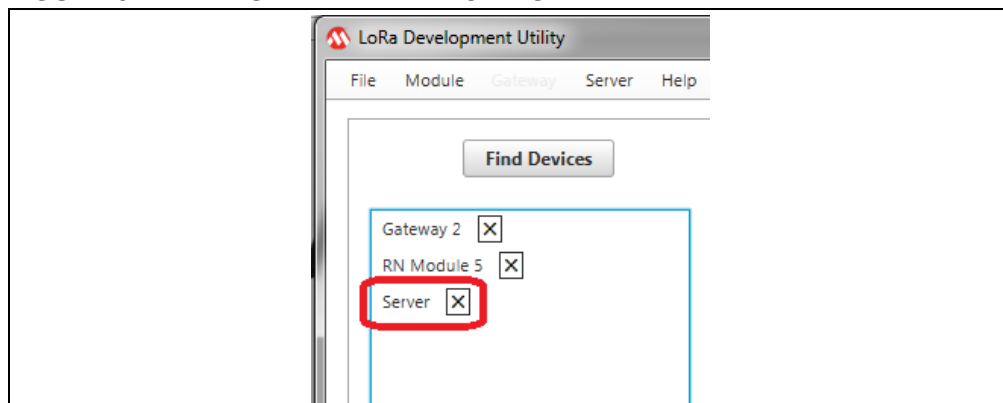

Description

With the Uplink Message successfully issued by the End Device, it is time to check and see if the Server has successfully captured the transmission. This can be done using the LoRa Development Utility Server Device Model view. To populate the Server Device Model to the list, go to the top menu, click on **Server** and then add. This will add a Server device to the Device List column, as shown in [Figure 5-7](#). There can only be a single server instance created at one time.

5.6 CONNECT UTILITY TO MySQL IP ADDRESS

Purpose

This connects the Utility to the MySQL database used with to manage evaluation server data.

Objectives

- Enter 192.168.1.1 into MySQL IP Address text field ([Figure 5-8](#))

FIGURE 5-8: SUCCESSFUL CONNECTION

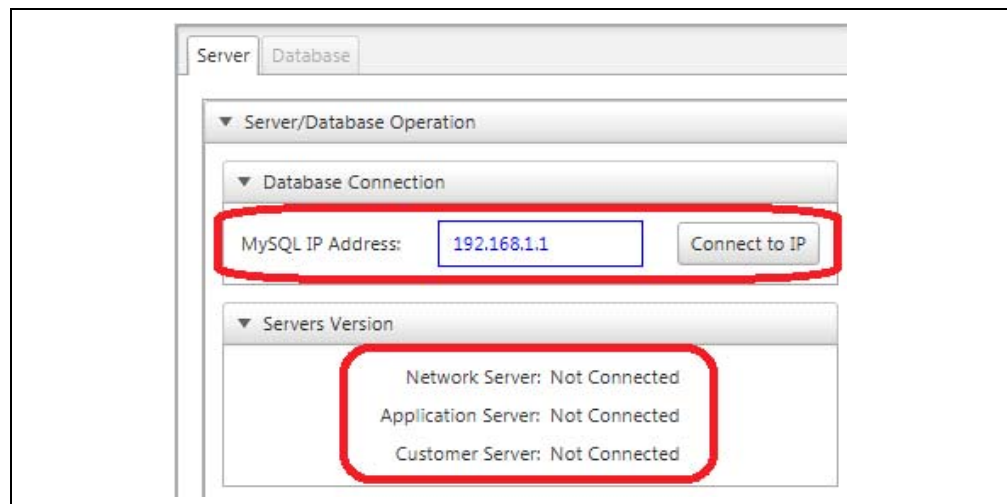

- Confirm Connection Status ([Figure 5-9](#))

FIGURE 5-9: SUCCESSFUL CONNECTION

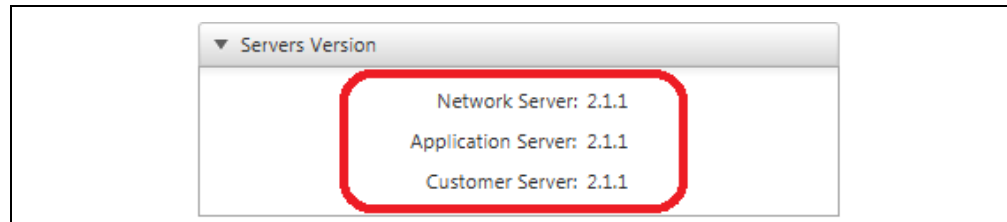

Description

From the Server Device Model view, enter the server IP Address into the MySQL IP Address text field. Press Enter on the key board while in the text field, or click on the **Connect to IP** push button to set the value for the model. A timestamp message will appear in the Server Console showing the new MySQL IP.

When not connected to a Server/Database, the Version will show “Not Connected”, as seen in [Figure 5-8](#). Once connected to the IP address, the correct Server Version will be shown, as seen in [Figure 5-9](#).

LoRa[®] Technology Evaluation Suite User's Guide

NOTES:

Chapter 6. Additional Setup for Operation at 915 MHz

6.1 CONFIGURE RN MODULE FOR 8 CHANNELS

Purpose

This will configure the RN Module to only issue LoRaWAN transmission on channels 0-7, which are the only channels supported by the Network Evaluation Kit Gateway.

Objectives

- Select RN Module, Confirm RN2903 module type (Figure 6-1)

FIGURE 6-1: RN MODULE MAC CHANNELS

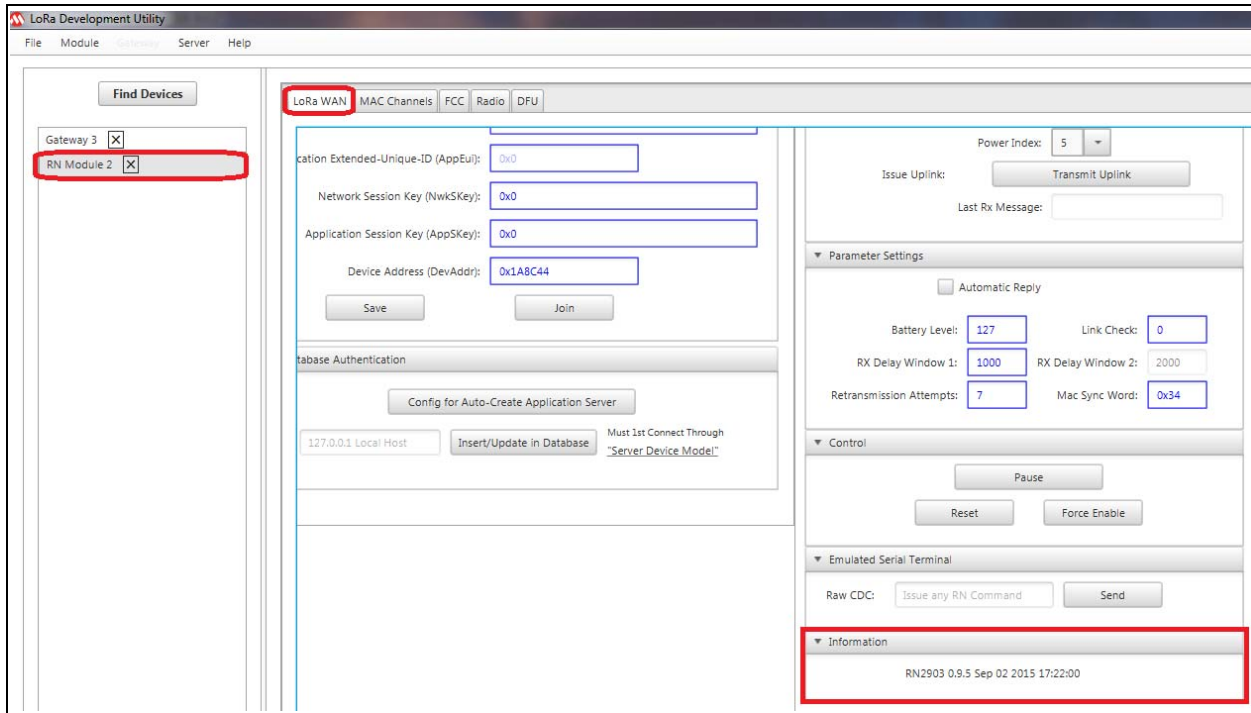

LoRa[®] Technology Evaluation Suite User's Guide

- Select **MAC Channels** Tab (Figure 6-2)

FIGURE 6-2: MAC CHANNELS TAB

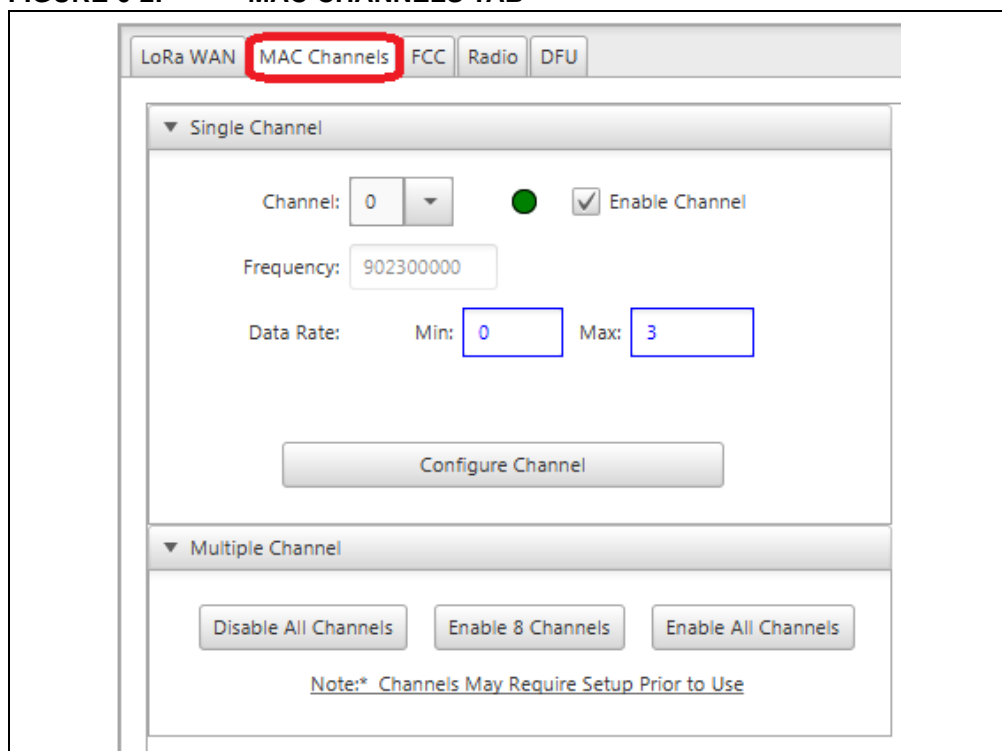

- Press **Disable All Channels** button (Figure 6-3)

FIGURE 6-3: DISABLE CHANNELS

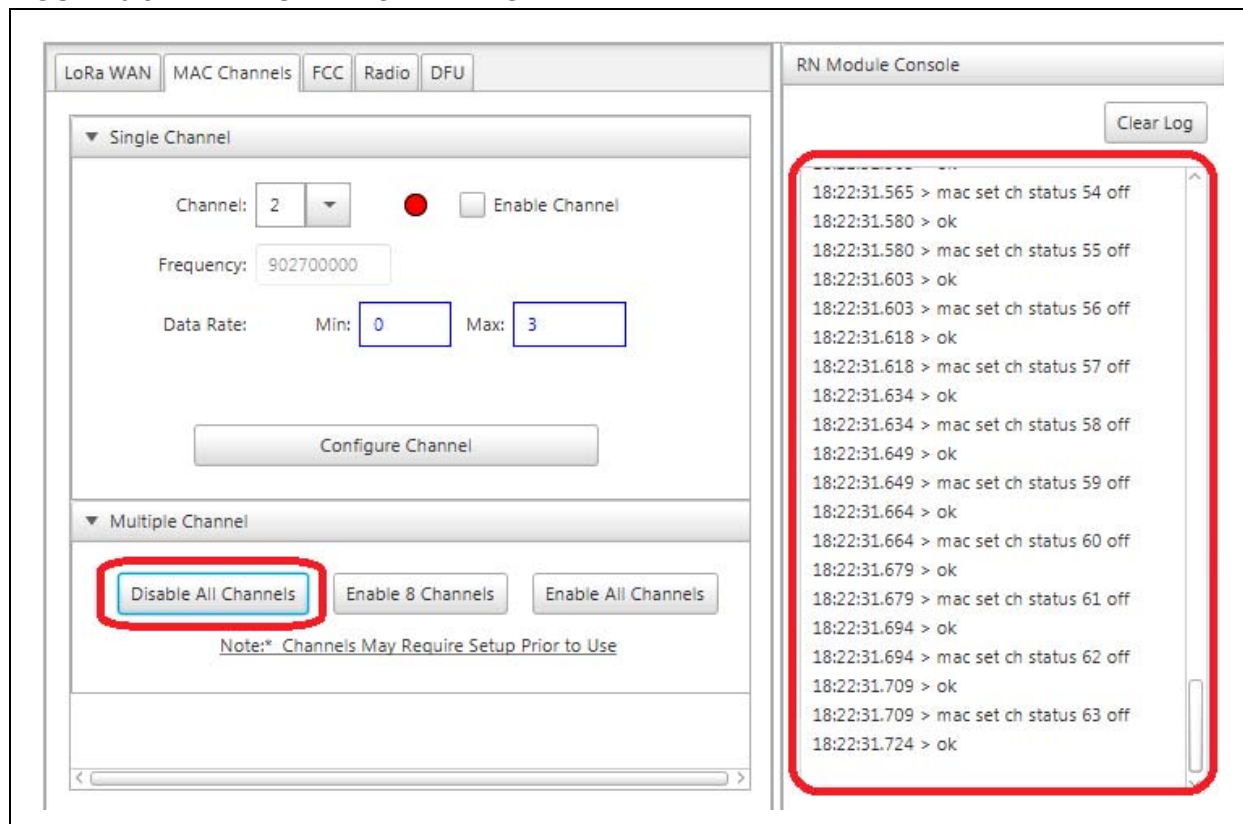

Additional Setup for Operation at 915 MHz

- Press **Enable 8 Channels** button (Figure 6-4)

FIGURE 6-4: ENABLE CHANNELS

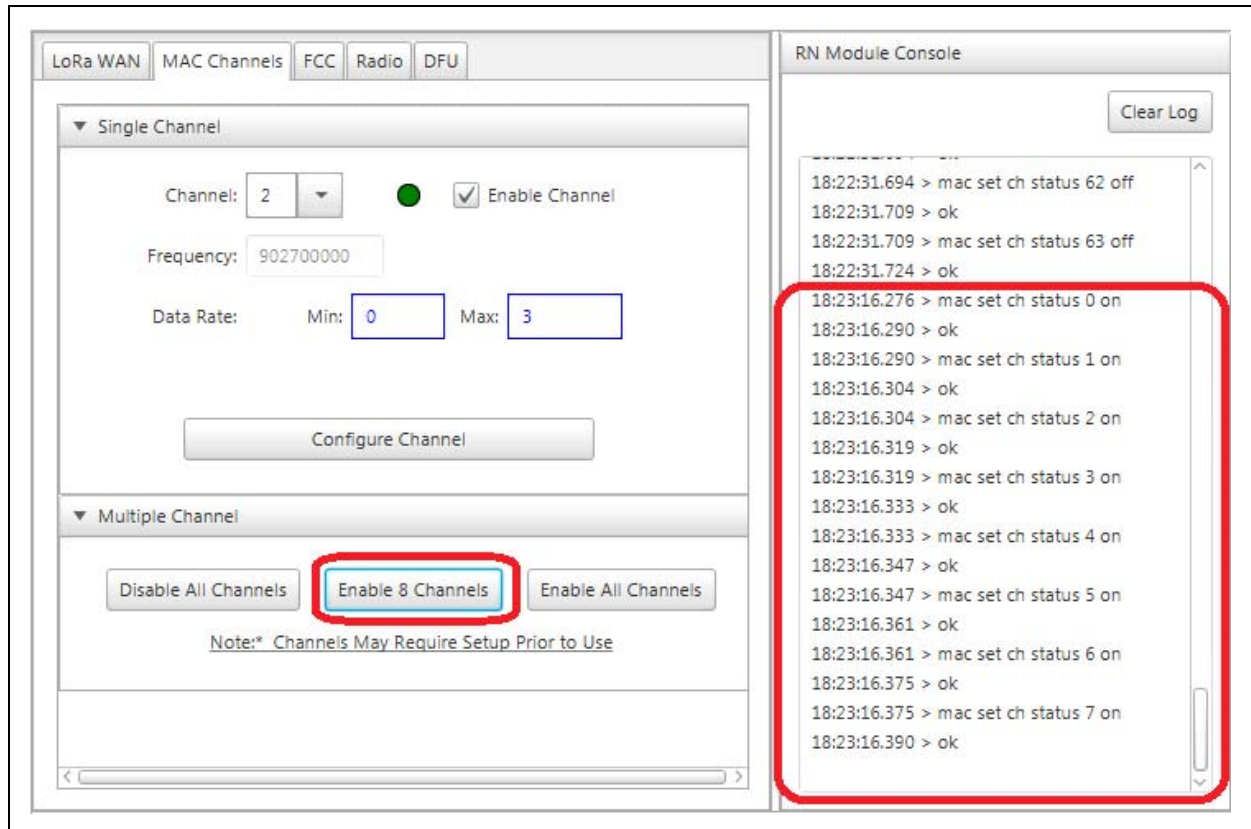

Description

Prior to using the RN Module populated end devices with the Microchip Gateway, it is necessary to configure the LoRaWAN Channels for use. By default the RN2483 868 MHz module has channels (0-2) enabled, leaving channels (3-15) disabled. For the purpose of this Chapter's exercise no changes are required. If using the RN2483, skip to the next section.

The RN2903 915 MHz module has its full range of channels (0-63) enabled by default. The Microchip Gateway Radio board is only capable of eight channels of operation. By default it will use the lower eight channels; as a result, the RN2903 end-device channels must be configured for use (Figure 6-1). This can quickly and easily be done through the Utility by selecting the **Module** from the Device List, then selecting the **MAC Channels** tab; seen in Figure 6-2.

When a LoRaWAN Uplink is issued from the End Device, it will do so only on the enabled channels. So to ensure that only the desired channels will be used, first disable all channels by pressing the **Disable All Channels** button, as seen in Figure 6-4. The RN Module Console to the right will show the commands sent to the RN Module to disable the channels.

By then using the **Enable 8 Channels** (Figure 6-4), only the lower eight channels will be enabled. Again in the RN Module Console, the user can observe the RN Module commands being sent. With this completed, the user can return to the **LoRaWAN** tab.

6.2 ISSUE UNCONFIRMED DUMMY UPLINK

Purpose

This allows the RN Module to send a LoRaWAN Uplink Message which the Gateway will report. This allows the Gateway ID to be populated in the database inside the Gateway Units table view.

Objectives

- Issue an Uplink from the RN Module (Figure 6-5)
- Select **LoRaWAN** Tab (Figure 6-5)

FIGURE 6-5: RN MODULE SELECT

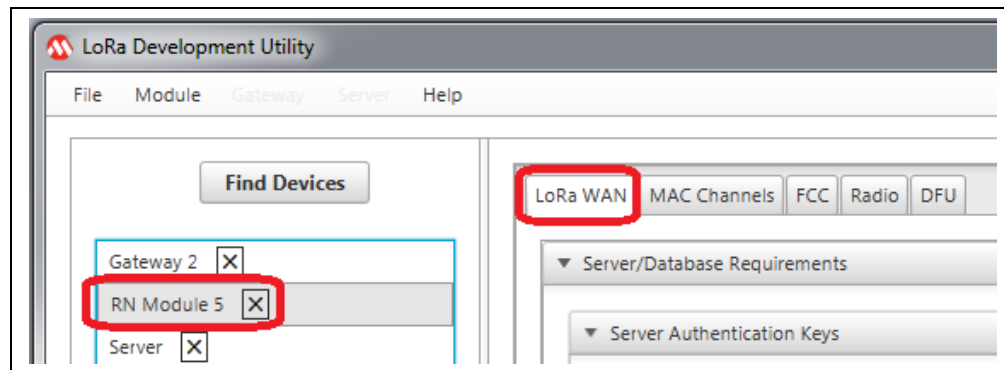

- Configure Uplink Packet Parameters (Figure 6-6)
 - Port: 15
 - Confirmed: Unchecked (False)
 - ANCI: Unchecked (False)
 - Payload: 0x01
- Press **Transmit Uplink** push button (Figure 6-6)

FIGURE 6-6: DUMMY UNCONFIRMED HEX DATA UPLINK

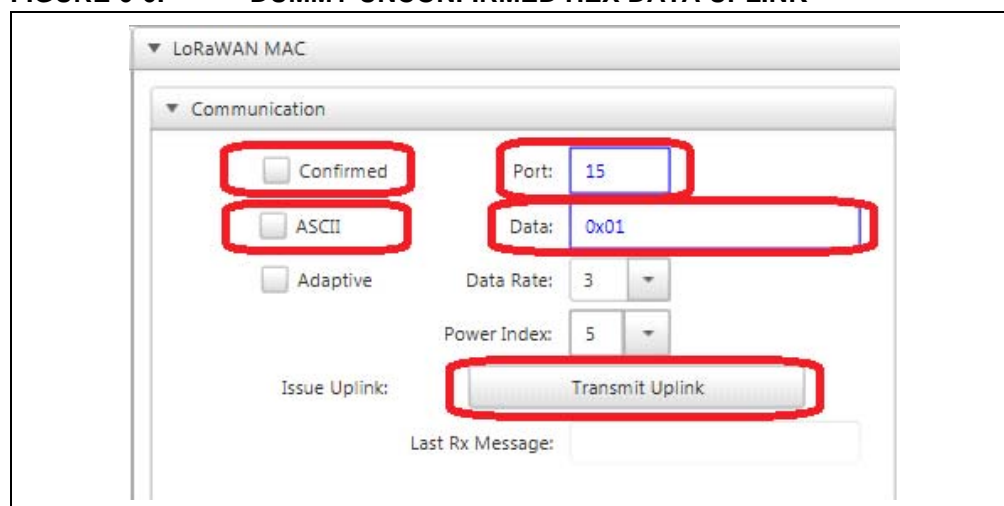

Additional Setup for Operation at 915 MHz

Description

After the device has joined the LoRaWAN network using the ABP Auto-Create form of personalization, a first transmission can be issued. Under the Communication titled pane in the LoRa MAC Control box, the Uplink settings and payload can be specified. An Uplink Message can be issued on Port Numbers: 1-223; Data payloads must be in Hex (0x).

String form is allowed when the ANCI checkbox is enabled. Once the Port number and Payload have been provided, the user can issue the Uplink by pressing the **Transmit Uplink** button. Figure 6-5 shows the key elements described in this section.

6.3 CHANGE GATEWAY REGION

Purpose

The server assumes all Gateway Units connecting are initially part of the 868 MHz region (Region 4). This will change the Gateway from 868 MHz (Region 4) to 915 MHz (Region 0). Proper Region settings are required by the Server.

Objectives

- Select **Server** from Device List (Figure 6-7)
- Select **Database** Tab (Figure 6-7)
- Select **Gateway Units** in combo box (Figure 6-7)

FIGURE 6-7: GATEWAY UNITS DATABASE TABLE VIEW

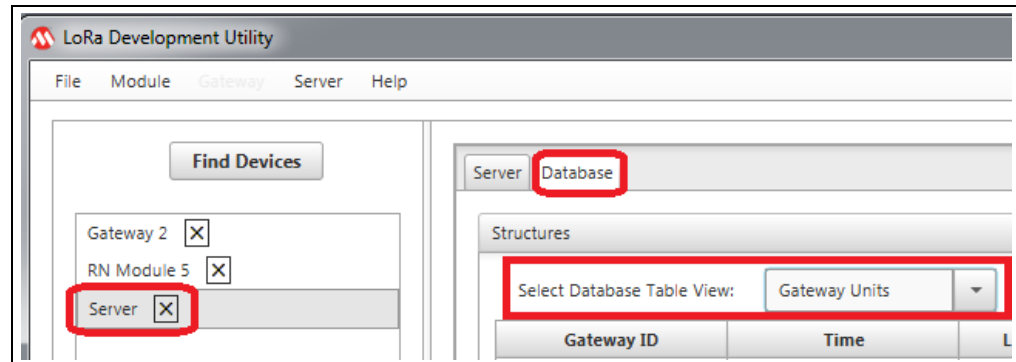

- Select row containing Gateway ID: 0x123456788764321 (Figure 6-8)
- Click **Region** push button (Figure 6-8)

FIGURE 6-8: CHANGE REGION

The screenshot shows a web interface for 'Structures' with a table of Gateway Units. The 'Change Region' button is highlighted with a red box. The table has columns: Gateway ID, Time, Latitude, Longitude, Altitude, Up Pkts Rx, Good Up Pkts Rx, Up Pkts Fwr, Up Pkts Ack Ratio, Down Pkts Rx, Pkts Tx, Last Up Pkts ID, and Region. The second row is highlighted in blue, and its 'Region' value is 4, also highlighted with a red box.

Gateway ID	Time	Latitude	Longitude	Altitude	Up Pkts Rx	Good Up Pkts Rx	Up Pkts Fwr	Up Pkts Ack Ratio	Down Pkts Rx	Pkts Tx	Last Up Pkts ID	Region
0xABCDEF0123456789	2011-01-01 07:44:35.0				70	24	24	1	0	0		0
0x1234567887654321	2011-01-01 06:18:05.0				68	0	0	0.720588	0	0		4

- Observe Region value change (Figure 6-9)

FIGURE 6-9: REGION NUMERICAL REPRESENTATION

The screenshot shows a dropdown menu titled 'Region'. The menu is open, showing two options: '4' and '0'.

Region
4
0

Description

If using the 868 MHz Gateway bandwidth, skip past this section to the next. By default Gateway Units are assumed to be 868 MHz by the server. Changing Region of operation for a Gateway Unit in the database is only required for 915 MHz bandwidth.

When the Gateway received its first valid Uplink packet, it should have populated itself in the database. Return to the Server Device Model, select the **Database** Tab. Use the combo box to select Database Table View, and choose Gateway Units (Figure 6-7).

Select the Gateway Unit which is operating within the 915 MHz bandwidth, once selected the row will become highlighted in blue. With the proper Gateway Row selected, press the **Change Region** push button; this button is only visible under Gateway Unit table view. This will change the value stored in the Region column (Figure 6-8, Figure 6-9).

Gateway Regions:

- 0 – 915 MHz
- 4 – 868 MHz

Previously, when the Gateway received the Uplink issued in [Section 6.2 “Issue Unconfirmed Dummy Uplink”](#), it was still considered to be a 868 MHz Gateway, and so the Server did not accept its packet from the 915 MHz bandwidth. With the Region properly set for (0) 915 MHz bandwidth, return to the RN Module and again press **Transmit Uplink** to repeat the previous Uplink Message. Now with the Gateway properly configured in the database, the packet will be processed.

Chapter 7. Auto-Create Example Implementation

7.1 ISSUE UNCONFIRMED UPLINK USING AUTO-CREATE PERSONALIZATION

Purpose

This will issue a LoRaWAN unconfirmed Uplink Message from an End Device using **Auto-Create** personalization keys.

Objectives

- Select RN Module configured in [Section 5.4 “Configure RN Module for Auto-Create Personalization”](#), from the Device List ([Figure 7-1](#))

FIGURE 7-1: AUTO-CREATE RN MODULE SELECTION

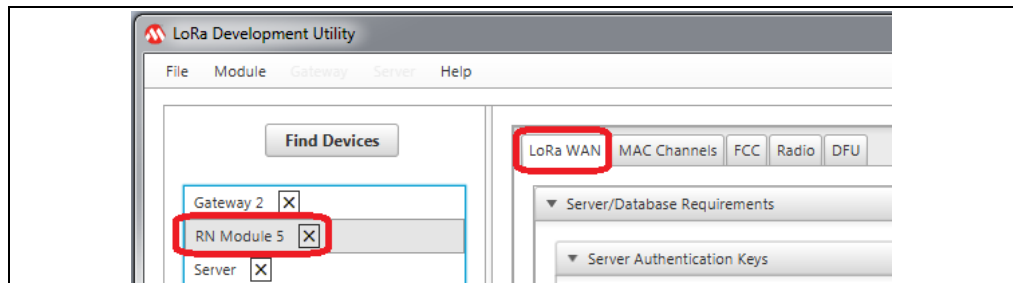

- Configure Uplink Packet Parameters ([Figure 7-2](#))
 - Port: 125
 - Confirmed: Unchecked (False)
 - ANCI: Checked (True)
 - Payload: Auto-Create Uplink
- Press **Transmit Uplink** push button ([Figure 7-2](#))

FIGURE 7-2: ISSUE UNCONFIRMED AUTO-CREATE ASCII UPLINK

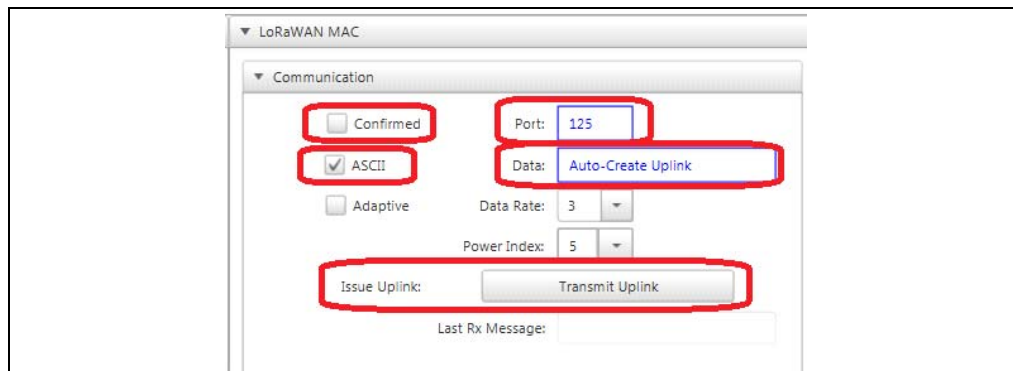

Description

After the device has joined the LoRaWAN network using the ABP Auto-Create form of personalization, a first transmission can be issued. Under the Communication titled pane in the LoRa MAC Control box the Uplink settings and payload can be specified. An Uplink Message can be issued on Port Numbers: 1-223; Data payloads must be in Hex (0x).

LoRa[®] Technology Evaluation Suite User's Guide

String form is allowed when the ANCI checkbox is enabled. Once the Port number and Payload have been provided, the user can issue the Uplink by pressing the **Transmit Uplink** button. [Figure 7-2](#) shows the key elements described in this section.

7.2 CONFIRM GATEWAY CAPTURE

Purpose

This gives simple visual confirmation that the Gateway detected the Uplink.

Objectives

- Select **Gateway** from Device List ([Figure 7-3](#))

FIGURE 7-3: GATEWAY SELECTION

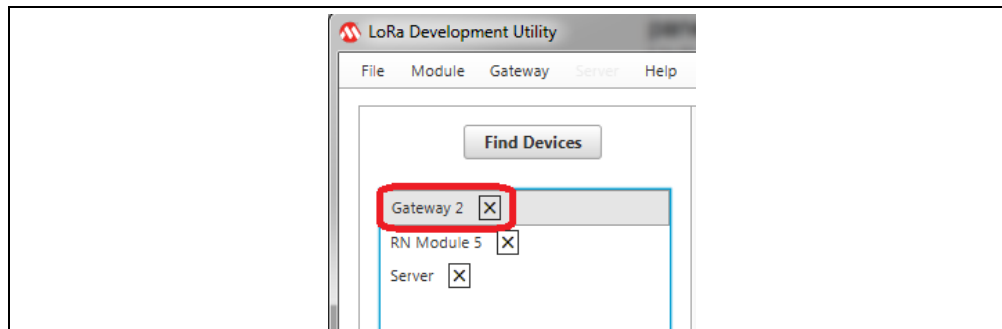

- Confirm **Packets Received** values has increased ([Figure 7-4](#))

FIGURE 7-4: PACKETS RECEIVED DISPLAY

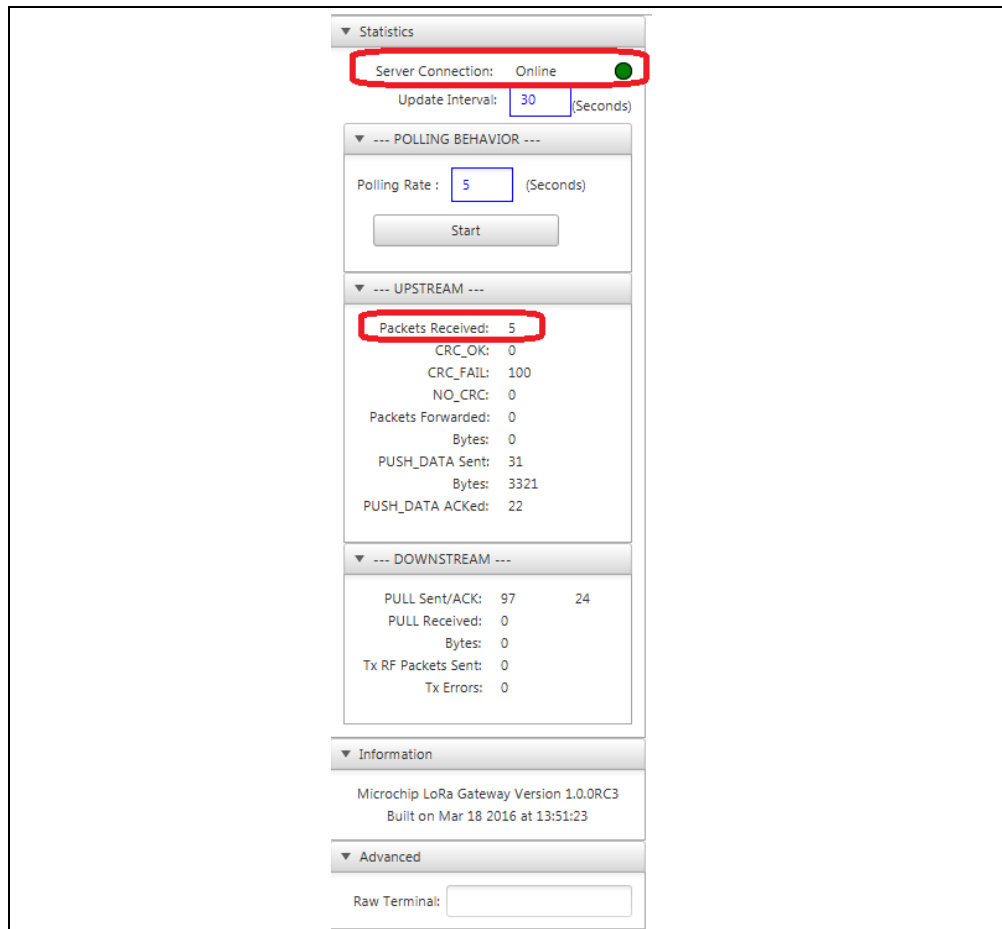

Auto-Create Example Implementation

Description

With the Gateway Polling Request running, a `sys get report` command is issued from the Utility to the Gateway at the rate (in Seconds) specified through the text field. Because the Utility is threaded, the Utility will request report information even if the Gateway is not currently selected in the Device List.

7.3 VIEW UPLINK MESSAGE IN DATABASE

Purpose

This confirms that the Uplink Message was received by the Server, and was considered valid.

Objectives

- Select **Server** from Device List (Figure 7-5)
- Select **Database** Tab (Figure 7-5)
- Select **Application Data** from combo box (Figure 7-5)

FIGURE 7-5: DATA TRAFFIC

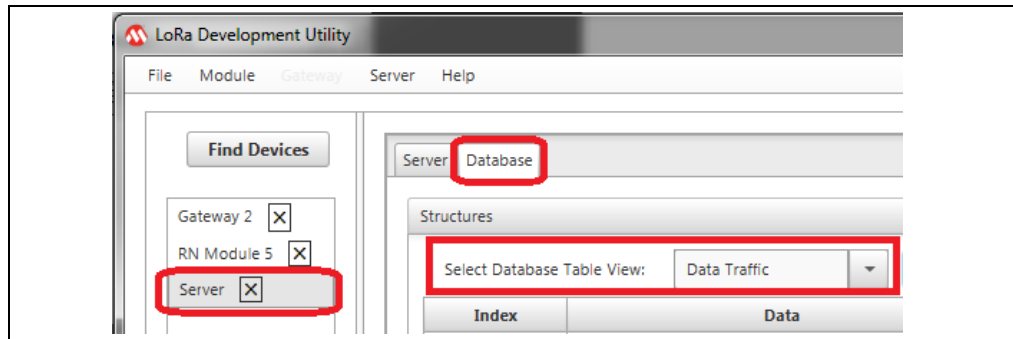

- Confirm Uplink information has been added to the database (Figure 7-6)

FIGURE 7-6: DATA IN DATABASE

Structures

Select Database Table View:

Index	Data	Ascii Data	DevAddr	Sequence Number	Accurate Time	Rx Port	Time	time uSec
#328	0x4175746f2d4372656174652055706c696e6b	Auto-Create Uplink	0x1a3fca	7	0	125	2016-03-20 22:1...	0
#327	0x02		0x1a3fca	6	0	123	2016-03-20 22:0...	0

Description

With the MySQL IP Address configured, the LoRa Development Utility should now be able to gain access to the database. In the Server Device Model, select the **Database** tab to view different table view displays. The table information is refreshed upon use of the Database View combo box, tab selection, or automatically at the rate specified when Polling is enabled. [Figure 7-6](#) shows an example of the Application Data table which is populated with valid captured Uplink Messages, such as the one sent in the previous section. All Uplink Messages transmitted by connected end devices, are displayed inside the Application Data table, regardless of the method of personalization.

Chapter 8. Activation-By-Personalization (ABP) Example Implementation

8.1 CREATE PROVISIONED (ABP) CREDENTIALS FOR SERVER**Purpose**

Create unique ABP Personalization credentials to the database.

Objectives

- Select **Server** from Device List (Figure 8-1)

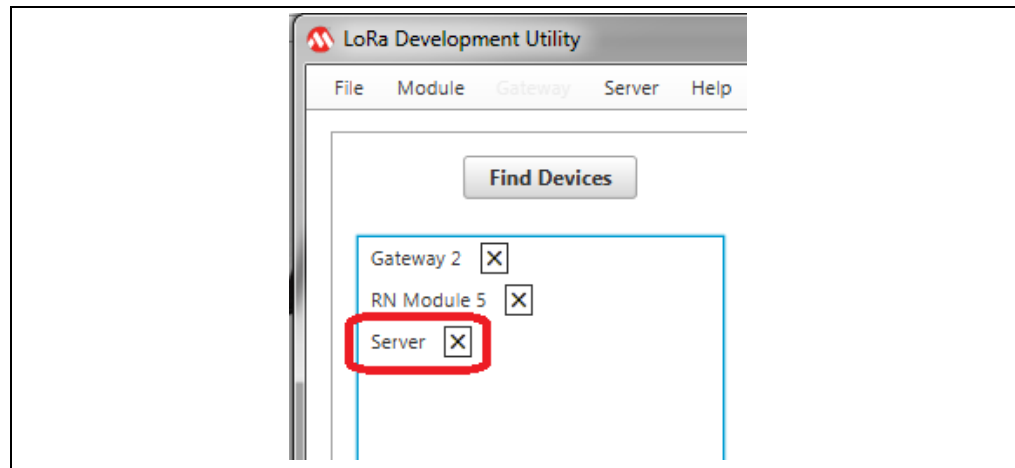
FIGURE 8-1: SERVER SELECTION

- Select **Server** Tab (Figure 8-2)
- Configure ABP Credentials Fields (Figure 8-2)
 - Network Session Key (NwkSKey): 0x99
 - Application Session Key (AppSKey): 0x87
 - Device Address (DevAddr): 0x42
- Press **Insert/Update to Database** push button (Figure 8-2)

FIGURE 8-2: PROVISIONED (ABP) DEVICE ADDITION

Description

Auto-Creation is a form of Activation-By-Personalization (ABP) network joining, used for a very specific purpose. As previously discussed, for that method of Personalization, Network Session Key (NwkSKey) and Application Session Key (AppSKey) are shared across devices, with only the Device Address (DevAddr) required to be unique. This allows for the ability to quickly and easily get a network running, but is not the typical implementation of a Personalization Authentication process.

Normally, when attempting to join a network through the ABP method, the Network Session Key (NwkSKey) and Application Session Key (AppSKey) assigned to an End Device are specific to the Device Address (DevAddr). This means that no two end devices in the network should contain shared Network Session Key (NwkSKey) or Application Session Key (AppSKey) values. Typically, the owner of a LoRa Server will create and maintain a list of valid end devices allowed onto the network. This list contains all unique Device Address, with unique Network Session Key, and Application Session Key values predetermined and managed by the LoRa Server.

With the server running, the LoRa Development Utility makes it very simple to grant network access to end devices. Addition of ABP devices can be completed through the utility in two ways. The first method of adding a device can be done from the Server Device Model, under the **Server** tab. For this process, the End Device is not required to be connected to the utility. Under the End-Device Actions titled pane is the Provisioned (ABP) titled pane. Contained inside are three text fields used to enter the required Authentication keys, along with the Device Address assigned. Once the fields have valid values entered, pressing the **Insert/Update Device in Database** push button will issue the applicable MySQL commands to give the MySQL IP Address. This will result in either an Insert, if the Device Address is new; or an Update if the Device Address currently exists in the system and simply required Authentication Key changes. [Figure 8-3](#) and [Figure 8-3](#) give an example of entering the information necessary for a Provisioned device.

Activation-By-Personalization (ABP) Example Implementation

FIGURE 8-3: ZOOM ON PROVISIONED (ABP) ACCESS TITLED PANE

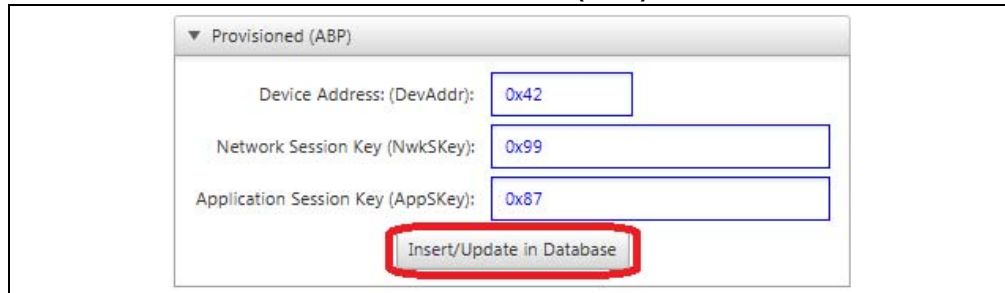

Addition of Provisioned (ABP) devices can also be done from the RN Module model view from the LoRa Development Utility. This is used to grant instant access to end devices physically connected to the same PC as the LoRa Development Utility. For MySQL commands to be issued, the specified MySQL IP Address in the Database Authentication titled pane must be valid. With all required Authentication parameter values entered into the text fields, the LoRa Development Utility will issue the required MySQL commands at the press of the **Insert/Update to Database** push button. [Figure 8-4](#) and [Figure 8.2](#) give an example of how to add a Provisioned (ABP) device from the RN Module model view.

FIGURE 8-4: GRANTING PROVISIONED (ABP) ACCESS TO AN END DEVICE FROM SERVER MODEL VIEW

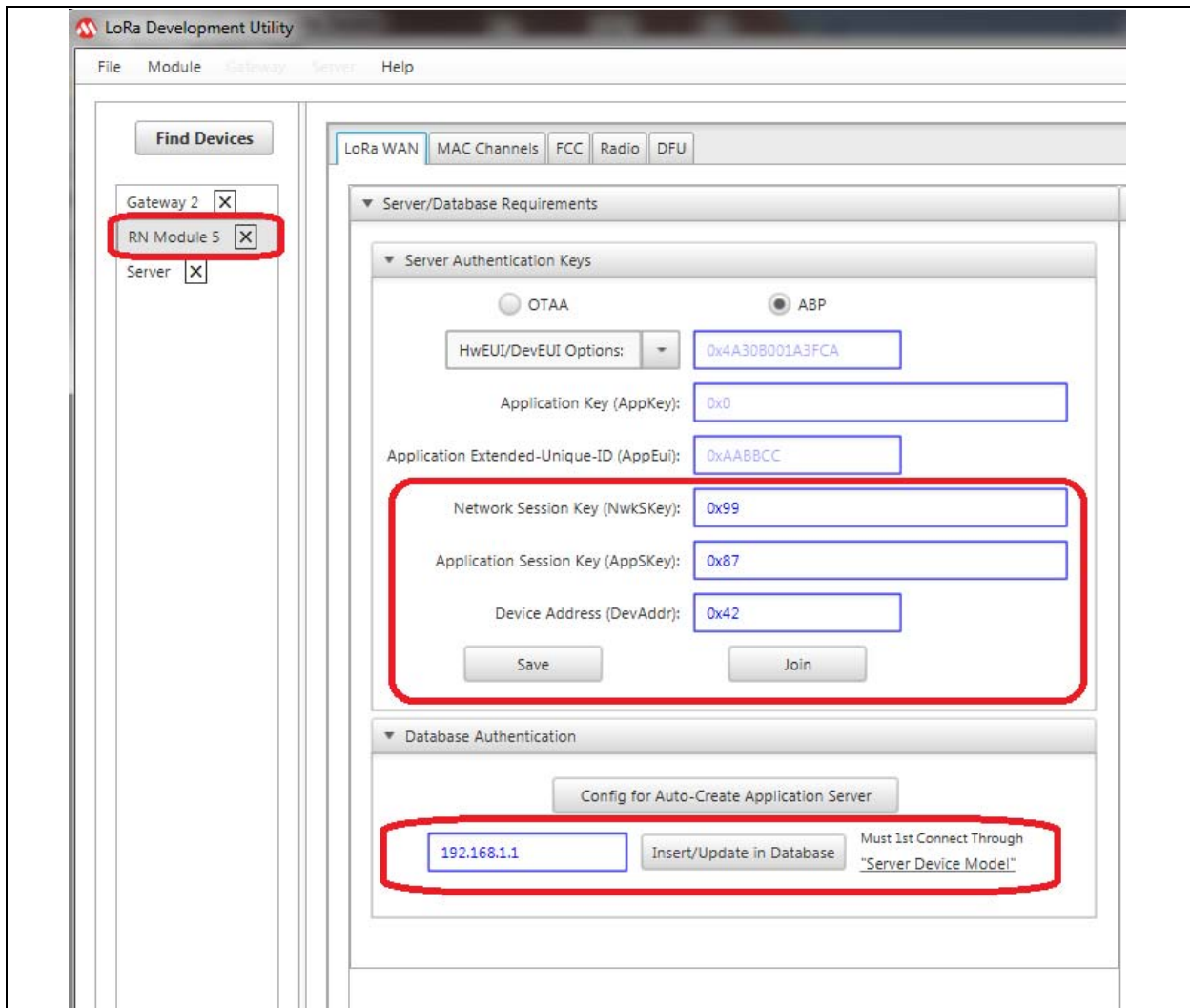

8.2 CONFIRM ABP ADDITION IN DATABASE

Purpose

Confirms requested addition of ABP device was accepted and processed by the Server.

Objectives

- Select **Server** from Device List (Figure 8-5)

FIGURE 8-5: SERVER SELECTION

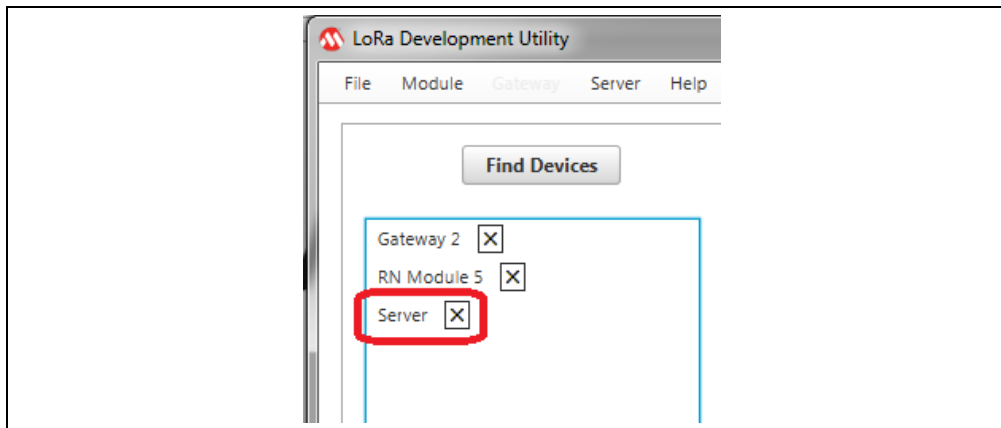

- Select **Database** Tab (Figure 8-6)
- Select **ABP Devices** from combo box (Figure 8-6)

FIGURE 8-6: ABP DEVICES TABLE VIEW

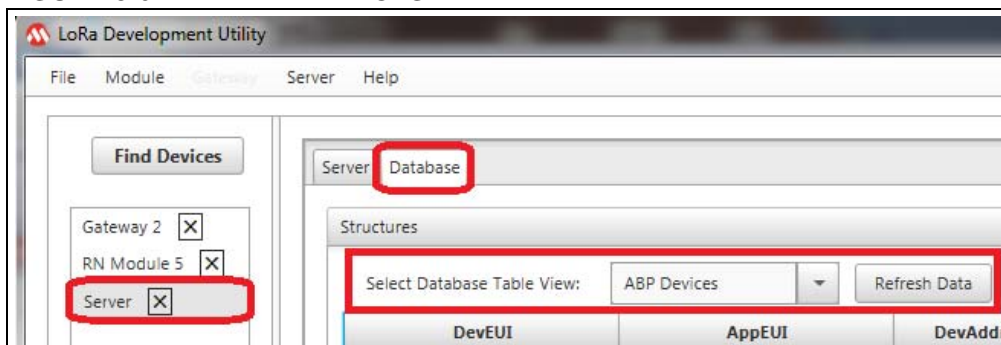

- Confirm **Added Credentials** inside Table ([Figure 8-7](#))

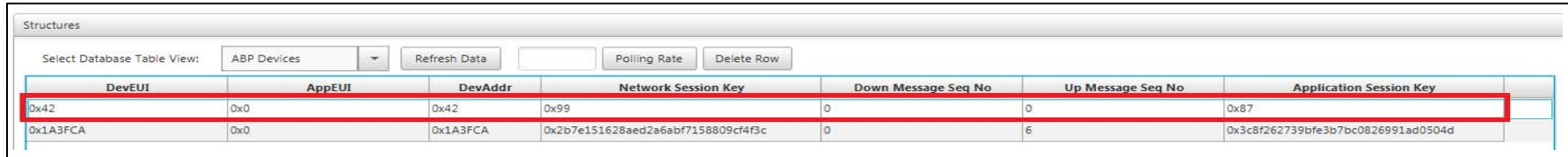
FIGURE 8-7: ABP DEVICES ADDITION

DevEUI	AppEUI	DevAddr	Network Session Key	Down Message Seq No	Up Message Seq No	Application Session Key
0x42	0x0	0x42	0x99	0	0	0x87
0x1A3FCA	0x0	0x1A3FCA	0x2b7e151628aed2a6abf7158809cf4f3c	0	6	0x3c8f262739bfe3b7bc0826991ad0504d

Description

Once the MySQL message has been issued, the Server Console should contain a sentence describing its action, or it will report MySQL connection issues. After attempting to grant access to a Provisioned (ABP) device, it can be confirmed by entering the Server model in the LoRa Development Utility. Select the ABP Devices Database view from the combo box under the **Database** tab, ([Figure 8-6](#)). This renders a table with all valid ABP Devices, including those connected using Auto-Create, or the Provisioned (ABP) methods described above, ([Figure 8-7](#)).

8.3 SAVE ABP CREDENTIALS TO RN MODULE

Purpose

Configure and Save ABP Authorization Keys to RN Module.

Objectives

- Select **RN Module** from Device List (Figure 8-8)
- Select **LoRaWAN** Tab (Figure 8-8)

FIGURE 8-8: RN MODULE SELECTION

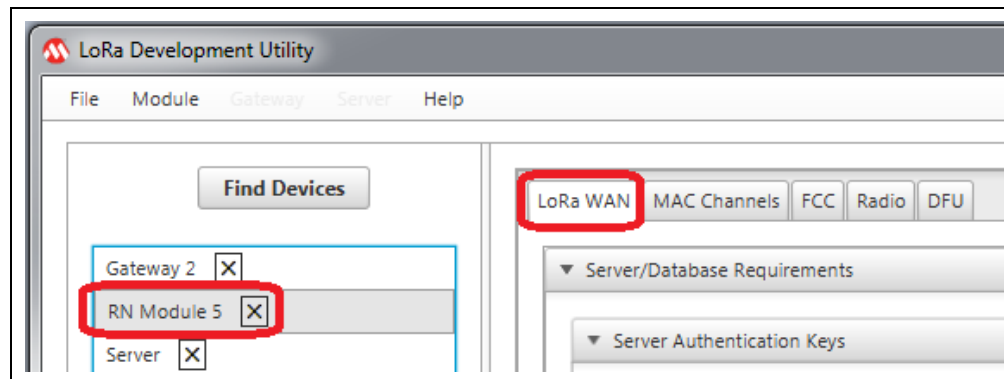

- Configure Server Authentication Keys (Figure 8-9)
 - Network Session Key (NwkSKey): 0x99
 - Application Session Key (AppSKey): 0x87
 - Device Address (DevAddr): 0x42
- Press **Save** push button (Figure 8-9)

FIGURE 8-9: ABP AUTHENTICATION KEYS

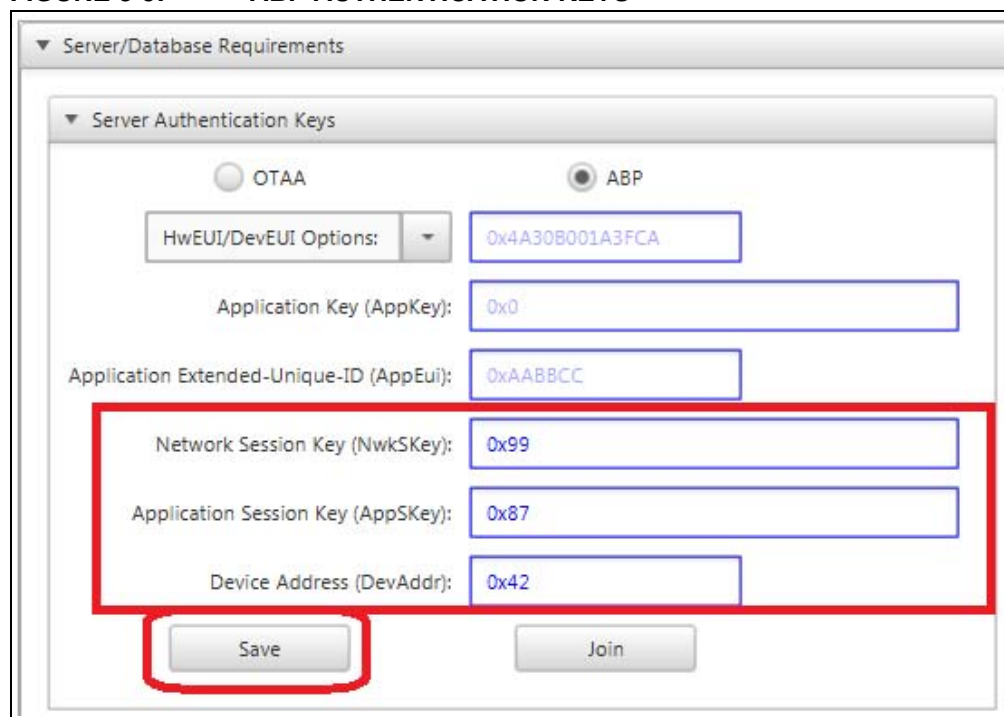

Activation-By-Personalization (ABP) Example Implementation

Description

After creating new credentials for a valid Provisioned (ABP) end devices inside the LoRa Server, it is necessary to issue a Restart, as discussed in [Section 4.4 “Create Docker Container”](#). This is a current limitation of the example server, and must be done for all new additions.

Once creation of a new end-device credentials has been completed, the server will be ready for communication. Confirmation of credentials can be done by finding device information added to the ABP Devices Table View in the LoRa Development Utility. It is now time to connect a RN Module populated End Device, and assign the newly created authentication credentials for LoRaWAN network connection. The authentication values can be assigned using the RN Module Device Model view. Under the **LoRaWAN** tab is a titled pane titled Server/Database Requirements containing the Server Authentication Keys titled pane. Here are the text fields where the user can specify the new keys to be used for Provisioned Personalization. The user can either press **Enter** in each text field to issue specific configuration commands individually. Or press the **Save** button after entering values into the three required fields. If commands are sent individually, it is still recommended to press the **Save** button to confirm RN Module retention of the parameter values.

8.4 JOIN USING ABP CREDENTIALS

Purpose

This will allow the RN Module to perform LoRaWAN actions.

Objectives

- Select same **RN Module** from [Section 8.3 “Save ABP Credentials to RN Module”](#)
- Select **LoRaWAN** Tab ([Figure 8-10](#))

FIGURE 8-10: RN MODULE SELECTION

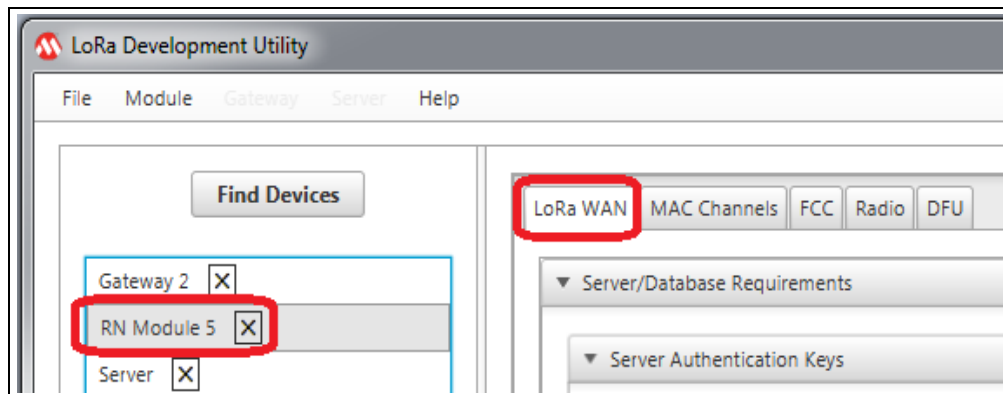

- Press **Join** push button ([Figure 8-11](#))

FIGURE 8-11: JOIN USING ABP

The screenshot shows a configuration window titled "Server Authentication Keys". At the top, there are two radio buttons: "OTAA" (unselected) and "ABP" (selected). Below this, there is a dropdown menu for "HwEUI/DevEUI Options" with the value "0x4A308001A3FCA". The following fields are: "Application Key (AppKey): 0x0", "Application Extended-Unique-ID (AppEui): 0xAABBCC", "Network Session Key (NwkSKey): 0x99", "Application Session Key (AppSKey): 0x87", and "Device Address (DevAddr): 0x42". At the bottom, there are two buttons: "Save" and "Join". The "Join" button is highlighted with a red rectangular border.

Description

Once parameter values have been saved, the user can press **Join** to allow LoRaWAN protocol. [Figure 8-12](#) shows an example configuration of a RN Module using ABP Personalization through the LoRa Development Utility.

FIGURE 8-12: JOINING A PROVISIONED (ABP) DEVICE

This screenshot is similar to Figure 8-11, but with additional annotations. The "ABP" radio button is highlighted with a red rectangular border. A larger red rectangular border encompasses the "Network Session Key (NwkSKey): 0x99", "Application Session Key (AppSKey): 0x87", and "Device Address (DevAddr): 0x42" fields. At the bottom, there are two buttons: "Save" and "Join". A red arrow points to the "Save" button, and a blue arrow points to the "Join" button.

Activation-By-Personalization (ABP) Example Implementation

8.5 ISSUE UNCONFIRMED UPLINK USING ABP PERSONALIZATION

Purpose

This will issue an unconfirmed Uplink Message through use of unique ABP credentials.

Objectives

- Select same **RN Module** from [Section 8.4 “Join Using ABP Credentials”](#)
- Select **LoRaWAN** Tab ([Figure 8-13](#))

FIGURE 8-13: RN MODULE SELECTION

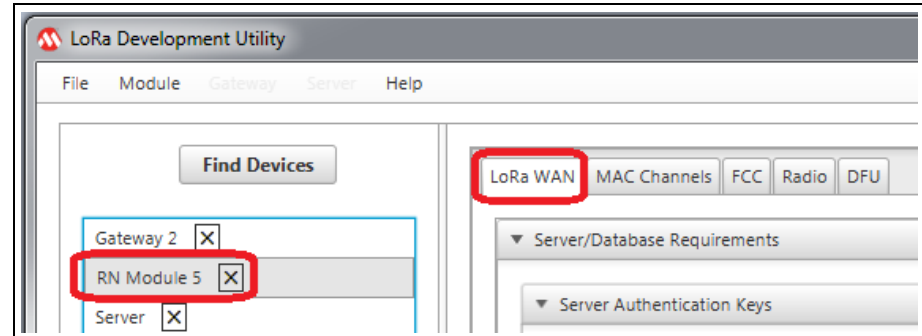

- Configure Communication Parameters ([Figure 8-14](#))
 - Port: 101
 - Confirmed: Unchecked (False)
 - ANCI: Checked (True)
 - Payload: ABP Uplink
- Press **Transmit Uplink** push button ([Figure 8-14](#))

FIGURE 8-14: ISSUE UNCONFIRMED ABP STRING UPLINK

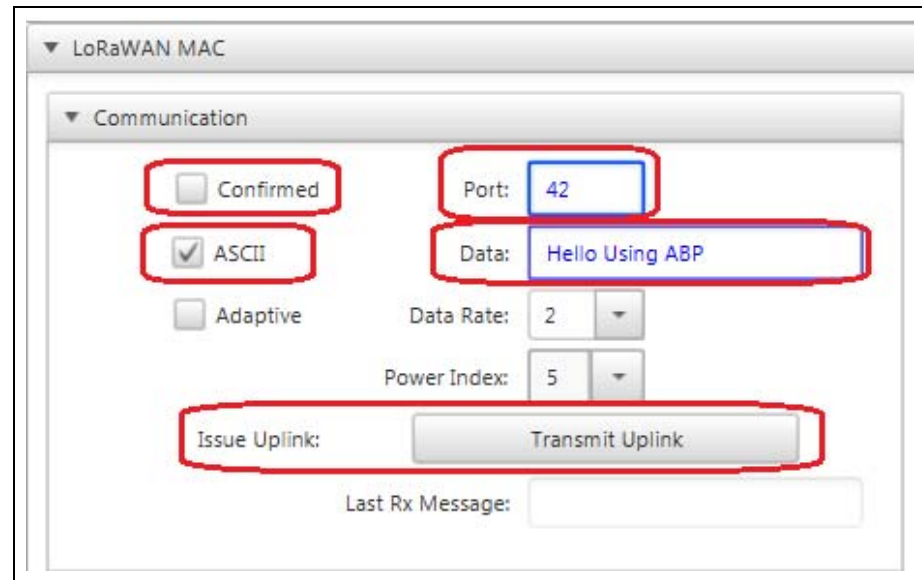

Description

After the proper authentication keys have been saved to the RN Module it is ready to issue an Uplink transmission. Under the Communication titled pane in the LoRa MAC Control box the Uplink settings and payload can be specified. This process is done the same as previously described in [Section 5.4 “Configure RN Module for Auto-Create Personalization”](#). [Figure 8-15](#) shows a possible first Uplink setup, and output message in the RN Module Console.

FIGURE 8-15: ISSUING PROVISIONED (ABP) DEVICE UPLINK MESSAGES

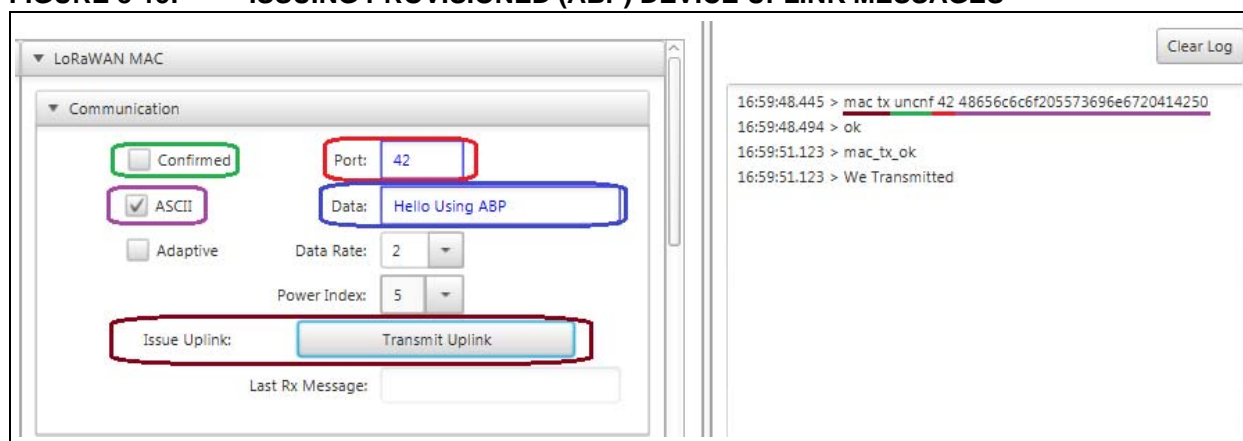

8.6 CONFIRM GATEWAY CAPTURE

Purpose

This confirms the Gateway received the Uplink.

Objectives

- Select Gateway from Device List ([Figure 8-16](#))

FIGURE 8-16: GATEWAY SELECTION

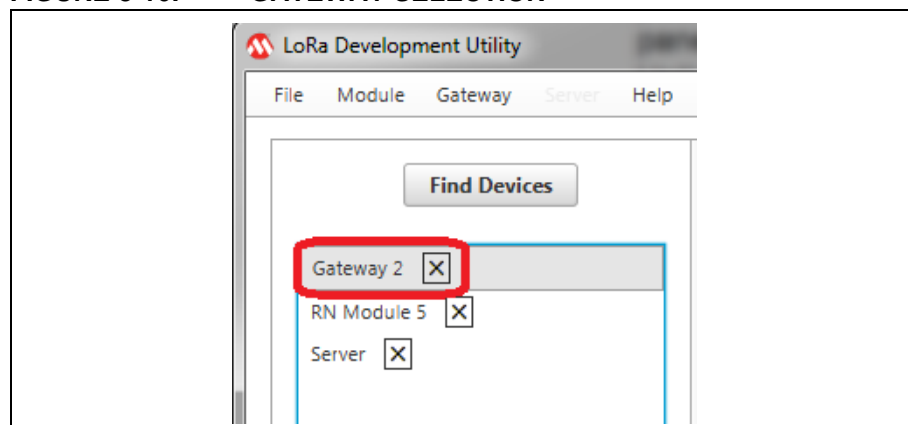

Activation-By-Personalization (ABP) Example Implementation

- Confirm Polling Request is occurring per [Section 5.3 “Configure Gateway”](#)
- Confirm **Packets Received** has increased ([Figure 8-17](#))

FIGURE 8-17: POLLING CONFIRMATION

The screenshot displays the configuration interface for a Microchip LoRa Gateway. It is divided into several sections:

- Statistics:** Shows "Server Connection: Online" with a green indicator light. Below it, "Update Interval: 30 (Seconds)" is set.
- POLLING BEHAVIOR ---:** Contains a "Polling Rate: 5 (Seconds)" input field and a "Start" button.
- UPSTREAM ---:** Displays various statistics, with "Packets Received: 5" highlighted by a red box. Other values include CRC_OK: 0, CRC_FAIL: 100, NO_CRC: 0, Packets Forwarded: 0, Bytes: 0, PUSH_DATA Sent: 31, Bytes: 3321, and PUSH_DATA ACKed: 22.
- DOWNSTREAM ---:** Shows "PULL Sent/ACK: 97 24", "PULL Received: 0", "Bytes: 0", "Tx RF Packets Sent: 0", and "Tx Errors: 0".
- Information:** Displays "Microchip LoRa Gateway Version 1.0.0RC3" and "Built on Mar 18 2016 at 13:51:23".
- Advanced:** Includes a "Raw Terminal:" input field.

Description

With the Gateway Polling Request running, a `sys get report` command is issued from the Utility to the Gateway at the rate (in seconds) is specified through the text field. Because the Utility is threaded, the Utility will request report information even if the Gateway is not currently selected in the Device List.

8.7 VIEW UPLINK IN DATABASE

Purpose

This confirms the Uplink was received and processed by the Server.

Objectives

- Select Server from Device List (Figure 8-18)

FIGURE 8-18: SERVER SELECTION

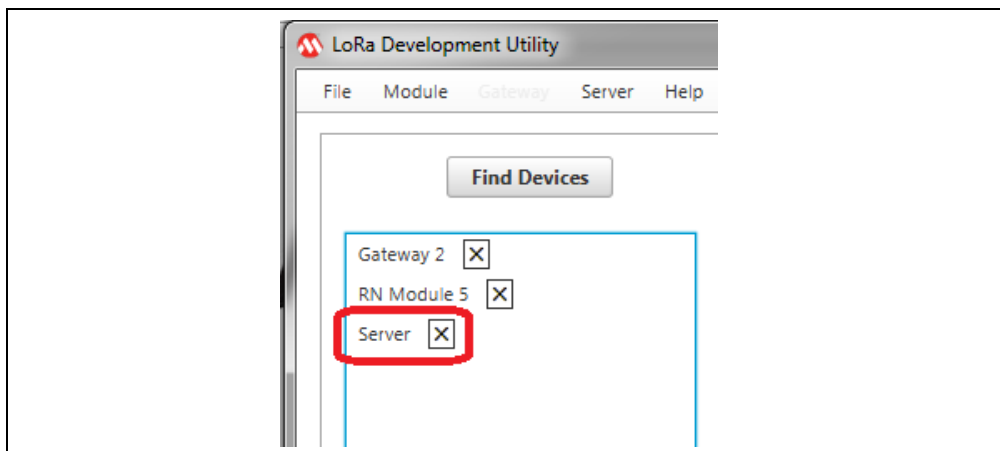

- Select **Database** Tab (Figure 8-19)
- Select Data Traffic from combo box (Figure 8-19)

FIGURE 8-19: DISPLAY APPLICATION DATA

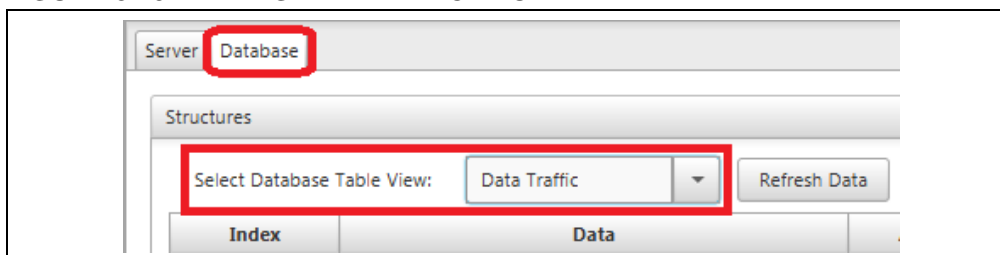

- Confirm added row from DevAddr 0x42 (Figure 8-20)

FIGURE 8-20: CAPTURE CONFIRMED

Structures

Select Database Table View: Refresh Data Polling Rate

Index	Data	Ascii Data	DevAddr	Sequence Number	Accurate Time	Rx Port	Time	time uSec
#329	0x48656c6c6f205573696e6720414250	Hello Using ABP	0x42	11	0	42	2016-03-20 22:3...	0
#328	0x4175746f2d4372656174652055706c696e6b	Auto-Create Uplink	0x1a3fca	7	0	125	2016-03-20 22:1...	0
#327	0x02		0x1a3fca	6	0	123	2016-03-20 22:0...	0

Description

With the MySQL IP Address configured, the LoRa Development Utility should now be able to gain access to the database. In the Server Device Model, select the **Database** tab to view different table view displays. The table information is refreshed upon use of the Database View combo box, tab selection, or automatically at the rate specified when Polling is enabled.

LoRa[®] Technology Evaluation Suite User's Guide

NOTES:

Chapter 9. Over-The-Air Example Implementation

9.1 CREATE A NEW APPLICATION INSIDE THE SERVER

Purpose

This will create a new application within the evaluation Server.

Objectives

- Select **Server** in the Device List (Figure 9-1)

FIGURE 9-1: SERVER SELECTION

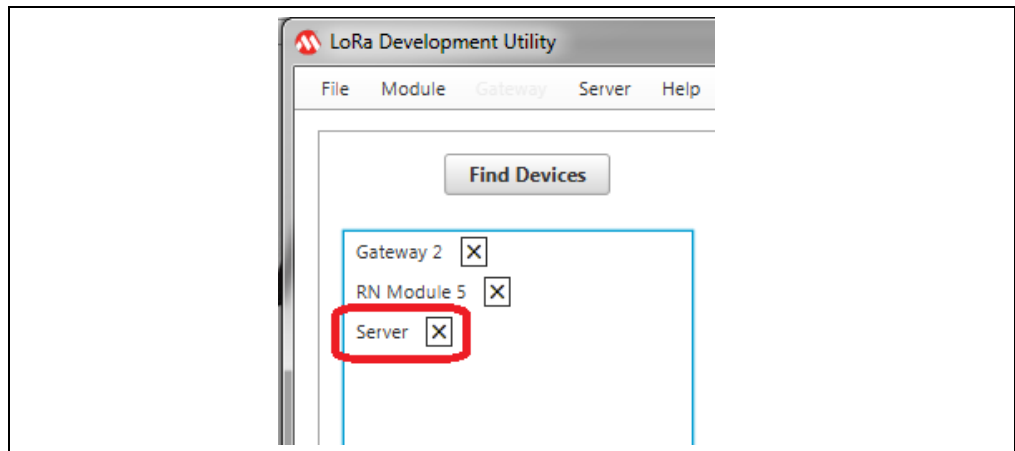

- Select **Server** Tab ()
- Configure Server Applications field parameters ()
 - Application Extended-Unique-Id (AppEUI): 0x98FE
 - Application Name: My OTAA Application
 - Application Owner: Microchip: C123
- Press **Insert/Update in Database** push button (Figure 9-2)

FIGURE 9-2: SERVER APPLICATION CREATION

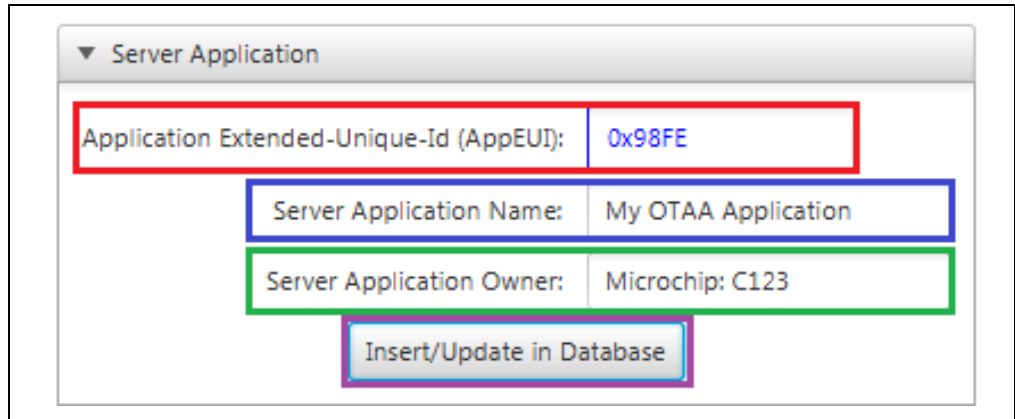

Description

After creation of a new application inside the LoRa Server, it is necessary to issue a Restart, as discussed in [Section 4.4 "Create Docker Container"](#). This is a current limitation of the example server, and must be done for all new additions.

With the creation of a new Application Server, the Over-the-Air (OTA) method of Activation may be used. Application Servers are created using a LoRa Network unique Application Extended-Unique-Identifier (AppEUI). Upon creation of the application, a Name for the server must be provided, along with reference to the Owner of the server. Name and Owner assigning of a Server is very helpful when attempting to maintain chains of responsibility, or when a single LoRa Network Server is being used for multiple LoRa application implementations.

New Application Servers may be created using the LoRa Development Utility through the Server Device Model view. Under the **Server** tab will be the titled pane Application Server contained inside the Server/Database operation pane. Three text fields are used to fill in all required parameters. If the entered Application Extended-Unique-Identifier (AppEUI) does not currently exist in the LoRaWAN network, it will be inserted into the database. If the AppEUI already exists within the network, Application Server Name and Application Server Owner information will be updated in the database. [Figure 9-3](#) provides an example of creating an Application Server through the LoRa Development Utility.

FIGURE 9-3: INSERTING/UPDATING AN APPLICATION SERVER

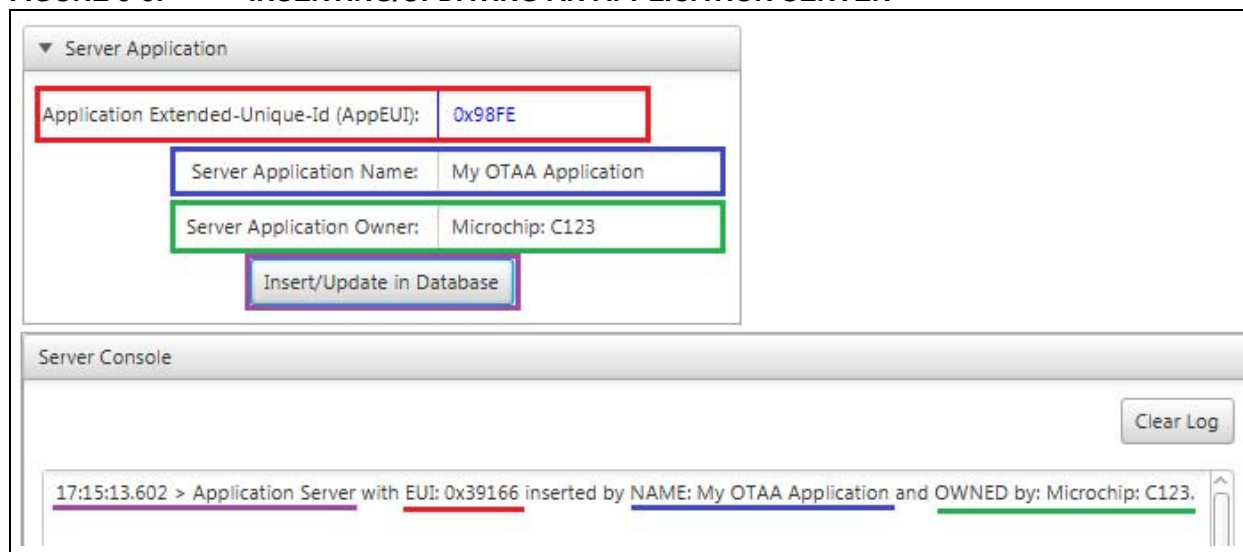

Over-The-Air Example Implementation

9.2 CREATE OTAA CREDENTIALS IN SERVER APPLICATION

Purpose

This will create end-device credentials within the Server Application.

Objectives

- Select Server in the Device List (Figure 9-4)

FIGURE 9-4: SERVER SELECTION

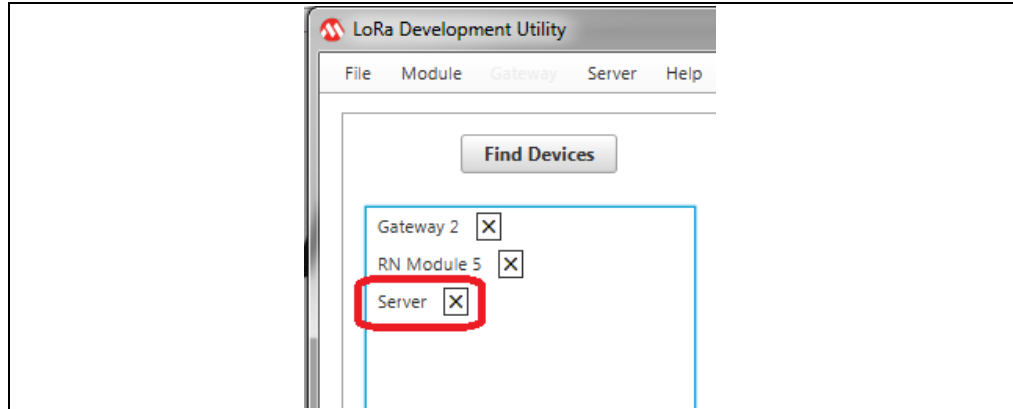

- Select **Server** Tab
- Configure Non-Provisioned (OTAA) field parameters (Figure 9-5)
 - Application Extended-Unique-Id (AppEUI): 0x98FE
 - Application Key (AppKey): 0x10F
 - Device Extended-Unique-Id: 0x809
- Press **Insert/Update in Database** push button (Figure 9-5)

FIGURE 9-5: NON-PROVISIONED (OTAA) DEVICE ADDITION

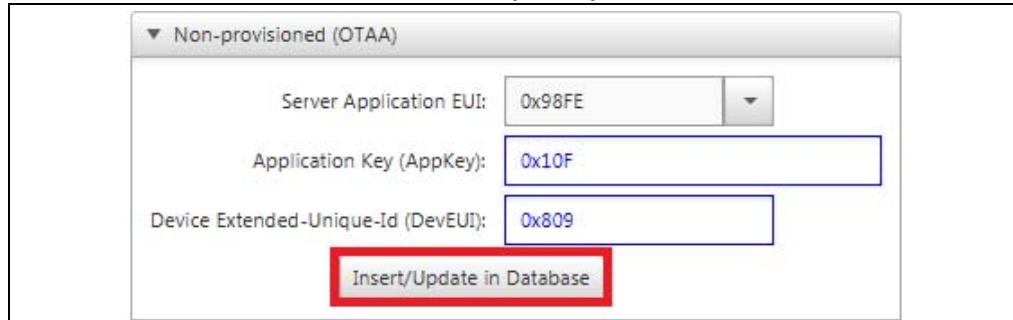

Description

After creating new Application Servers inside the LoRa Server, it is necessary to issue a Restart, as discussed in [Section 4.4 "Create Docker Container"](#). This is a current limitation of the example server, and must be done for all new additions.

Application Servers are used along with the Over-the-Air (OTA) Activation method of joining a LoRaWAN network. For this method of joining a LoRa Server, the End Device has to be given the Application Server Extended-Unique-Identifier (AppEUI) it wishes to communicate with, along with the Application Key (AppKey) which coordinates with the Device Extended-Unique-Identifier (DevEUI) of the RN Module.

For this type of networking joining, typically the end-device user/developer supplies the Application Server Owner with their Device Extended-Unique-Identifier (DevEUI), to which the Server Owner returns the Application Key (AppKey) which should be used for network authorization.

With these three key credentials stored, the End Device can now join the LoRaWAN network with access to the specific Application Server.

Once successfully “Accepted”, the server will transmit the Device Address (DevAddr) assigned to the End Device. With the server running, the LoRa Development Utility makes it very simple to grant end devices access to LoRa Network Application. Addition of OTAA devices to Application Servers can be completed through the utility in two ways. The first method of adding a device can be done from the Server Device Model, under the **Server** tab. For this process, the End Device is not required to be connected to the utility. Under the **End-Device Actions** titled pane is the Non-Provisioned (OTAA) titled pane. Contained inside is a combo box used to select from currently available Application Servers (AppEUI), along with two text fields used to enter Application Key (AppKey) and Device Extended-Unique-Identifier (DevEUI) authentication values. Once the fields have valid values entered and an Application Server is selected, pressing the **Insert/Update Device in Database** push button will issue the applicable MySQL commands to give the MySQL IP Address.

This will result in either an Insert, if the Device Extended-Unique-Identifier (DevEUI) is new to the Application Server; or an Update if the DevEUI currently exists within the AppEUI, and simply requires a new Application Key. Different Application Server's may use the same Device Extended-Unique-Identifier (DevEUI), though it is recommended to keep these LoRaWAN network unique. [Figure 9-6](#) gives an example of entering the information necessary for a Non-Provisioned device.

FIGURE 9-6: GRANTING NON-PROVISIONED (OTAA)

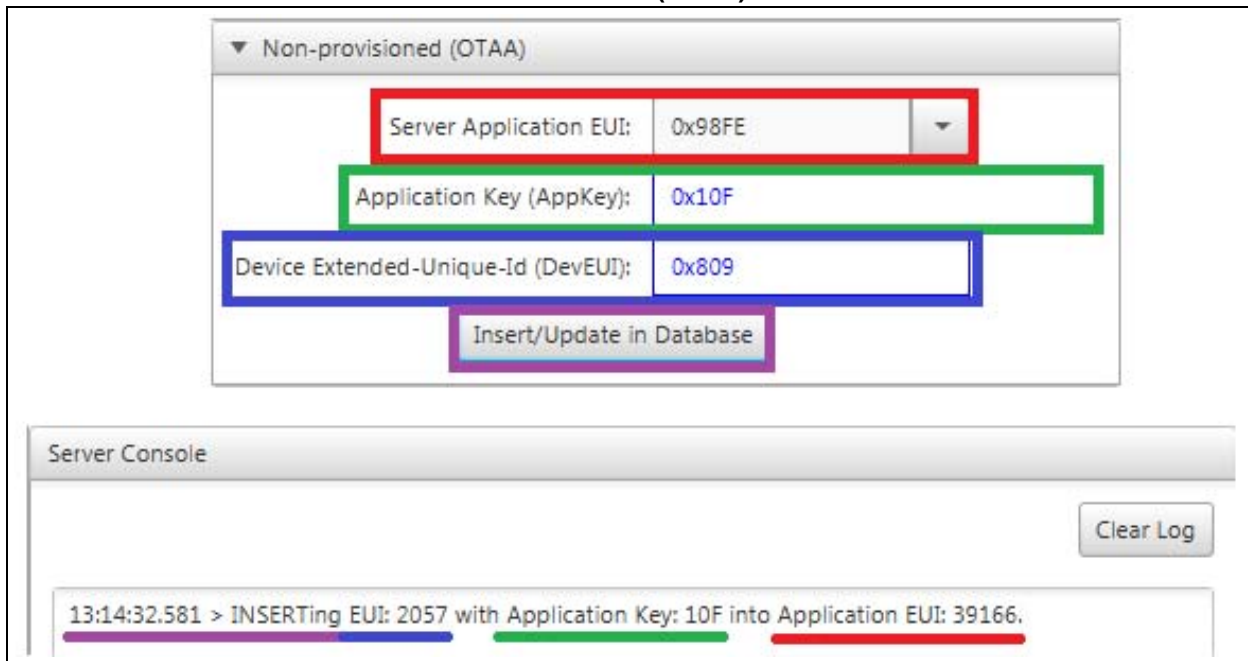

Addition of Non-Provisioned (OTAA) devices can also be done from the RN Module model view from the LoRa Development Utility. This is used to grant instant access to end devices physically connected to the same PC as the LoRa Development Utility. For MySQL commands to be issued the specified MySQL IP Address in the Database Authentication titled pane must be valid. With all required Authentication parameter values entered into the text fields, the LoRa Development Utility will issue the required MySQL commands at the press of the **Insert/Update to Database** push button.

[Figure 9-7](#) gives an example of how to add a Non-Provisioned (OTAA) device from the RN Module model view.

Over-The-Air Example Implementation

FIGURE 9-7: GRANTING NON-PROVISIONED (OTAA) ACCESS FROM RN MODULE MODEL VIEW

Server/Database Requirements

Server Authentication Keys

OTAA ABP

Use Entered (DevEui):

Application Key (AppKey):

Application Extended-Unique-ID (AppEui):

Network Session Key (NwkSKey):

Application Session Key (AppSKey):

Device Address (DevAddr):

Database Authentication

Must 1st Connect Through "Server Device Model"

9.3 CONFIRM SERVER APPLICATION ADDITION TO DATABASE

Purpose

Confirms request for Server Application creation has been received and process by the Server.

Objectives

- Select **Server** from Device List (Figure 9-8)

FIGURE 9-8: SERVER SELECTION



- Select **Database** Tab (Figure 9-9)
- Select **Server Applications** from combo box (Figure 9-9)
- Confirm addition of Application (AppEUI) row (Figure 9-9)

FIGURE 9-9: CONFIRM SERVER APPLICATION ADDITION

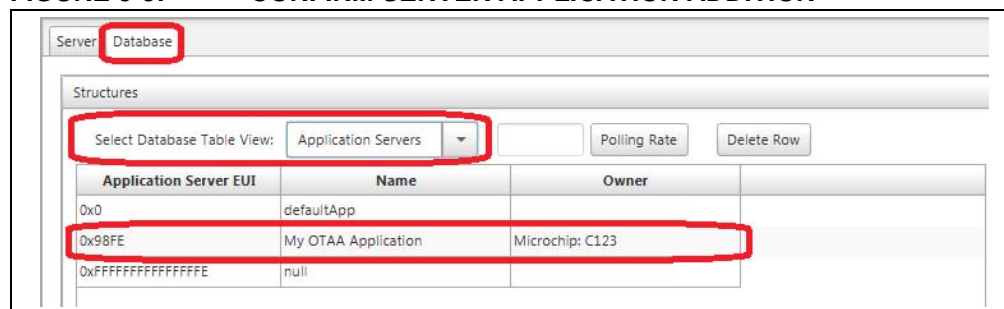

Description

Once the MySQL message has been issued, the Server Console should contain a sentence describing its action, or it will report MySQL connection issues. After attempting to create a new Server Applications within the Evaluation Server, it can be confirmed by entering the Server model in the LoRa Development Utility. Select the Server Applications Database view from the combo box under the **Database** tab. This will render a table with all valid Server Applications. Figure 9-9 shows the added Server Applications, with Application Name and Owner information displayed within the Table.

9.4 CONFIRM OTAA DEVICE ADDITION TO DATABASE

Purpose

Confirms request for OTAA device credential creation has been received and process by the Server.

Objectives

- Select **Server** from Device List (Figure 9-10)

FIGURE 9-10: SERVER SELECTION

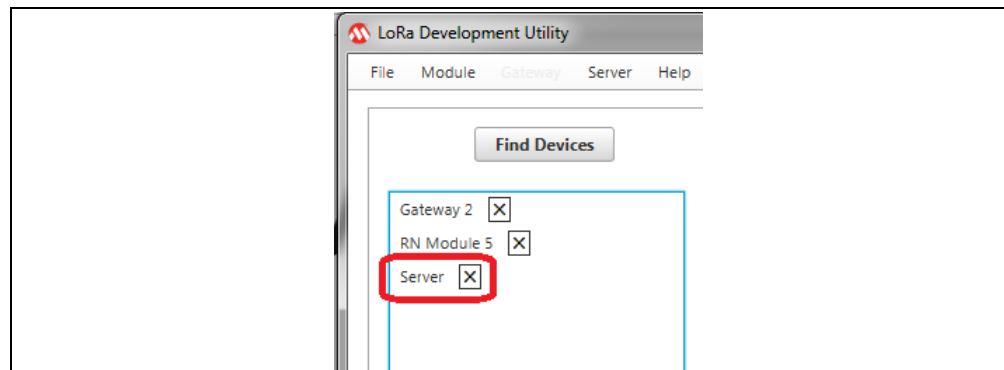

- Select **Database** Tab (Figure 9-11)
- Select **OTAA Devices** from combo box (Figure 9-11)
- Confirm addition of new OTAA Device (Figure 9-11)

FIGURE 9-11: CONFIRM OTAA DEVICE ADDITION



Description

Once the MySQL message has been issued, the Server Console should contain a sentence describing its action, or it will report MySQL connection issues. After attempting to grant access to a Non-Provisioned (OTAA) device, it can be confirmed by entering the Server model in the LoRa Development Utility. Select the OTAA Devices Database view from the combo box under the **Database** tab. This will render a table with all valid OTAA Devices. Figure 9-12 shows the added Device Extended-Unique-Id (DevEUI), with the specified Application Key (AppKey), granting access to the configured Application Server (AppEUI).

FIGURE 9-12: CONFIRMING NON-PROVISIONED (OTAA) DEVICE DATABASE ADDITION

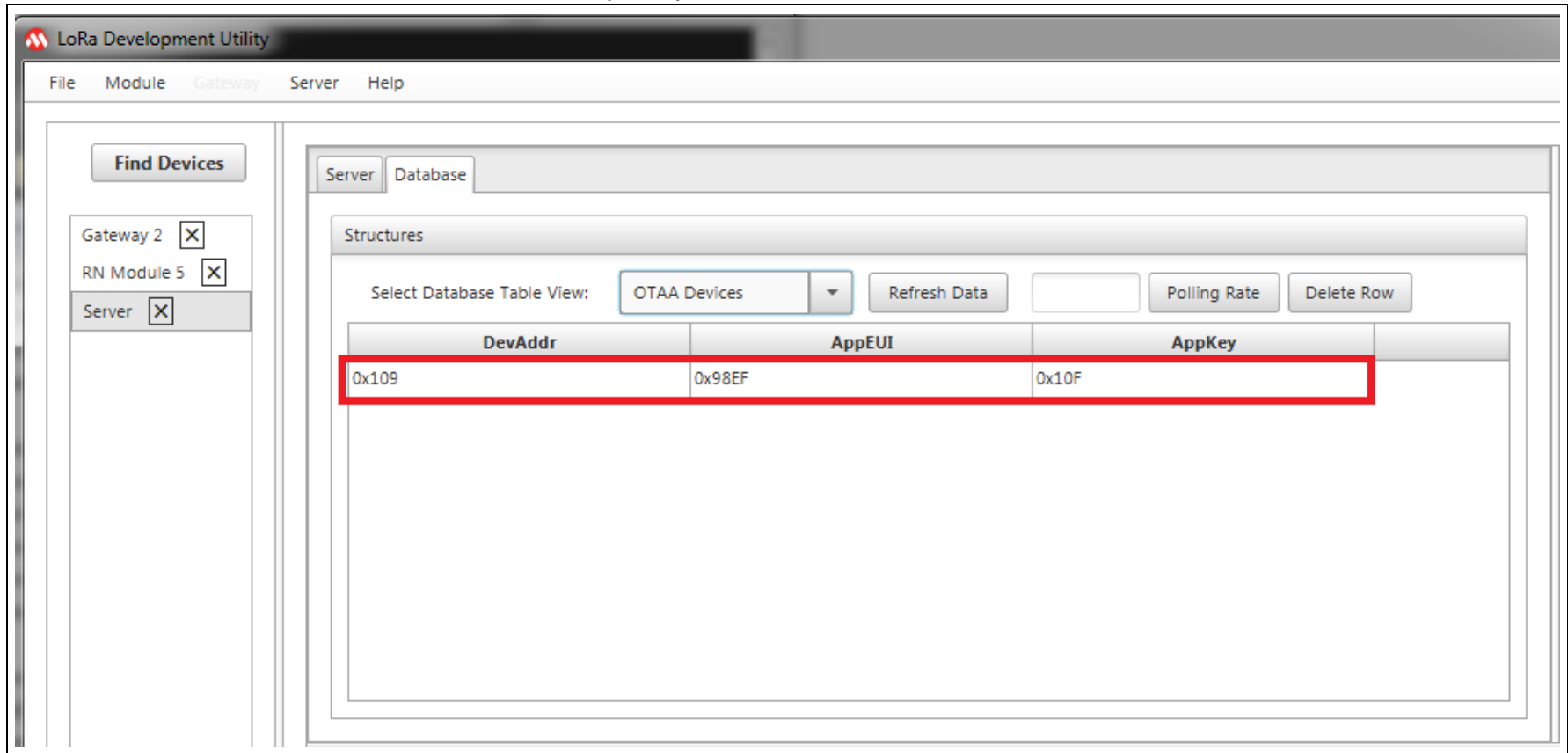

9.5 SAVE OTAA CREDENTIALS TO RN MODULE

Purpose

Configure and Save OTAA Authorization Keys to RN Module.

Objectives

- Select **RN Module** from Device List (Figure 9-13)
- Select **LoRaWAN** Tab (Figure 9-13)

FIGURE 9-13: RN MODULE SELECTION

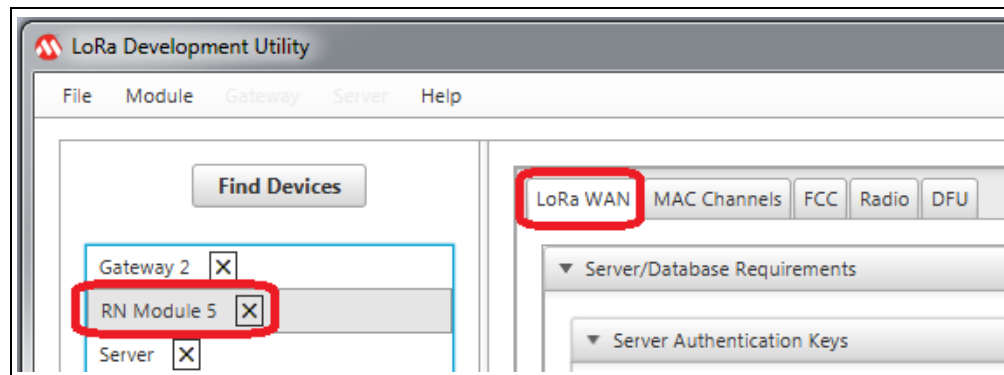

- Configure Server Authentication Keys (Figure 9-14)
 - Application Extended-Unique-Id (AppEUI): 0x98FE
 - Application Key (AppKey): 0x10F
 - Device Extended-Unique-Id: 0x809
- Press **Save** push button (Figure 9-14)

FIGURE 9-14: SAVE OTAA CREDENTIALS TO RN MODULE

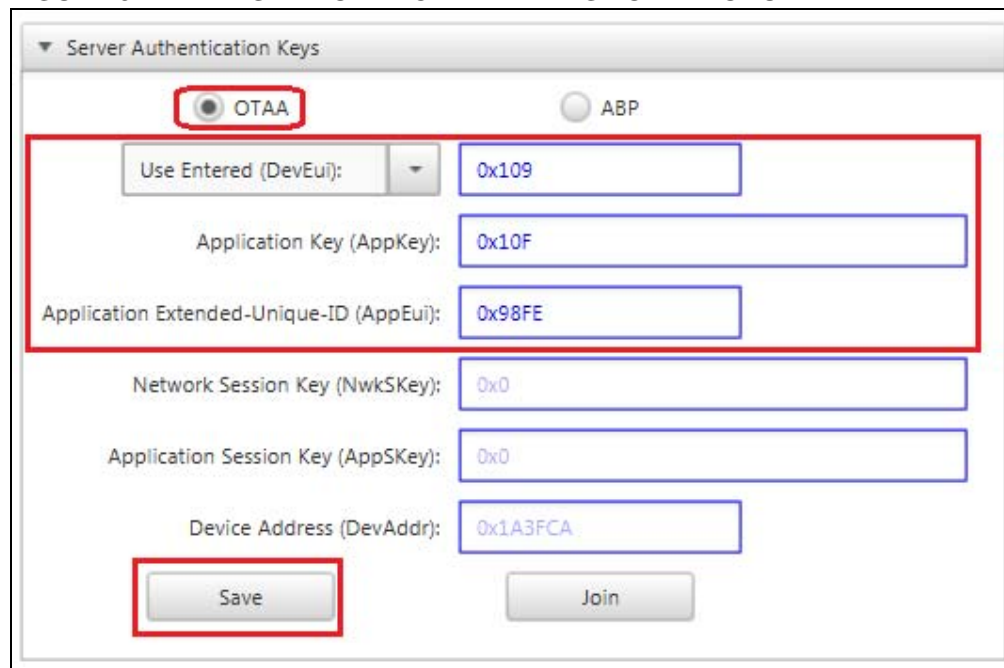

Over-The-Air Example Implementation

Description

After creating new credentials for valid Non-Provisioned (OTAA) end devices for a specific Application Server inside the LoRa Server, it is necessary to issue a Restart, as discussed in [Section 4.4 “Create Docker Container”](#). This is a current limitation of the example server, and must be done for all new additions.

Once an End Device has been “Accepted” by the LoRaWAN network, the server will be ready for communication. Confirmation of credentials is achieved when the device is successfully able to Join, invalid credentials will receive a “Denied” response. Note that it is possible to be “Denied” even with valid credentials, this may occur for a number of reasons (refer to *RN2483 LoRa® Technology Module Command Reference User’s Guide* (DS40001784) for additional details). If the credentials are known to be valid, continue to attempt joining until “Accepted”.

It is now time to connect a RN Module-populated End Device, by assigning the newly created authentication credentials required for LoRaWAN network connection. The authentication values can be assigned using the RN Module Device Model view. Under the **LoRaWAN** tab is a pane titled Server/Database Requirements containing the Server Authentication Keys titled pane. Here are the text fields where the user can specify the new keys to be used for Non-Provisioned Over-The-Air Personalization.

The user can either press **Enter** in each text field to issue individual configuration commands. Or press the **Save** button after entering values into the three required fields. If commands are sent individually, it is still recommended to press the Save button to confirm RN Module retention of the parameter values.

9.6 JOIN SERVER USING OTAA CREDENTIALS

Purpose

Join the Server Application within the evaluation Server using OTAA Personalization method.

Objectives

- Select **RN Module** from Device List ([Figure 9-15](#))
- Select **LoRaWAN** Tab ([Figure 9-15](#))

FIGURE 9-15: RN MODULE SELECTION

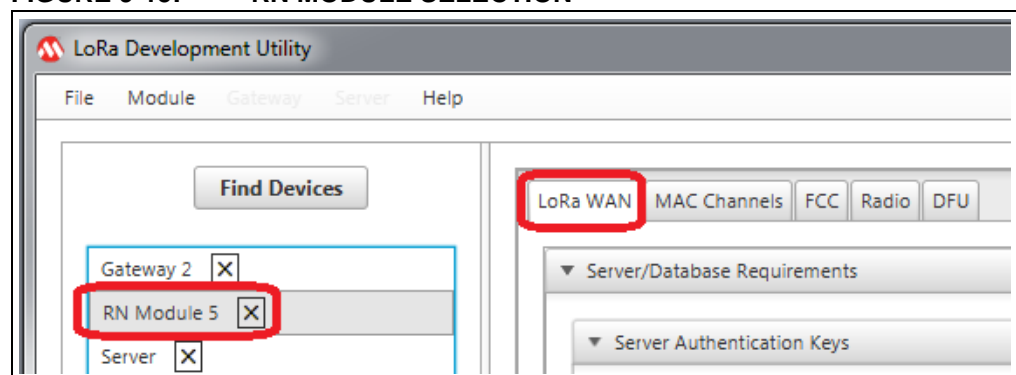

- Press **Join** push button ([Figure 9-16](#))
- Observe Status in Console ([Figure 9-16](#))

FIGURE 9-16: SUCCESSFUL OTAA JOIN

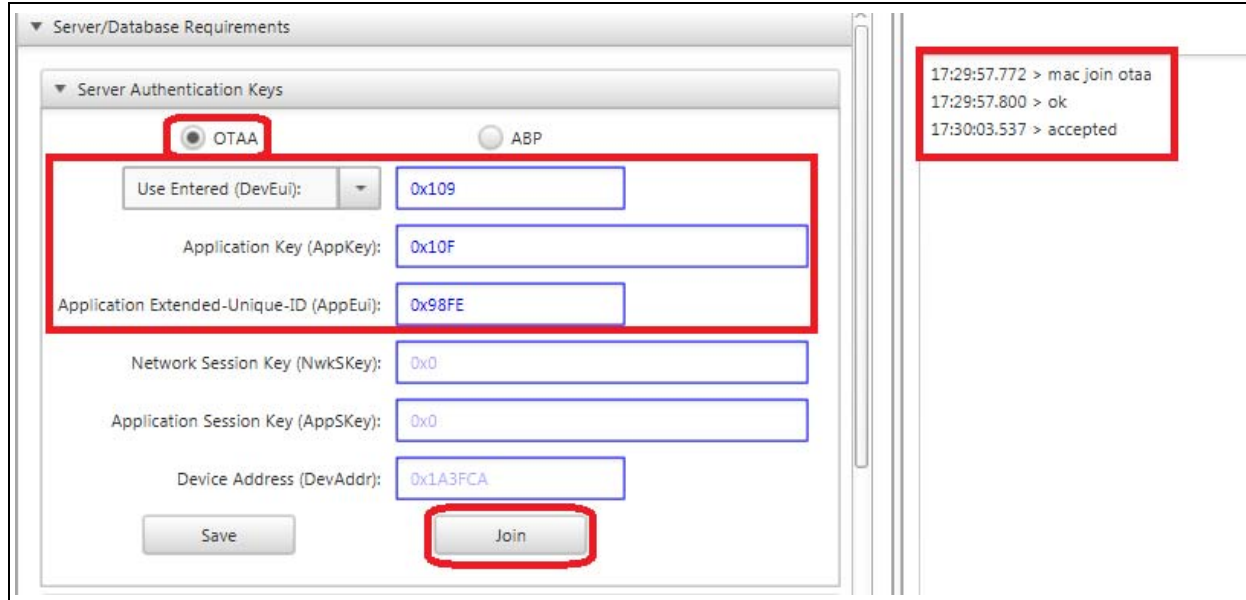

Once parameter values have been saved, the user can press **Join** to allow LoRaWAN based communication.

9.7 ISSUE UNCONFIRMED UPLINK USING OTAA PERSONALIZATION

Purpose

This will issue an unconfirmed Uplink Message to a Server Application using unique OTAA credentials.

Objectives

- Select same RN Module from Device List configured in [Section 9.6 “Join Server Using OTAA Credentials”](#)
- Select **LoRaWAN** Tab ([Figure 9-17](#))

FIGURE 9-17: RN MODULE SELECTION

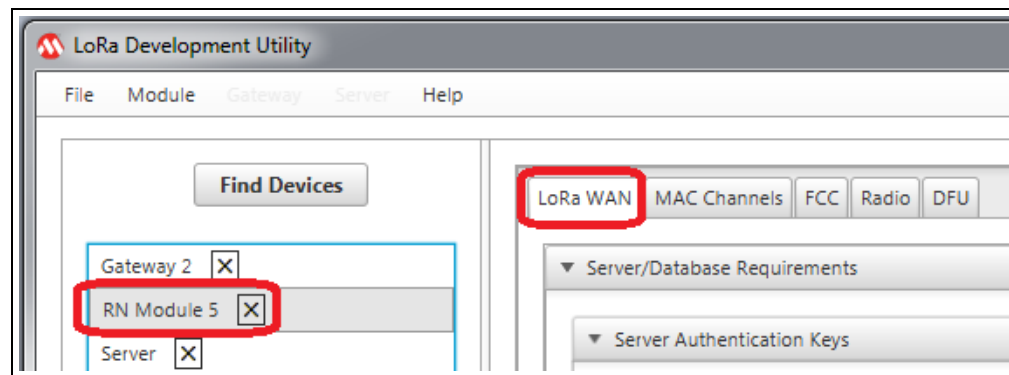

- Configure Communication Parameters ([Figure 9-18](#))
 - Port: 202
 - Confirmed: Unchecked (False)
 - ANCI: Checked (True)
 - Payload: OTAA Uplink
- Press **Transmit Uplink** push button ([Figure 9-18](#))

Over-The-Air Example Implementation

FIGURE 9-18: ISSUE UNCONFIRMED OTAA STRING UPLINK

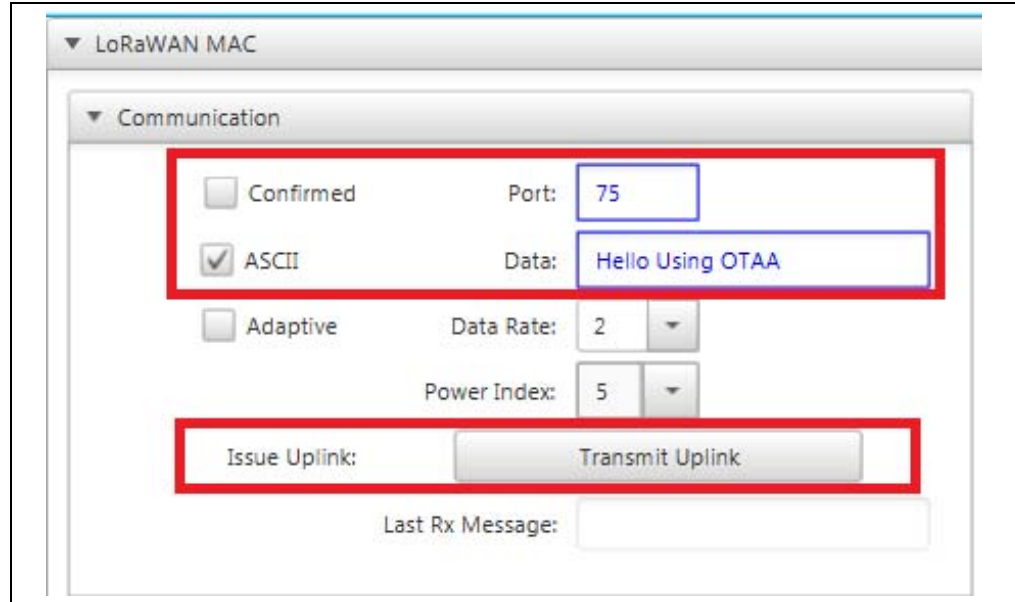

Description

After the proper authentication keys have been configured in the RN Module it is ready to issue an Uplink transmission. Under the Communication titled pane in the LoRa MAC Control box the Uplink settings and payload can be specified. This process is done that same as previously described in [Section 5.4 “Configure RN Module for Auto-Create Personalization”](#).

9.8 CONFIRM GATEWAY CAPTURE

Purpose

This confirms the Gateway received the Uplink.

Objectives

- Select **Gateway** from Device List ([Figure 9-19](#))

FIGURE 9-19: GATEWAY SELECTION

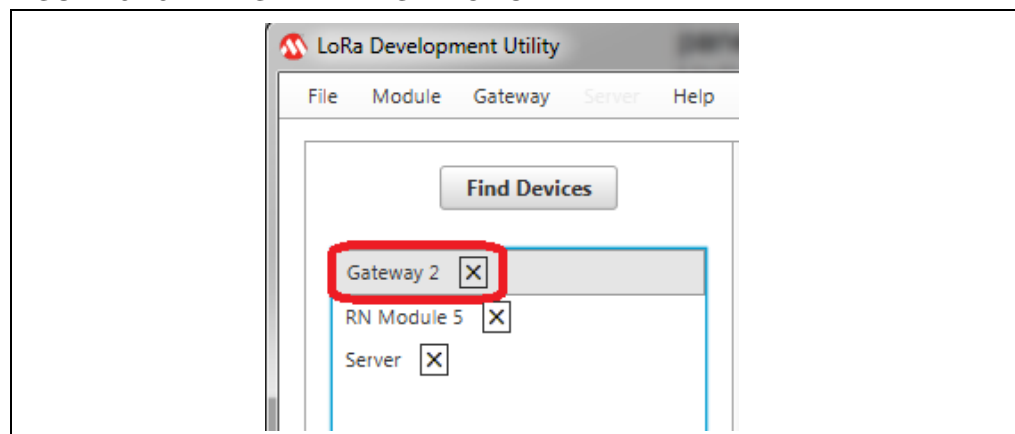

- Confirm Polling Request is occurring per [Section Figure 5-3: “Configuration Utility”](#)
- Confirm **Packets Received** has increased ([Figure 9-20](#))

FIGURE 9-20: POLLING CONFIRMATION

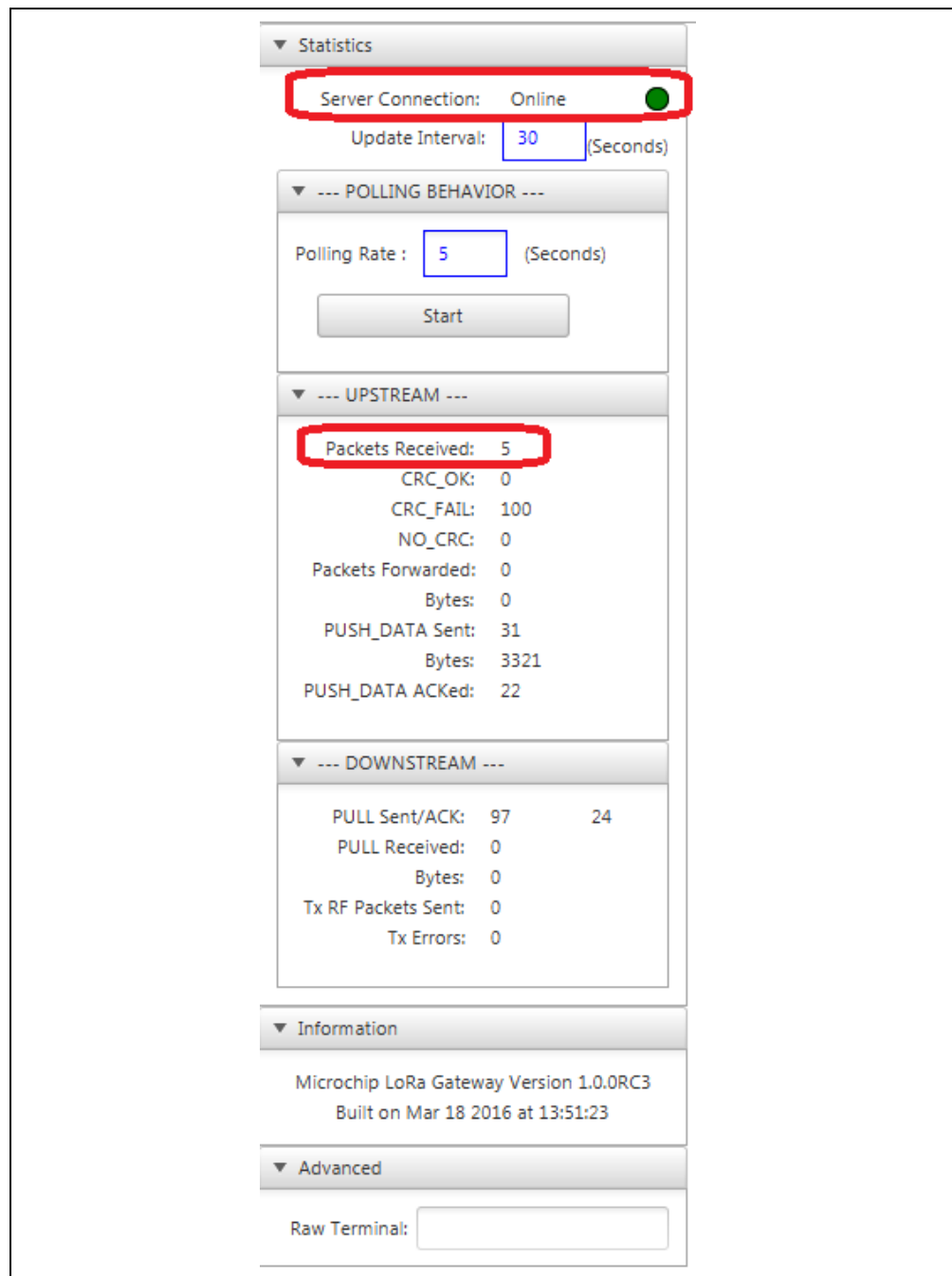

Description

With the Gateway Polling Request running, a `sys get report` command is issued from the Utility to the Gateway at the rate (in Seconds) is specified through the text field. Because the Utility is threaded, the Utility will request report information even if the Gateway is not currently selected in the Device List.

9.9 VIEW UPLINK IN DATABASE

Purpose

This confirms the Uplink was received and processed by Server.

Objectives

- Select **Server** from Device List (Figure 9-21)

FIGURE 9-21: SERVER SELECTION

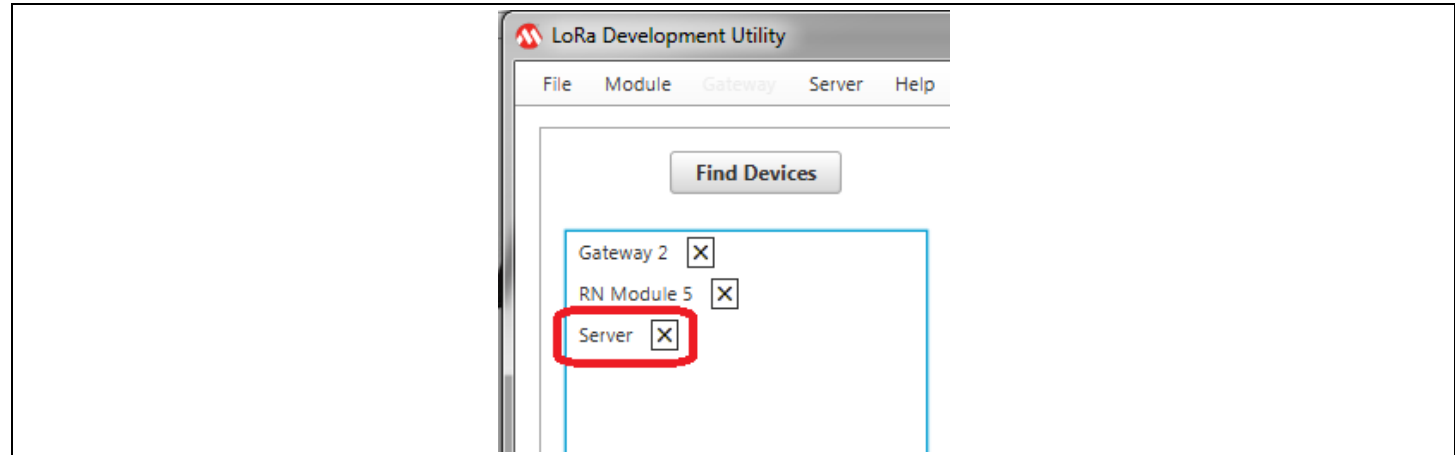

- Select **Database** Tab (Figure 9-22)
- Select **Application Data** from combo box (Figure 9-22)

FIGURE 9-22: DISPLAY APPLICATION DATA

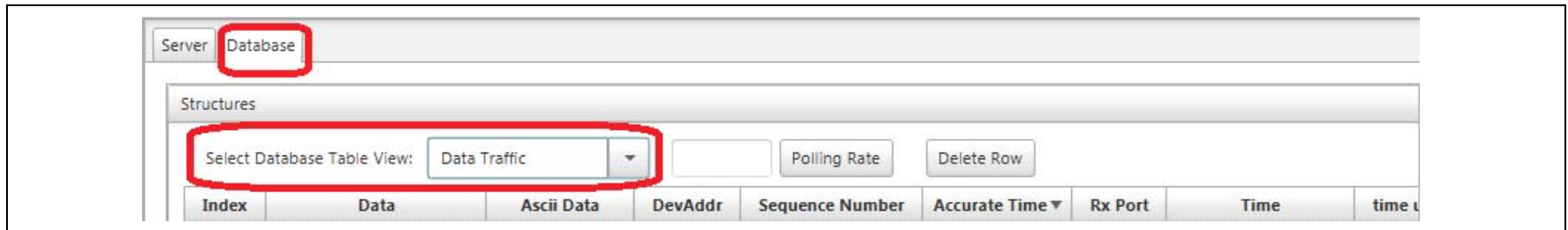

- Confirm added row from DevEUI 0x809 (Figure 9-23)

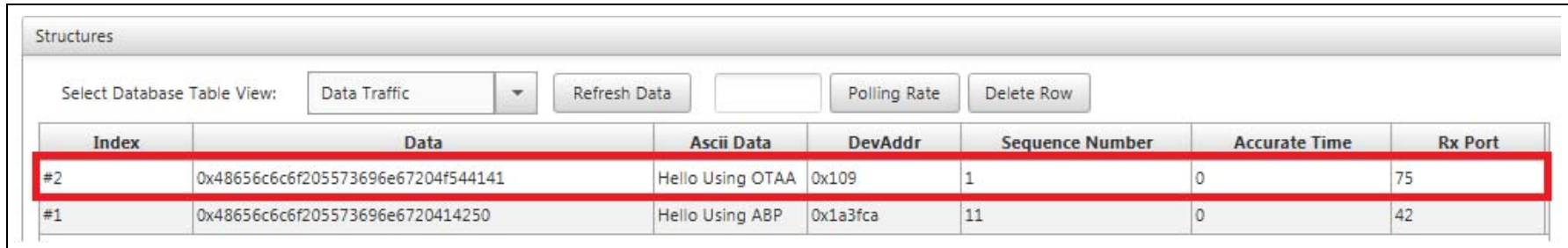
FIGURE 9-23: CAPTURE CONFIRMED

Index	Data	Ascii Data	DevAddr	Sequence Number	Accurate Time	Rx Port
#2	0x48656c6c6f205573696e67204f544141	Hello Using OTAA	0x109	1	0	75
#1	0x48656c6c6f205573696e6720414250	Hello Using ABP	0x1a3fca	11	0	42

Description

With the MySQL IP Address configured, the LoRa Development Utility should now be able to gain access to the Database. In the Server Device Model, select the **Database** tab to view different table view displays. The table information is refreshed upon use of the Database View combo box, tab selection, or automatically at the rate specified when Polling is enabled.

Chapter 10. Queue Downlink For an End Device

10.1 QUEUE DOWNLINK

Purpose

This will queue up a Downlink Message to be issued to the specified End Device upon the next Confirmed Uplink it issues.

Objectives

- Select **Server** in the Device List (Figure 10-1)

FIGURE 10-1: SERVER SELECTION

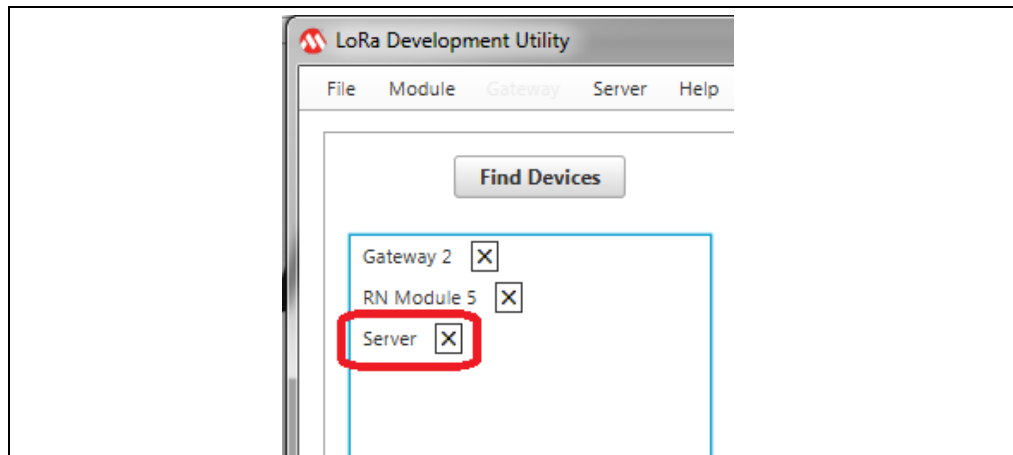

- Select **Server** Tab (Figure 10-2)
- Configure Queue End Device Downlink field parameters (Figure 10-2)
 - Device Address (DevAddr): 0x42
 - Downlink Port #: 75
 - Payload: 0x55
- Press **Queue Downlink Message** push button (Figure 10-2)

FIGURE 10-2: QUEUE DOWNLINK MESSAGE

The screenshot displays the 'Server' tab of the LoRa Technology Evaluation Suite. The interface is divided into two main sections: 'Server/Database Operation' and 'End Device Actions'. The 'End Device Actions' section is further divided into 'Provisioned (ABP)', 'Non-provisioned (OTAA)', and 'Queue End Device Downlink'. The 'Queue End Device Downlink' section is highlighted with a red border and contains the following fields: 'Device Address (DevAddr): 0x42', 'Downlink Port #: 75', and 'Payload Message: 0x55'. A 'Queue Downlink Message' button is located below these fields. The 'Server/Database Operation' section includes a 'Database Connection' pane with a 'MySQL IP Address' field set to '198.168.1.1' and a 'Connect to IP' button. It also has a 'Servers Version' pane showing 'Network Server: R2.1.1', 'Application Server: R2.1.1', and 'Customer Server: R2.1.1'. The 'Server Application' pane includes fields for 'Application Extended-Unique-Id (AppEUI): EUI', 'Server Application Name: Name', and 'Server Application Owner: Owner', with an 'Insert/Update in Database' button.

Description

It is possible to queue Downlink Messages to be issued to valid devices which have joined the LoRaWAN network, regardless if it has done so through Auto-Create, Provisioned (ABP), or Non-Provisioned (OTAA) Personalization. Queued Downlink Message can be configured to be issued to a LoRaWAN network joined Device Address (DevAddr) using the specified port number, to transmit the designated Payload Message upon the End Device's next Confirmed Uplink.

Queued Downlink Messages can be setup using the LoRa Development Utility. From the Server Device Model, under the **Server** tab is the titled pane Queue End Device Downlink contained within the End Device Actions titled pane. Inside Queue End Device Downlink are three text fields used to configure the Downlink Message. The text fields must be configured with parameter values prior to pressing the **Queue Downlink Message** push button, see [Figure 10-3](#). Upon doing this, a MySQL command will be issued to insert the Downlink Message into the database. Once successfully inserted, a UDP message will be sent by the LoRa Development Utility to the LoRa Server to make it aware of the new queue message.

FIGURE 10-3: QUEUING DOWNLINK MESSAGES

The screenshot displays a web-based configuration interface for queuing downlink messages. It is organized into three main sections:

- Provisioned (ABP):** Contains input fields for 'Device Address (DevAddr)', 'Network Session Key (NwkSKey)', and 'Application Session Key (AppSKey)', with an 'Insert/Update in Database' button below.
- Non-provisioned (OTAA):** Contains a 'Server Application EUI' dropdown menu (set to 'Select EUI'), an 'Application Key (AppKey)' field, and a 'Device Extended-Unique-Id (DevEUI)' field, with an 'Insert/Update in Database' button below.
- Queue End Device Downlink:** Contains three input fields: 'Device Address (DevAddr): 0x42' (highlighted with a red border), 'Downlink Port #: 75' (highlighted with a blue border), and 'Payload Message: 0x55' (highlighted with a green border). A 'Queue Downlink Message' button (highlighted with a purple border) is located below these fields.

On the right side of the interface, a log entry is visible: `17:45:26.674 > Queue Message for: 42 on PortNumber: 75 with Payload: 55`. The values 42, 75, and 55 in this log entry correspond to the values entered in the 'Queue End Device Downlink' section.

LoRa[®] Technology Evaluation Suite User's Guide

NOTES:

Chapter 11. Receiving Queued Downlink Messages

11.1 RECONFIGURE RN MODULE FOR ABP

Purpose

Confirm RN Module is configured with credentials created in [Chapter 8. "Activation-By-Personalization \(ABP\) Example Implementation"](#).

Objectives

- Select **RN Module** from the Device List ([Figure 11-1](#))
- Select **LoRaWAN** Tab ([Figure 11-1](#))

FIGURE 11-1: RN MODULE SELECTION

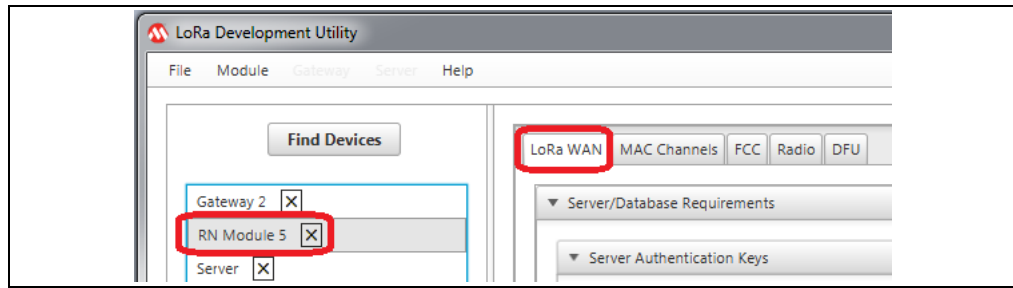

- Configure Server Authorization Keys field parameters ([Figure 11-2](#))
 - Network Session Key (NwkSKey): 0x99
 - Application Session Key (AppSKey): 0x87
 - Device Address (DevAddr): 0x42
- Press **Save** push button ([Figure 11-2](#))
- Press **Join** push button ([Figure 11-2](#))

FIGURE 11-2: RN MODULE ABP JOIN

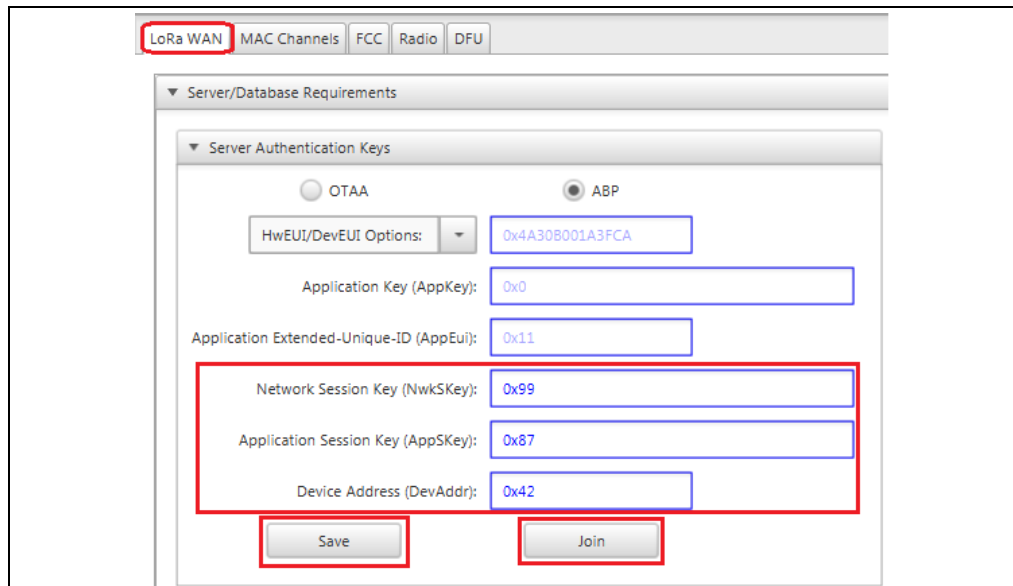

Description

Once a Downlink Message has been queued into the LoRa Server, it will be transmitted by the LoRa Server upon the next Confirmed Uplink received from the Device Address (DevAddr) specified. After transmission of Confirmed Uplink packet, the End Device will open its two receive windows at the configured time.

The Downlink Message should be sent by the server during these time periods. Once the End Device successfully received the Downlink Message the RN Module Console will display 'mac_rx <portNumber> <data>'.
'

Confirmed packets can be transmitted by the end devices in a wide number of ways. This includes taking direct CDC commands from a Serial Terminal program, issued from a mobile End Device as instructed by a Host Microcontroller, or by doing so through the LoRa Development Utility, to name a few methods. Through the LoRa Development Utility, the user can select from the Device List which of the connected RN Modules they wish to issue an Uplink from. Under the **LoRaWAN** tab is the titled pane Communication inside LoRa MAC Control pane, from here we can issue an Uplink Message just as before. However, this time we will want to make sure to check the Confirmed checkbox.

11.2 ISSUE CONFIRMED UPLINK

Purpose

Issue a Confirmed Uplink to trigger Downlink.

Objectives

- Select **RN Module** from the Device List configured in [Section 11.1 “Reconfigure RN Module for ABP”](#)
- Select **LoRaWAN** Tab ([Figure 11-3](#))

FIGURE 11-3: RN MODULE SELECTION

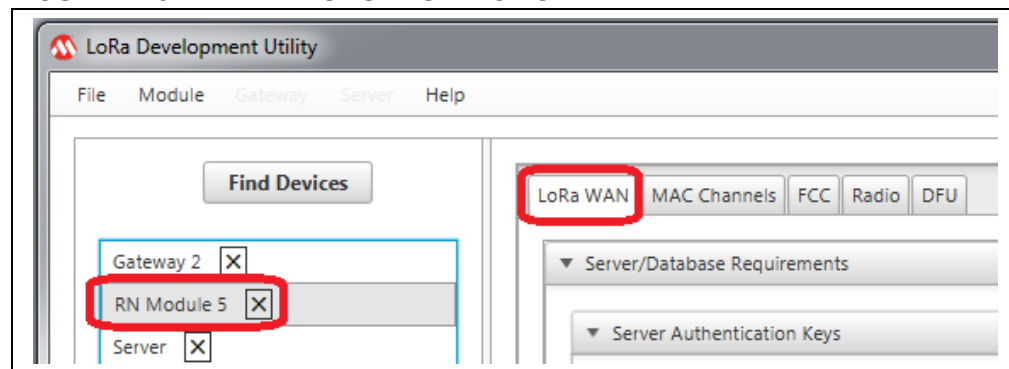

- Configure Communication Parameters ([Figure 11-4](#))
 - Port: 31
 - Confirmed: Checked (True)
 - ANCI: Checked (True)
 - Payload: I Expect a Downlink
- Press **Transmit Uplink** push button ([Figure 11-4](#))

Receiving Queued Downlink Messages

FIGURE 11-4: ISSUE CONFIRMED ABP STRING UPLINK

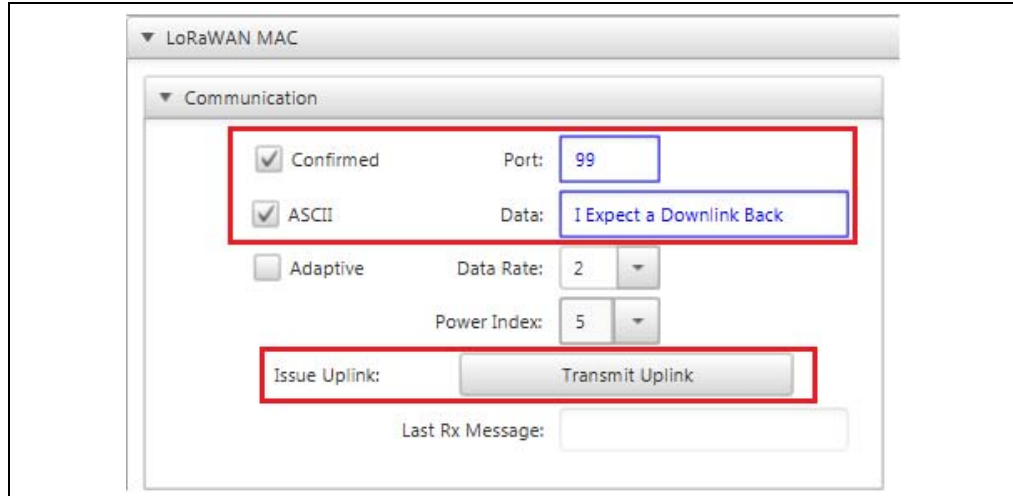

Description

With the Gateway Polling Request running, a `sys get report` command is issued from the Utility to the Gateway at the rate (in seconds) is specified through the text field. Because the Utility is threaded, the Utility will request report information even if the Gateway is not currently selected in the Device List.

11.3 OBSERVE DOWNLINK RESPONSE

Purpose

Confirm reception of Downlink Payload 0x55, through Port 75 triggered by end devices Confirmed Uplink.

Objectives

- Select **RN Module** from the Device List configured in [Section 11.1 “Reconfigure RN Module for ABP”](#)
- Select **LoRaWAN** Tab ([Figure 11-5](#))

FIGURE 11-5: RN MODULE SELECTION

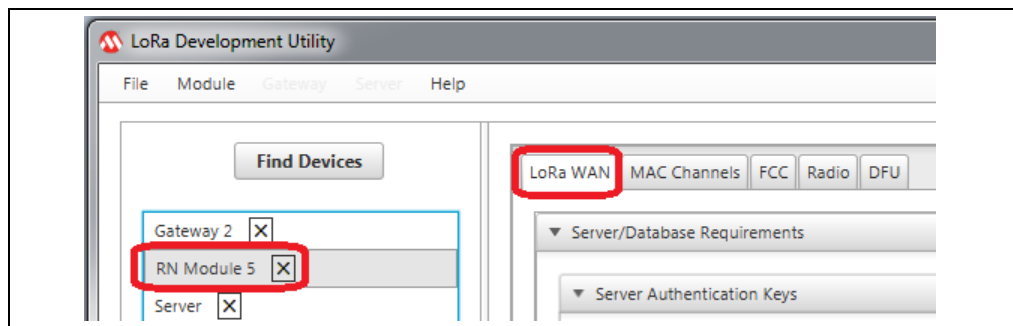

- Observe text (0x55) populated inside Received Downlink text field located inside the Communication titled pane
- Observe text in RN Module Console indicating “`mac_rx 75 55`”

FIGURE 11-6: VIEW DOWNLINK MESSAGE

The screenshot shows the 'LoRaWAN MAC' configuration window, specifically the 'Communication' tab. The 'Confirmed' checkbox is checked, and the 'Data' field contains the text 'I Expect a Downlink Back'. The 'Port' is set to 99, 'Data Rate' is 2, and 'Power Index' is 5. A 'Transmit Uplink' button is visible. The 'Last Rx Message' field at the bottom is highlighted with a red border and contains the hexadecimal value '0x55'.

Description

After transmission of a Confirmed Uplink packet, the End Device will wait for the expected Downlink response. If issued using the LoRa Development Utility, once captured the RN Module Console will display "mac_rx" followed by the Downlink Message and port number the Downlink was received upon. The text field Last Rx Message will then be populated with the payload of the received Downlink.

Chapter 12. RN Modules

12.1 OVERVIEW

Through use of the LoRa Development Utility it is possible to exercise every command supported by the current RN Module firmware through a visual interface. This allows those that have a good understanding of the LoRa system to configure and evaluate end-device behavior without any knowledge of the ASCII command structures.

Additionally, it is possible to execute Device Firmware Updates to any connected RN Modules, to ensure that all end devices being used have the latest build of the LoRaWAN application code.

12.2 FEATURES

The RN Module model view has been broken into multiple tab panes for a more comprehensive display, with an easy-to-navigate layout. Each specific tab pane contains multiple titled panels which can be collapsed when no longer required to improve visual presentation. The Utility is capable of distinguishing between RN Module types (868/915 MHz), modifying the available configurations or test options appropriately. Specifics of the difference can be found under [Section 12.3 “Description”](#) contained within this chapter.

[Figure 12-1](#) depicts the available tabs for the RN Module:

1. LoRaWAN Behavior
2. MAC Channels
3. FCC Test
4. Radio Behavior
5. Device Firmware Update

FIGURE 12-1: RN MODULE TABS

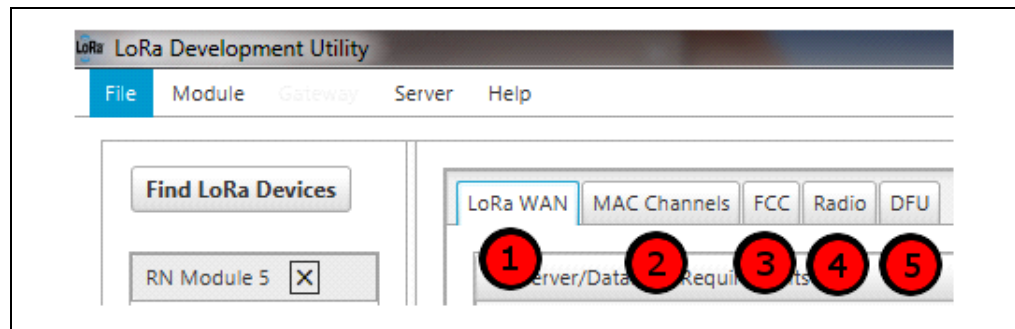

12.3 DESCRIPTION

After selecting a RN Module from the Device List, the model viewer will become populated with the appropriate fields. For Boolean-based inputs, checkboxes are used. When multiple defined values are available, combo boxes with the appropriate inputs are used. Text fields contain validators to help visual indicate if the current value entered into the text field is valid. Values entered into text fields will be front padded with 0's upon command execution (e.g., if a value of 0x123 is entered as the DevEUI, when issued in the command, the value will be formatted as 0x00000000000123). This is to ensure proper format when communicating commands to the RN Module.

All titled panes are collapsible by clicking on them. Checkboxes and combo boxes will issue the expected commands to the RN Modules upon selection. Text fields will issue the command when the **Enter/Return** key is pressed on the PC. In some cases, a push button may issue multiple commands. Refer to the descriptions of each element for details on the expected behavior.

12.3.1 LoRaWAN Tab Descriptions

Below are the interactive elements of the **LoRaWAN** tab inside the RN Module Device Model, as represented in [Figure 12-2](#):

1. Database/Server Requirements titled pane
2. Server Authentication Keys titled pane
3. Network Joining Method
4. Hardware/Device Extended-Unique-Identifier
5. Application Key
6. Application Extended-Unique-Identifier
7. Network Session Key
8. Application Session Key
9. Device Address
10. Save
11. Join
12. Database Authentication
13. Configure for Default Application Server
14. Database SQL Local Host Assignment
15. Custom Database SQL IP Location Assignment
16. Add to Module to SQL Database
17. LoRa MAC Control titled pane
18. LoRaWAN Protocol titled pane
19. Confirmed Uplink Status
20. Next Uplink issued Port Number
21. Uplink Data ASCII format Status
22. Uplink Data
23. Adaptive Data Rate Status
24. LoRaWAN Data Rate
25. LoRaWAN Power Index
26. Issue Uplink
27. Last received Downlink Message
28. LoRaWAN Settings titled pane
29. LoRaWAN Automatic Replay status
30. Battery Level
31. Link Check

32. Receive Delay Window 1
33. Receive Delay Window 2
34. Retransmission Attempts
35. LoRaWAN Sync Word
36. MAC Control titled pane
37. MAC Pause/Resume
38. MAC Reset
39. MAC Force Enable
40. Emulated Serial Terminal titled pane
41. Raw Serial Command
42. Issue Command
43. Information titled pane
44. Module Version and Build information

FIGURE 12-2: RN MODULE LoRaWAN™ TAB LAYOUT

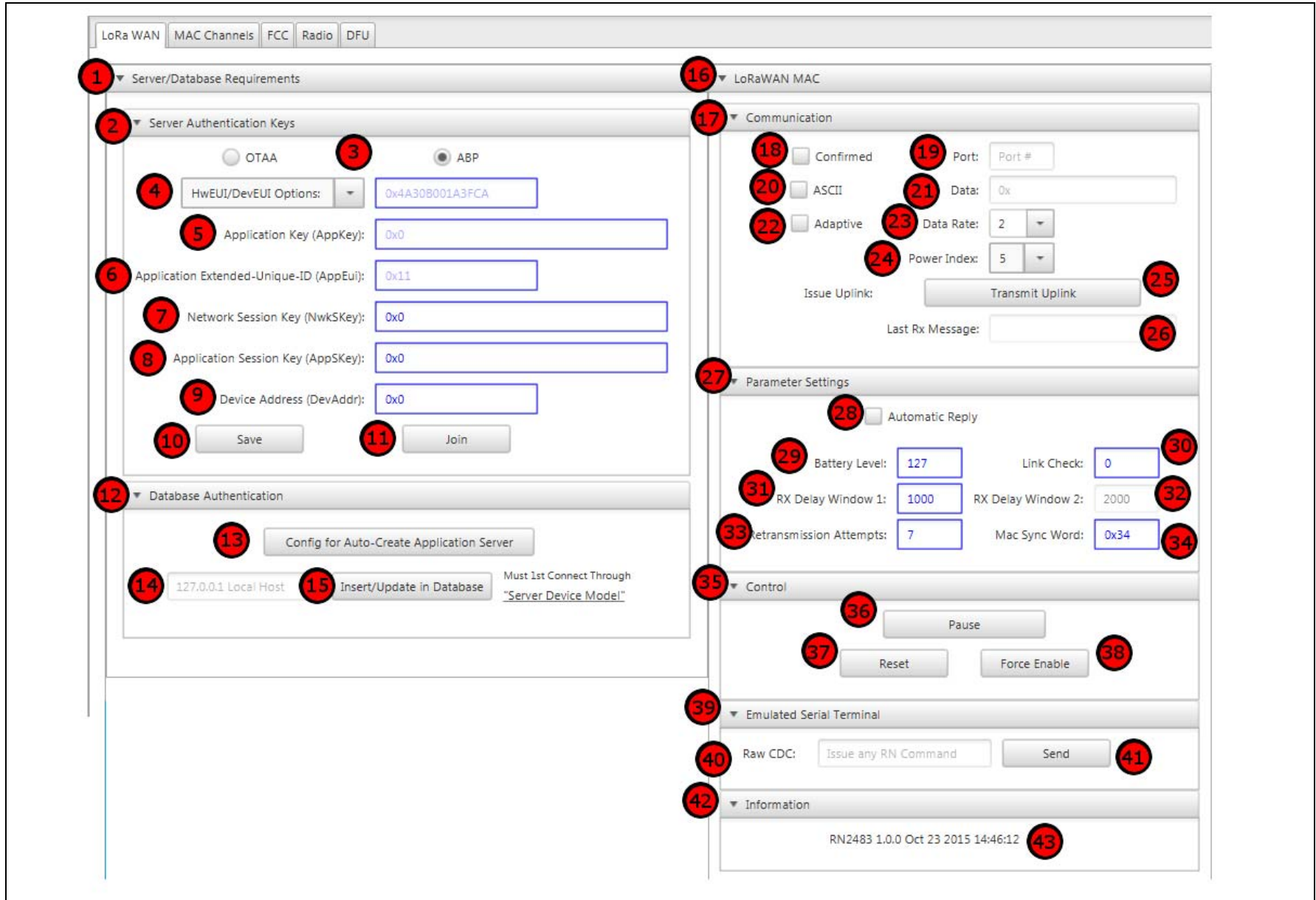

Database/Server Requirements

FIGURE 12-3: SERVER/DATABASE REQUIREMENTS PANE

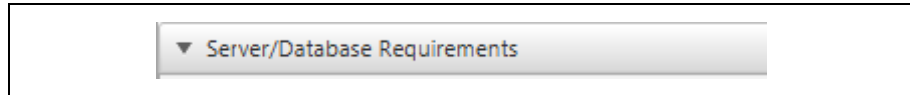

Description

Collapsible titled pane (Figure 12-3) containing all Server interaction related commands requirements, and database interaction extensions available from the RN Module GUI model.

Execution Conditions

- Left click on field

Server Authentication Keys

FIGURE 12-4: SERVER AUTHENTICATION KEYS PANE

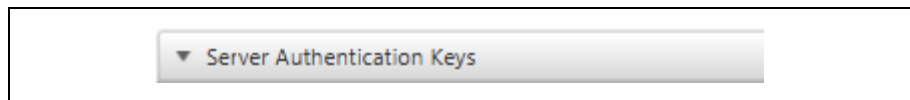

Description

Collapsible titled pane (Figure 12-4) containing all network joining and authorization command handling.

Execution Conditions

- Left click on field

Network Joining Method

FIGURE 12-5: NETWORK JOINING RADIO BUTTONS



Description

Radio button option selection for method of network activation (Figure 12-5). Selection of type will enable required authentication key fields, while disabling those not applicable.

Available Options

- ABP
- OTAA

Execution Conditions

- Left click on **Radio Button** bubble, determines <joinType>

Hardware/Device Extended-Unique-Identifier

FIGURE 12-6: HARDWARE/DEVICE EXTENDED-UNIQUE-IDENTIFIER COMBO-BOX



Description

Combo box gives the ability to choose to use either the Hardware Extended-Unique-Identifier uniquely supplied by the RN Module as the DevEUI, or a custom configure value specified by the user (Figure 12-6). Customized DevEUI's are not guaranteed to be unique, and it is the Network owner's responsibility to ensure no repeated DevEUI's are used. The text field can either have an 8-byte hexadecimal value entered to be used for Device Extended-Unique-Identifier, or displays the RN Modules HwEUI which is used as the DevEUI when joining an OTAA network.

Combo Box Options

TABLE 12-1: COMBO-BOX OPTIONS

Box Selection	Description
Use RN Module (HwEui)	RN Module Hardware EUI is used
Use Entered (DevEUI)	Custom Device EUI is used

Expected Value Format

- 0x0 – 0xFFFFFFFFFFFFFFFF [8-byte Hexadecimal]

Execution Condition

- Combo box selection
- Issues Command at when **Enter** is pressed in Text Field
- **Save** button is pressed with **OTAA** radio button selected

Module Commands

- `mac get hweui`
- `mac set deveui <DevEUI>`

Application Key

FIGURE 12-7: AppKey TEXT FIELD

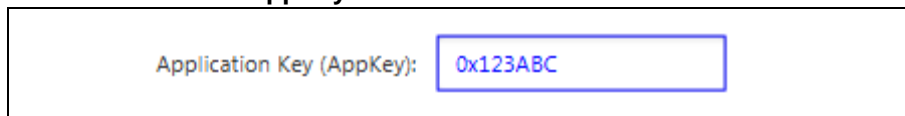

Description

Text field where the Application Key used for OTAA networking joining is specified (Figure 12-7). Currently stored Application Key cannot be read from the RN Module and thus 0x0 will be shown in the text field by default.

Expected Value Format

- 0x0 – 0xFFFFFFFFFFFFFFFF [16-byte Hexadecimal]

Execution Conditions

- Issues Command at when **Enter** is pressed in Text Field
- **Save** button is pressed with **OTAA** radio button selected

Module Commands

- `mac set appkey <AppKey>`

Application Extended-Unique-Identifier

FIGURE 12-8: AppEUI TEXT FIELD

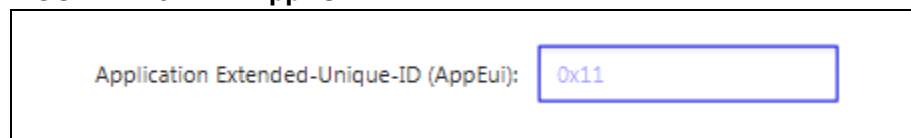

Description

Text field where the Application Extended-Unique-Identifier used for OTAA networking joining is specified (Figure 12-8). By default, the field will be populated with the Application Extended-Unique-Identifier stored on the RN Module.

Expected Value Format

- 0x0 – 0xFFFFFFFFFFFFFFFF [8-byte Hexadecimal]

Execution Conditions

- Issues Command at when **Enter** is pressed in Text Field
- **Save** button is pressed with **OTAA** radio button selected

Module Commands

- `mac set appeui <AppEui>`

Network Session Key

FIGURE 12-9: NwkSKey TEXT FIELD

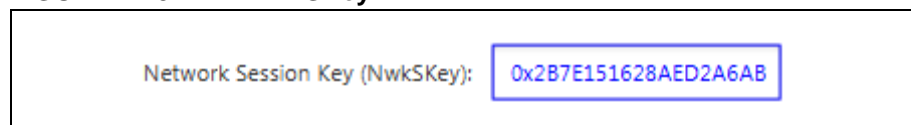

Description

Text field where the Network Session Key used for ABP networking joining is specified (Figure 12-9). Currently stored Network Session Key cannot be read from the RN Module and thus 0x0 will be shown in the text field by default.

Expected Value Format

- 0x0 – 0xFFFFFFFFFFFFFFFFFFFFFFFFFFFFFFFF [16-byte Hexadecimal]

Execution conditions

- Issues Command at when **Enter** is pressed in Text Field
- **Save** button is pressed with **ABP** radio button selected

Module Commands

- `mac set nwkskey <NwkSKey>`

Application Session key

FIGURE 12-10: AppSKey TEXT FIELD

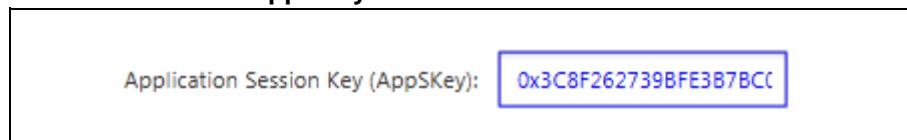

Application Session Key (AppSKey): 0x3C8F262739BFE3B7BC

Description

Text field where the Application Session Key used for ABP networking joining is specified (Figure 12-10). Currently stored Application Session Key cannot be read from the RN Module and thus 0x0 will be shown in the text field by default.

Expected Value Format

- 0x0 – 0xFFFFFFFFFFFFFFFFFFFFFFFFFFFFFFFF [16-byte Hexadecimal]

Execution conditions

- Issues Command at when **Enter** is pressed in Text Field
- **Save** button is pressed with **ABP** radio button selected

Module Commands

- `mac set appskey <AppSKey>`

Device Address

FIGURE 12-11: DevAddr TEXT FIELD



Device Address (DevAddr): 0x1A8C44

Description

Text field where the Device Address used for ABP networking joining is specified (Figure 12-11). Currently stored Application Session Key cannot be read from the RN Module and thus 0x0 will be shown in the text field by default.

Expected Value Format

- 0x0 – 0xFFFFFFFF [4-byte Hexadecimal]

Execution conditions

- Issues Command at when **Enter** is pressed in Text Field
- **Save** button is pressed with **ABP** radio button selected

Module Commands

- `mac set appskey <AppSKey>`

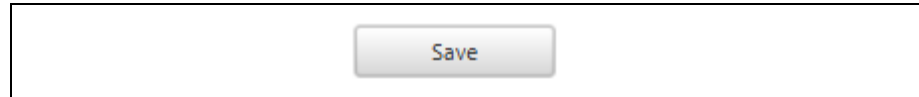
Save**FIGURE 12-12: SAVE PUSH BUTTON****Description**

Issue a `SAVE` command to the RN Module (Figure 12-12). In addition, the GUI will also ensure to send the commands necessary to configure all Authorization Keys required to join the currently selected network joining method. Thus, clicking the **Save** button while ABP is selected will result in the Network Session Key, Application Session Key, and Device Address being configured prior to the save commands execution.

Execution conditions

- Left click on button with either **ABP** or **OTAA** joining method selected

Module Commands

- ABP
 - `mac set nwkskey 0x123`
 - `mac set appskey 0xABC`
 - `mac set devaddr 0x89FE`
 - `mac save`
- OTAA
 - `mac set deveui 0x789`
 - `mac set appeui 0xDEF`
 - `mac set appkey 0x1122`
 - `mac save`

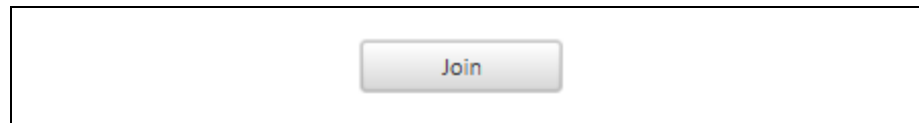
Join**FIGURE 12-13: JOIN PUSH BUTTON****Description**

Issue a `JOIN` command to the RN Module based upon the currently selected network activation method (Figure 12-13).

Execution conditions

- Left click on button with either **ABP** or **OTAA** joining method selected

Module Commands

- `mac join <joinType>`

Database Authentication

FIGURE 12-14: DATA AUTHENTICATION TITLED PANE

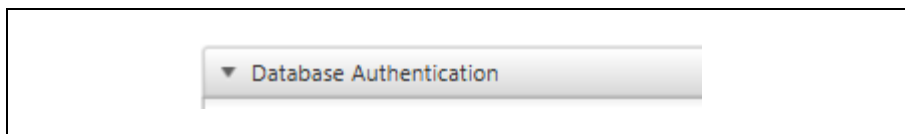

Description

Collapsible titled pane containing non-LoRaWAN related actions (Figure 12-14). This pane contains features implemented on the LoRa Development Suite which are related to the example LoRa Servers used with the suite, along with SQL communication for database manipulation.

Execution conditions

- Left click on field

Configure for Default Application Server

FIGURE 12-15: MICROCHIP DEFAULT SERVER PUSH BUTTON

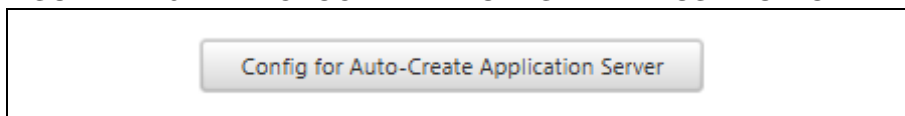

Description

This push button is used to configure the connected RN Module for the default Application server included with the LoRa Development Suite (Figure 12-15). This button will automatically populate the Network Session Key and Application Session Key text fields with pre-authorized keys for an ABP network join. The Device Address is automatically generated from the lower four bytes taken from the RN Modules Hardware Extended-Unique-Identifier.

Execution conditions

- Left click on the button

Note: Pressing the button will only populate the fields, and does not SAVE, or JOIN automatically.

Custom Database SQL IP Location Assignment

FIGURE 12-16: CUSTOM IP TEXT FIELD

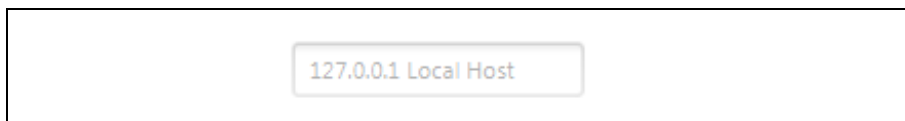

Description

Modify the SQL Database being used is NOT locally hosted, a specified IP Address is required (Figure 12-16). Server is locally hosted through Docker; this field can be left blank. Local Host IP 127.0.0.1 will be used.

Execution conditions

- Updates Model when **Enter** is pressed in Text Field
- Press **Add to Database** push button

Add Module to SQL Database

FIGURE 12-17: ADD TO DATABASE PUSH BUTTON



Description

This push button is used to issue a request to modify the LoRa SQL Database at the specified IP Address (Figure 12-17). Pressing this button will result in an **SQL Insert**, or **Update** action being requested to the specified IP Address. Depending upon activation method selected, either the **ABP** Devices or **OTAA** Devices table will be modified.

Execution conditions

- Left click on button with either **ABP** or **OTAA** joining method selected.

SQL Action

- Insert/Update a Provisioned (**ABP**) or Non-Provisioned (**OTAA**) in the database

LoRa® MAC Control Titled Pane

FIGURE 12-18: LoRa® MAC TITLED PANE

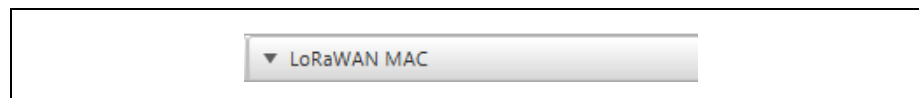

Description

Collapsible titled pane (Figure 12-18) containing all configuration setting pertaining to the LoRaWAN Media Access Control (MAC) parameters, setting and network communication.

Execution conditions

- Left click on field

LoRaWAN™ Protocol Titled Pane

FIGURE 12-19: LoRaWAN™ PROTOCOL TITLED PANE

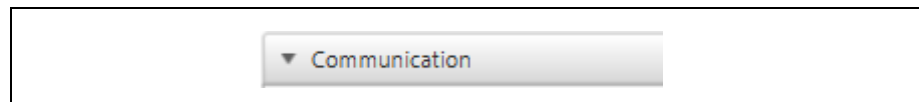

Description

Collapsible titled pane (Figure 12-19) containing the ability to issue LoRaWAN transmissions after network joining, along with the ability to modify parameter values for improved communication performance.

Execution conditions

- Left click on field

Confirmed Uplink Status

FIGURE 12-20: CONFIRMED UPLINK CHECKBOX

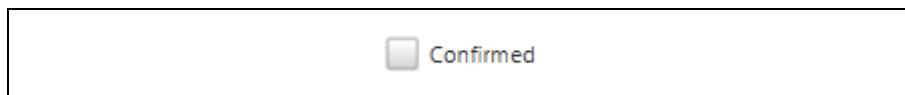

Description

The <cnfStatus> checkbox when toggled will ensure the next issued Uplink Message from the Communication titled pane will be a Confirmed Message (Figure 12-20), and so the LoRaWAN will expect a Downlink response from the network. When this box is not checked, the next Uplink Message from the Communication titled pane will be Unconfirmed, and no Downlink Message will be expected.

Execution conditions

- Left click on box to alter next Uplink Messages Status

Next Uplink Issued Port Number

FIGURE 12-21: UPLINK PORT NUMBER TEXT FIELD

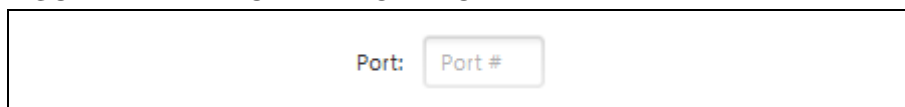

Description

The <portNumber> text field (Figure 12-21) is used to write the next Port Number used for the next Uplink Message issued from the Communication titled pane.

Execution conditions

- Updates Model when **Enter** is pressed in Text Field
- Press **Issue Uplink** push button

Uplink Data ASCII Format Status

FIGURE 12-22: ASCII PAYLOAD CHECKBOX



Description

This check box is used to indicate the next Data to be send via Uplink Message is a string (Figure 12-22). The GUI will automatically convert the message to the proper form before issuing the Uplink Message.

Execution conditions

- Updates Model when **Enter** is pressed in Text Field
- Press **Issue Uplink** push button

Uplink Data

FIGURE 12-23: UPLINK PAYLOAD

The screenshot shows a rectangular box containing the text 'Data: Uplink Data'. The text 'Uplink Data' is enclosed in a light gray rounded rectangular field, suggesting it is an input or display field.

Description

The <dataPayload> text field (Figure 12-23) is used for the Data Payload which will be issued with the next requested Uplink Message from the **Communication** titled pane.

Execution conditions

- Press **Issue Uplink** push button

Module Commands

- `mac tx <cnfStatus> < dataPayload >`

Adaptive Data Rate Status

FIGURE 12-24: ADR CHECKBOX

The screenshot shows a rectangular box containing a checkbox followed by the text 'Adaptive'. The checkbox is currently unchecked.

Description

The <adrStatus> checkbox is used to enable/disable the Adaptive Data Rate feature implemented on the LoRaWAN (Figure 12-24).

Execution conditions

- Left click on box to alter <adrStatus> between On/Off.

Module Commands

- `mac adr on`

LoRaWAN™ Data Rate

FIGURE 12-25: DATA RATE COMBO BOX

The screenshot shows a rectangular box containing the text 'Data Rate: 3' followed by a dropdown arrow icon. The number '3' is displayed in a small white box.

Description

This combo box (Figure 12-25) configures the currently used Data Rate when the RN Module is performing LoRaWAN related operations.

Combo Box options

- 0, 1, 2, 3, 4

Execution conditions

- Combo box selection

Module Commands

- `mac set dr 2`

LoRaWAN™ Power Index

FIGURE 12-26: POWER INDEX COMBO BOX



Description

This combo box (Figure 12-26) configures the currently used Power Index when the RN Module is performing LoRaWAN related operations.

Combo Box options

- RN2483
 - 0, 1, 2, 3, 4, 5
- RN2903
 - 5, 7, 8, 9, 10

Execution conditions

- Combo box selection

Module Commands

- `mac set pwridx 5`

Issue Uplink

FIGURE 12-27: ISSUE UPLINK PUSH BUTTON

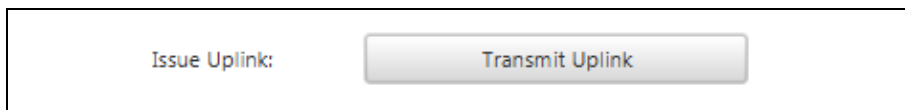

Description

This push button used to issue LoRaWAN Uplink packet according to the current Communication titled pane field configurations (Figure 12-27).

Execution conditions

- Execute Uplink according to <cnfStatus>, <portNumber>, and <dataPayload>

Module Commands

- `mac tx <cnfStatus> <portNumber> <dataPayload>`
- `mac tx uncnf 99 41424344`

Last Received Downlink Message

FIGURE 12-28: LAST RECEIVED DOWNLINK DISPLAY

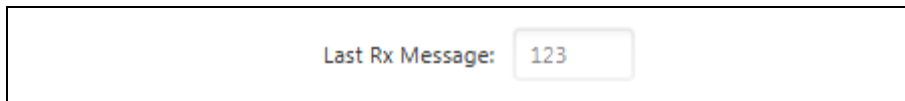

Description

Data captured from the Last Rx Message is inserted into the text field automatically after valid LoRaWAN Downlink information has been received (Figure 12-28).

Execution conditions

- Execute Uplink according to <cnfStatus>, <portNumber>, and <dataPayload>

Module Commands

- `mac tx <cnfStatus> <portNumber> <dataPayload>`
- `mac tx uncnf 99 41424344`

LoRaWAN™ Setting Titled Pane

FIGURE 12-29: LoRaWAN™ SETTING TITLED PANE

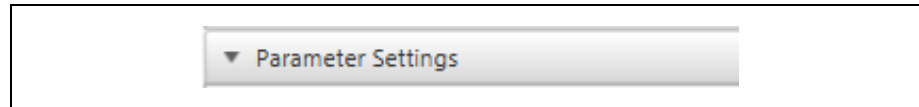

Description

Collapsible titled pane (Figure 12-29) containing all additional LoRaWAN behavior parameters and settings.

Execution conditions

- Left click on field

LoRaWAN™ Automatic Reply Status

FIGURE 12-30: AUTOMATIC REPLAY CHECKBOX

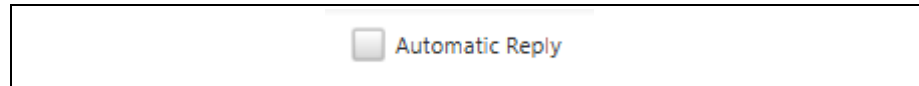

Description

The <autoReplay> checkbox is used to enable/disable the Automatic Replay feature implemented on the LoRaWAN (Figure 12-30).

Execution conditions

- Left click on box to alter <autoReplay> between On/Off

Module Commands

- `mac set ar off`

Battery Level

FIGURE 12-31: BATTERY LEVEL TEXT FIELD



Description

The <batLevel> text field (Figure 12-31) is used to configure the battery level required for a Device Status Answer frame command response to be used by the LoRaWAN.

Execution conditions

- Updates Model when **Enter** is pressed in Text Field

Module Commands

- `mac set bat 127`

Link Check

FIGURE 12-32: LINK CHECK TEXT FIELD



The screenshot shows a text input field with the label "Link Check:" and the value "0". The field is highlighted with a blue border.

Description

The <linkCheck> text field (Figure 12-32) is used to configure the time interval for a Link Check Process to be triggered within the LoRaWAN for the device.

Execution conditions

- Updates Model when **Enter** is pressed in Text Field

Module Commands

- `mac set linkchk 65000`

Receive Delay Window 1

FIGURE 12-33: RECEIVE WINDOW 1TEXT FIELD

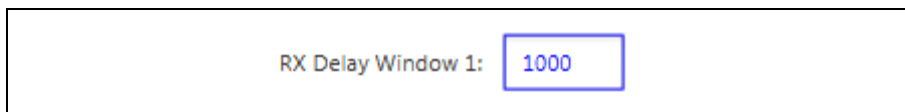

The screenshot shows a text input field with the label "RX Delay Window 1:" and the value "1000". The field is highlighted with a blue border.

Description

The <delayWindow1> text field (Figure 12-33) is used to configure the first Receive Window time length used by the End Device for expecting a Downlink Response.

Execution conditions

- Updates Model when **Enter** is pressed in Text Field

Module Commands

- `mac set rxdelay1 1000`

Receive Delay Window 2

FIGURE 12-34: RECEIVE WINDOW 2 DISPLAY

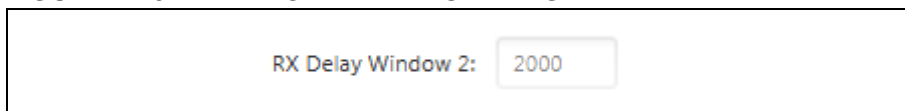

The screenshot shows a text input field with the label "RX Delay Window 2:" and the value "2000". The field is highlighted with a blue border.

Description

The <delayWindow2> text field (Figure 12-34) is used to indicate the expected second Receive Window. The second Receive window is typically based off the current first window setting.

Execution conditions

- Updates Model when **Enter** is pressed in Text Field

Module Commands

- `> mac get rxdelay2`
- `< 2000`

Retransmission Attempts

FIGURE 12-35: RETRANSMISSION ATTEMPTS TEXT FIELD

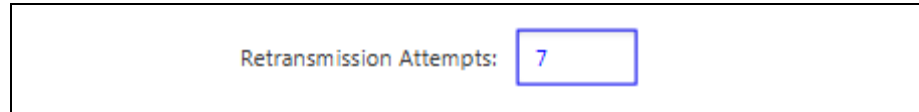

Retransmission Attempts:

Description

The <retransmitAttempts> text field (Figure 12-35) is used to configure the LoRaWAN parameters that coordinate the number of retransmission attempts done after a confirmed packet, when no Downlink Response was received.

Execution conditions

- Updates Model when **Enter** is pressed in Text Field

Module Commands

- `mac set rxtx 10`

LoRaWAN™ Sync Word

FIGURE 12-36: MAC SYNC WORD TEXT FIELD



Mac Sync Word:

Description

The <macSync> text field (Figure 12-36) is used to configure the LoRaWAN sync word used for network joining/communication. Typically, the sync word is used to determine if the LoRaWAN network is private or public.

Execution conditions

- Updates Model when **Enter** is pressed in Text Field

Module Commands

- `mac set sync 34`

Control Titled Pane

FIGURE 12-37: CONTROL TITLED PANE

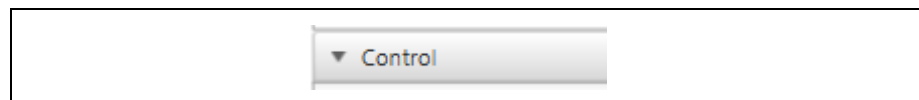

▼ Control

Description

Collapsible titled pane (Figure 12-37) containing push buttons used to perform LoRaWAN Control actions.

Execution conditions

- Left click on field

MAC Pause/Resume

FIGURE 12-38: MAC PAUSE/RESUME PUSH BUTTONS



Description

This push button is used to Pause the LoRaWAN within the RN Module which is sometimes required to perform specific actions ([Figure 12-38](#)). When the LoRaWAN has been paused this button will change to read "Resume", which allows the LoRaWAN to regain control of the RN Modules transceiver.

Execution conditions

- Left click on button

Module Commands

- `mac pause`
- `mac resume`

MAC Reset

FIGURE 12-39: MAC RESET PUSH BUTTON

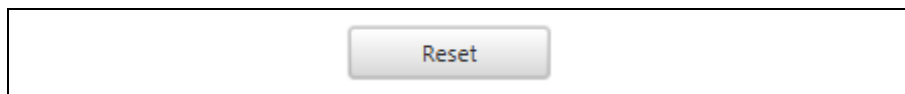

Description

This push button is used to issue a standard Reset request to the RN Module ([Figure 12-39](#)). This does a soft Reset on the part, but does not remove stored Key values for authentication.

Execution conditions

- Left click on button

Module Commands

- `mac reset`

MAC Force Enable

FIGURE 12-40: FORCE ENABLE MAC PUSH BUTTON

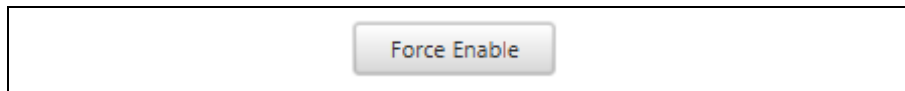

Description

This push button is used to force the RN Module to use the LoRaWAN even if it has been paused or suspended previously ([Figure 12-40](#)).

Execution conditions

- Left click on button

Module Commands

- `mac forceENABLE`

Emulated Serial Terminal Titled Pane

FIGURE 12-41: IN UTILITY SERIAL TERMINAL

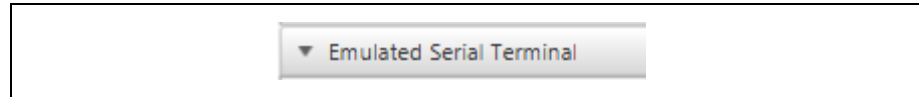

Description

Collapsible titled pane containing a Serial Terminal Emulator ([Figure 12-41](#)).

Execution conditions

- Left click on field

Raw Serial Command

FIGURE 12-42: RAW COMMAND TEXT FIELD

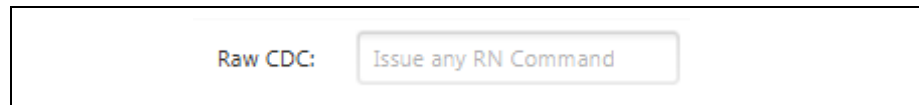

Description

The `<rawCDC>` text field ([Figure 12-42](#)) is used to directly write commands to the RN Module. Use of this text field is for those with advanced knowledge of the full RN Module command syntax.

Execution conditions

- Updates Model when **Enter** is pressed in Text Field
- Pressing the **Issue Command** push button

Issue Command

FIGURE 12-43: ISSUE RAW COMMAND PUSH BUTTON

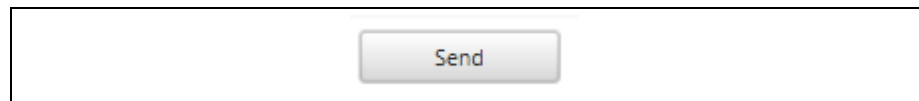

Description

This push button sends the string message currently stored in `<rawCDC>` text field and transmits it to the RN Module ([Figure 12-43](#)).

Execution conditions

- Left click on button

Module Commands

- `sys get ver`

Information Titled Pane

FIGURE 12-44: RN MODULE INFORMATION TITLED PANE

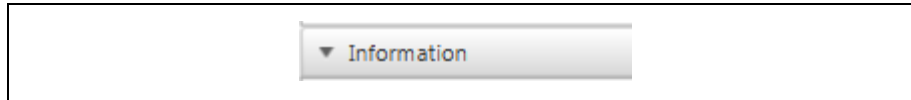

Description

Collapsible titled pane containing RN Module Build Information ([Figure 12-44](#)).

Execution conditions

- Left click on field

Module Version and Build Information

FIGURE 12-45: BUILD INFORMATION DISPLAY



Description

Label showing RN Module build information related to the programming of the device ([Figure 12-45](#)).

12.3.2 RN Module Channel Tab Descriptions

Below are the interactive elements of the **MAC Channels** tab inside the RN Module Device Model, as represented in [Figure 12-46](#):

1. Single Channel titled pane
2. Channel Number Selection
3. Channel Usage Indicator
4. Channel Status
5. Channel Frequency⁽¹⁾
6. Channel Minimum Data Rate
7. Channel Maximum Data Rate
8. Channel Duty Cycle⁽²⁾
9. Configure Channel
10. Multiple Channel titled pane
11. Disable All Channels
12. Enable first (eight) Channels
13. Enable All Channels

Note 1: Available only on RN2483

2: Read only on RN2903; Configurable on RN2483

FIGURE 12-46: RN MODULE MAC CHANNELS TAB LAYOUT (RN2483)

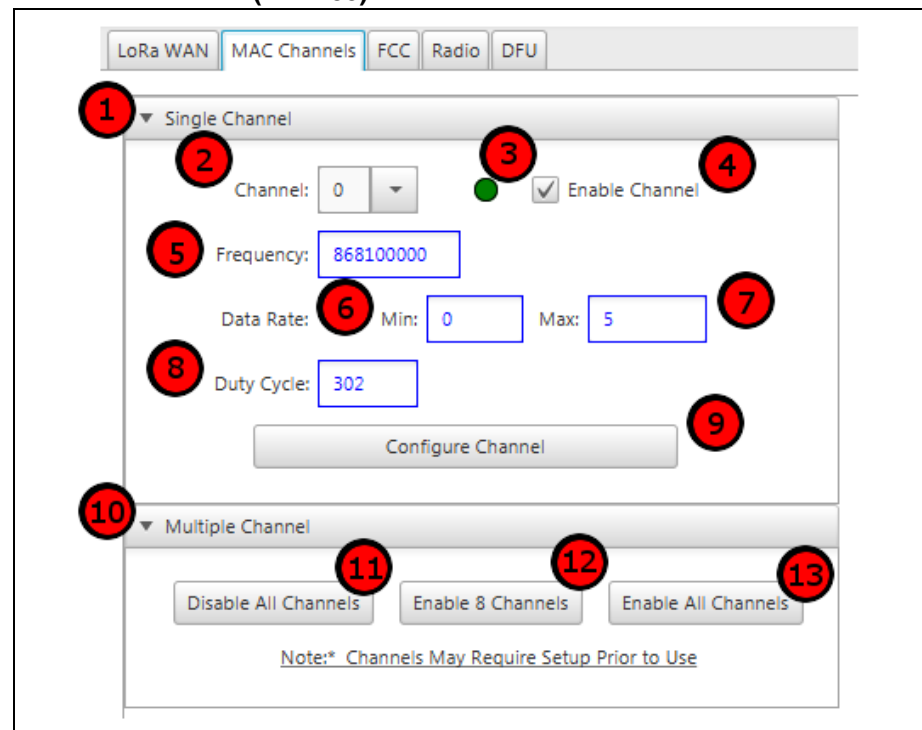
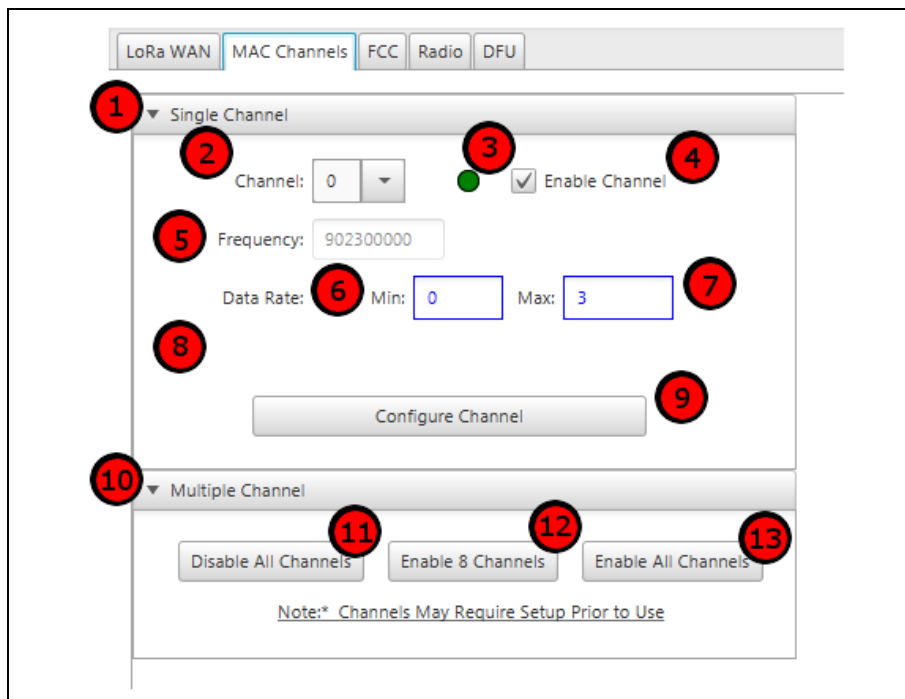
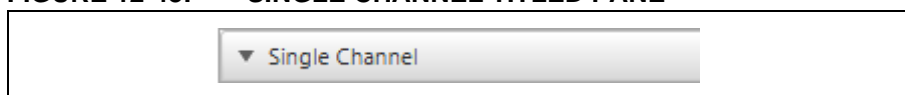

FIGURE 12-47: RN MODULE MAC CHANNELS TAB LAYOUT



Single Channel Titled Pane

FIGURE 12-48: SINGLE CHANNEL TITLED PANE



Description

Collapsible titled pane Single Channel Configuration Parameters (Figure 12-48).

Execution conditions

- Left click on field

Channel Number Selection

FIGURE 12-49: MAC CHANNEL COMBO BOX



Description

Combo box used to select the <channelNumber> (Figure 12-49) which is being configured using the Single Channel pane.

Combo Box options

- RN2483
 - 0 - 15
- RN2903
 - 0 - 63

Execution conditions

- Combo box selection

Module Commands

- `mac get ch status <channelNumber>`

Channel Usage Indicator

FIGURE 12-50: CHANNEL STATUS INDICATOR

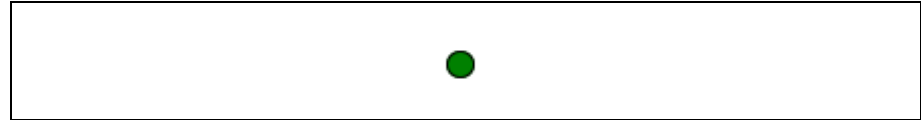

Description

Small color indicator showing if the currently selected channel is active or disabled (Figure 12-50).

Execution conditions

- Alters between Green/Red based upon Channel Status at combo box selection

Channel Status

FIGURE 12-51: CHANNEL STATUS CHECKBOX



Description

The `<channelStatus>` checkbox (Figure 12-51) is used to enable/disable the selected channel for use by the LoRaWAN. Only enabled channels are capable of being used by the LoRaWAN when issuing Uplink Messages.

Execution conditions

- Left click on box to alter `<channelStatus>` between On/Off.
- Press **Configure Channel** push button

Module Commands

- `mac set ch status <channelStatus>`

Channel Frequency

FIGURE 12-52: CHANNEL FREQUENCY TEXT FIELD



Description

The `<chFrequency>` text field (Figure 12-52) is used to show or configure the frequency used by the LoRaWAN when it transmits on the specified channel. Configuration of the channel frequency can only be done to the RN2483 module, and ONLY for channels 3-15. For the RN2903 module, all channel (0-63) frequencies are set by the LoRaWAN specification, and are read-only.

Execution conditions

- Issues command when **Enter** is pressed in text field
- Press **Configure Channel** push button

Module Commands

- `mac set ch freq 3 868500000`

Channel Minimum Data Range

FIGURE 12-53: MINIMUM DATA RATE TEXT FIELD

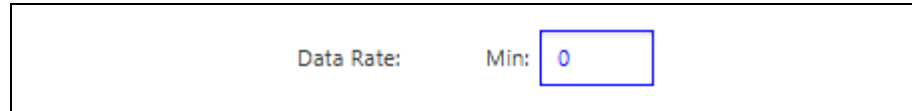

The screenshot shows a text input field with the label "Data Rate: Min:" and the value "0". The field is highlighted with a blue border.

Description

The `<minDataRate>` text field (Figure 12-53) is used to show or configure the minimal data rate used on the specified channel.

Execution conditions

- Issues command configuring both Min and Max Data Rate on **Enter** in field
- Press **Configure Channel** push button

Module Commands

- `mac set ch drrange 15 0 3`

Channel Maximum Data Range

FIGURE 12-54: MAXIMUM DATA RATE TEXT FIELD



The screenshot shows a text input field with the label "Data Rate: Max:" and the value "3". The field is highlighted with a blue border.

Description

The `<maxDataRate>` text field (Figure 12-54) is used to show or configure the maximum data rate used on the specified channel.

Execution conditions

- Issues command configuring both Min and Max Data Rate on **Enter** in field
- Press **Configure Channel** push button

Module Commands

- `mac set ch drrange 15 0 3`

Channel Duty Cycle

FIGURE 12-55: DUTY CYCLE TEXT FIELD



Description

The <chDutyCycle> text field (Figure 12-55) is used to show or configure the duty cycle setting for the currently selected channel. Duty Cycle is not configurable for the RN2903, and thus this field is hidden.

Execution conditions

- Updates Model when **Enter**
- Press **Configure Channel** push button

Module Commands

- `mac set ch dcycle 3 302`

Configure Channel

FIGURE 12-56: CONFIGURE CHANNEL PUSH BUTTON

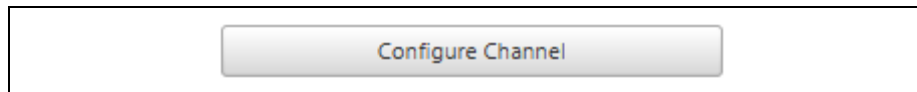

Description

This push button will configure the currently selected channel according to the parameter settings in **Single Channel** pane (Figure 12-56).

Execution conditions

- Left click on button

Module Commands

- `mac set ch freq 6 868000000`
- `mac set ch drrange 6 0 2`
- `mac set ch dcycle 6 579`
- `mac set ch status 6 on`

Multiple Channels Titled Pane

FIGURE 12-57: MULTIPLE CHANNELS TITLED PANE

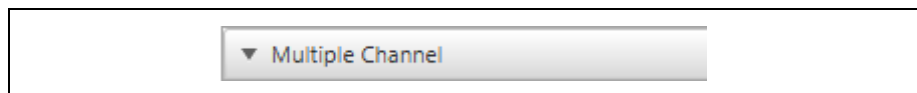

Description

Collapsible titled pane (Figure 12-57) with multi-channel command execution functions.

Execution conditions

- Left click on field

Disable All Channels

FIGURE 12-58: DISABLE ALL CHANNELS PUSH BUTTON

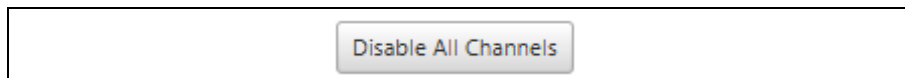

Description

This push button is used to disable all channels available on the RN Module ([Figure 12-58](#)).

Execution conditions

- Left click on field

Module Command

```
• mac set ch status 0 off
...
mac set ch status 63 off
```

Enable First 8 Channels

FIGURE 12-59: ENABLE 8 CHANNELS PUSH BUTTON

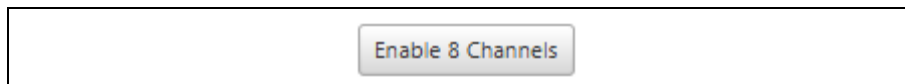

Description

This push button is used to enable only the first eight channels ([Figure 12-59](#)). The LoRa Microchip Gateway is only capable of communication on the first eight channels.

Execution conditions

- Left click on field

Module Command

```
• mac set ch status 0 on
...
mac set ch status 8 on
```

Enable All Channels

FIGURE 12-60: ENABLE ALL CHANNELS PUSH BUTTON

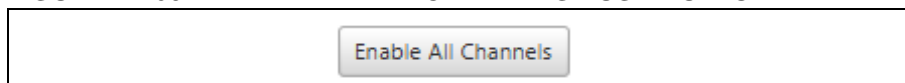

Description

This push button is used to enable all channels available on the RN Module ([Figure 12-60](#)).

Execution conditions

- Left click on field

Module Command

```
• mac set ch status 0 on
...
mac set ch status 63 on
```

12.3.3 RN Module FCC Tab Descriptions

Below are the interactive elements of the **FCC** tab inside the RN Module Device Model, as represented in [Figure 12-61](#):

1. Standard FCC titled pane
2. FCC test spreading factor
3. FCC test payload size
4. FCC Continuous Wave titled pane
5. Minimal Frequency Continuous Wave
6. Middle Frequency Continuous Wave
7. Maximum Frequency Continuous Wave
8. Narrow Band FCC Transmit Test titled pane
9. Narrow Minimal Frequency Transmit Test
10. Narrow Middle Frequency Transmit Test
11. Narrow Maximum Frequency Transmit Test
12. Narrow Band Hopping
13. Narrow Band Sweeping
14. Wide Band FCC Transmit Test titled pane
15. Wide Minimal Frequency Transmit Test
16. Wide Middle Frequency Transmit Test
17. Wide Maximum Frequency Transmit Test
18. Wide Band Hopping
19. Wide Band Sweeping
20. Custom FCC setup titled pane
21. Custom Spreading Factor
22. Custom Payload Size
23. Custom Frequency
24. Custom Bandwidth
25. Custom test method
26. Start Custom test
27. Stop Continuous Wave test
28. Stop Generic test
29. Stop Custom test

LoRa[®] Technology Evaluation Suite User's Guide

FIGURE 12-61: RN2483 MODULE FCC TESTING TAB LAYOUT

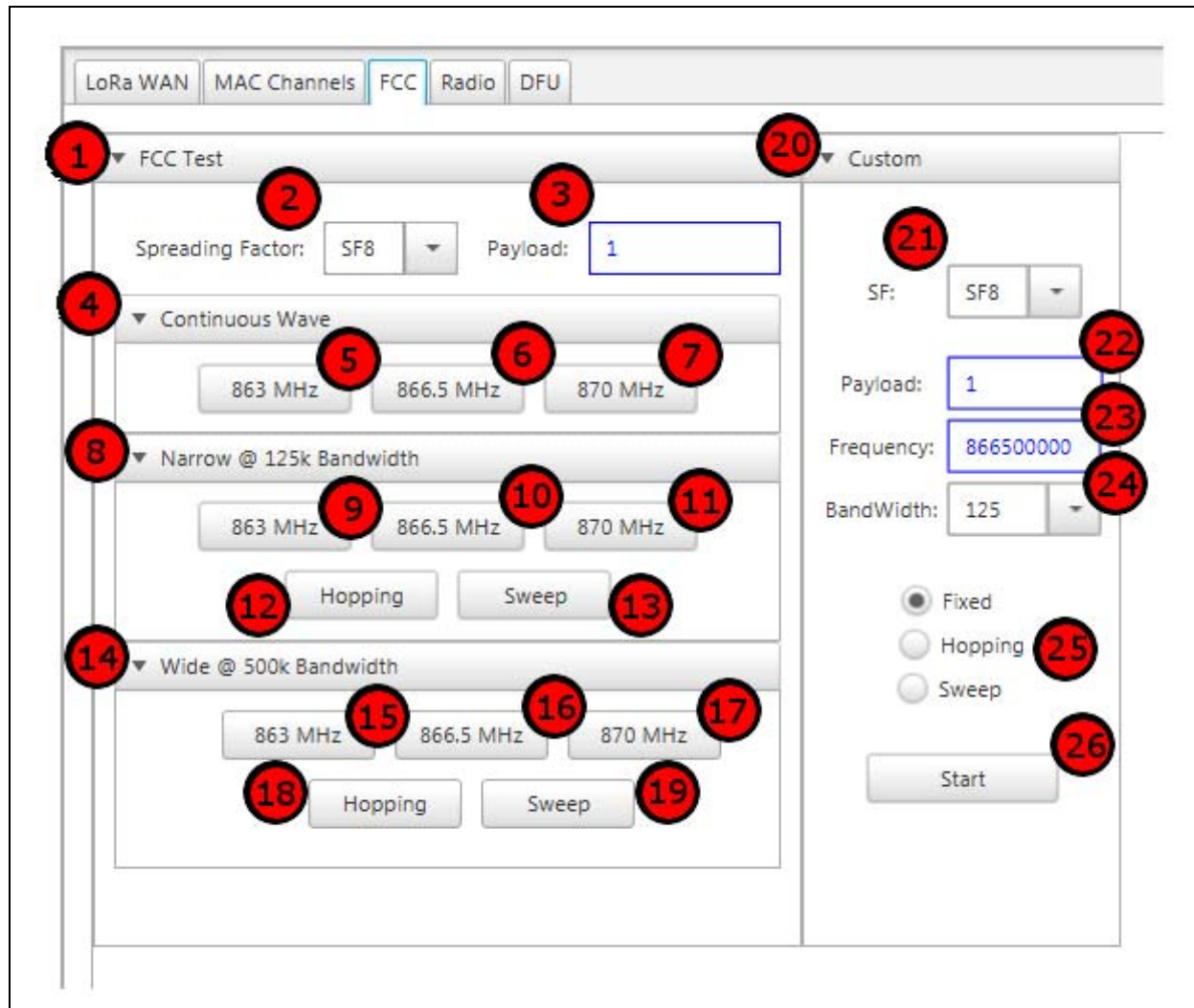

FIGURE 12-62: RN2903 MODULE FCC TESTING TAB LAYOUT

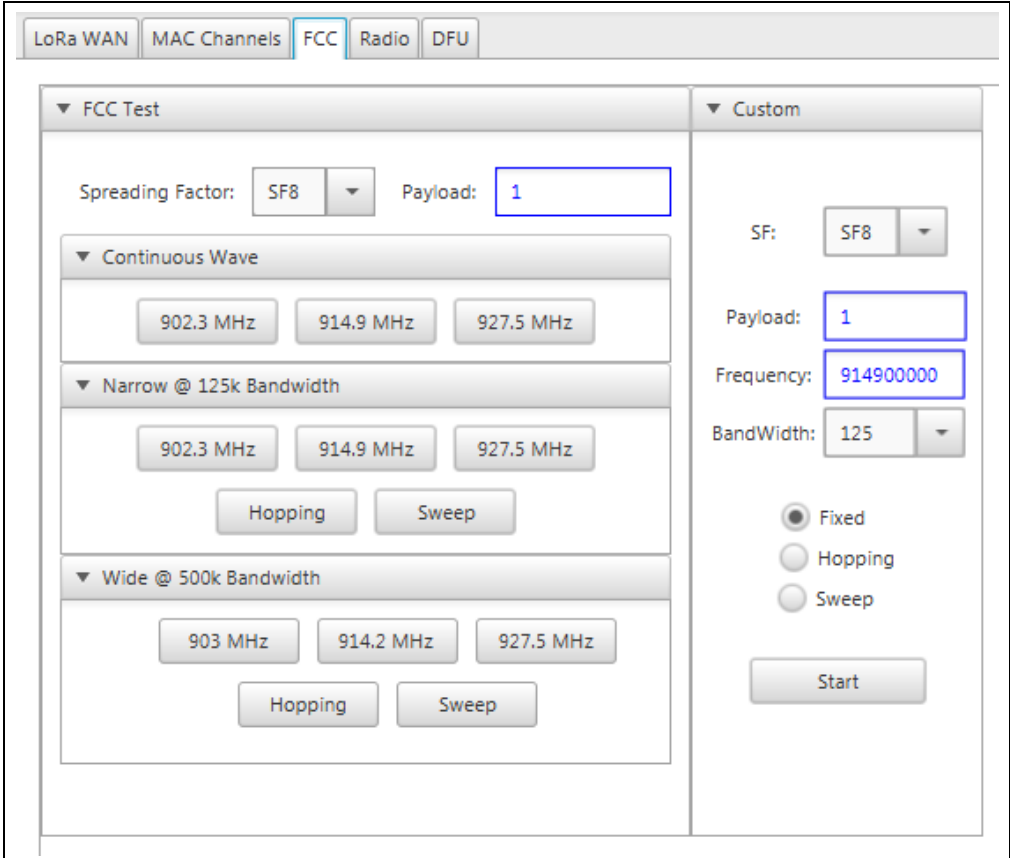

FIGURE 12-63: ACTIVE CONTINUOUS WAVE TEST

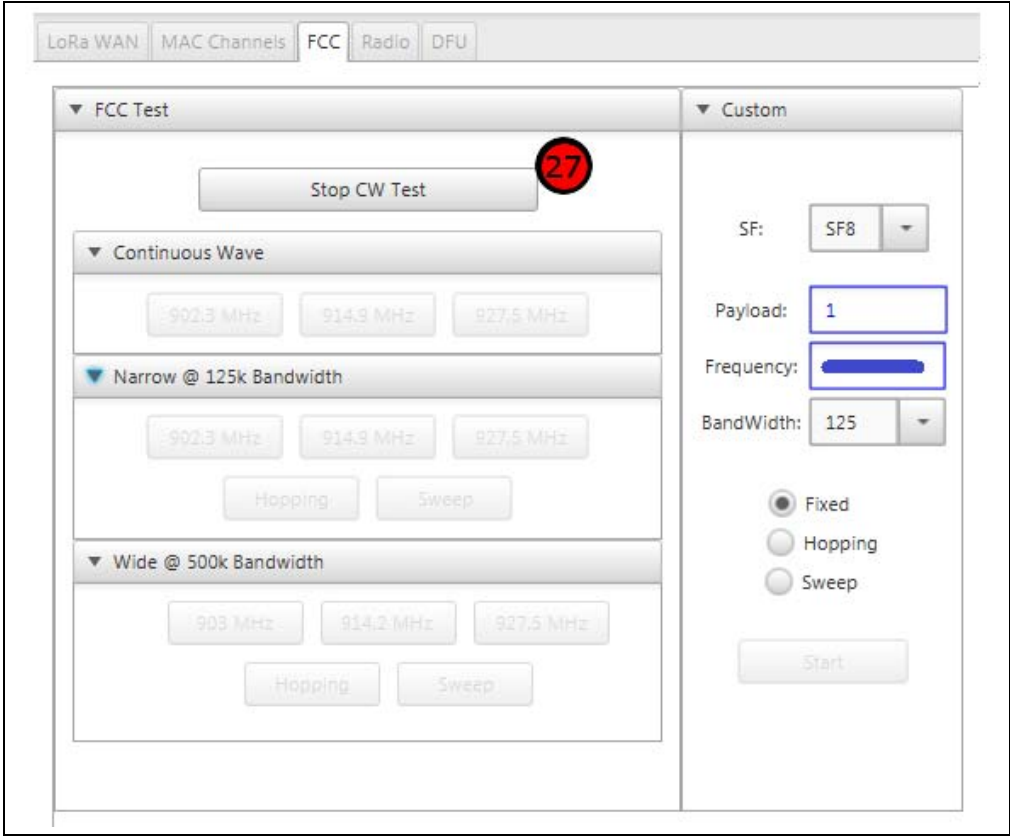

FIGURE 12-64: ACTIVE GENERIC TEST

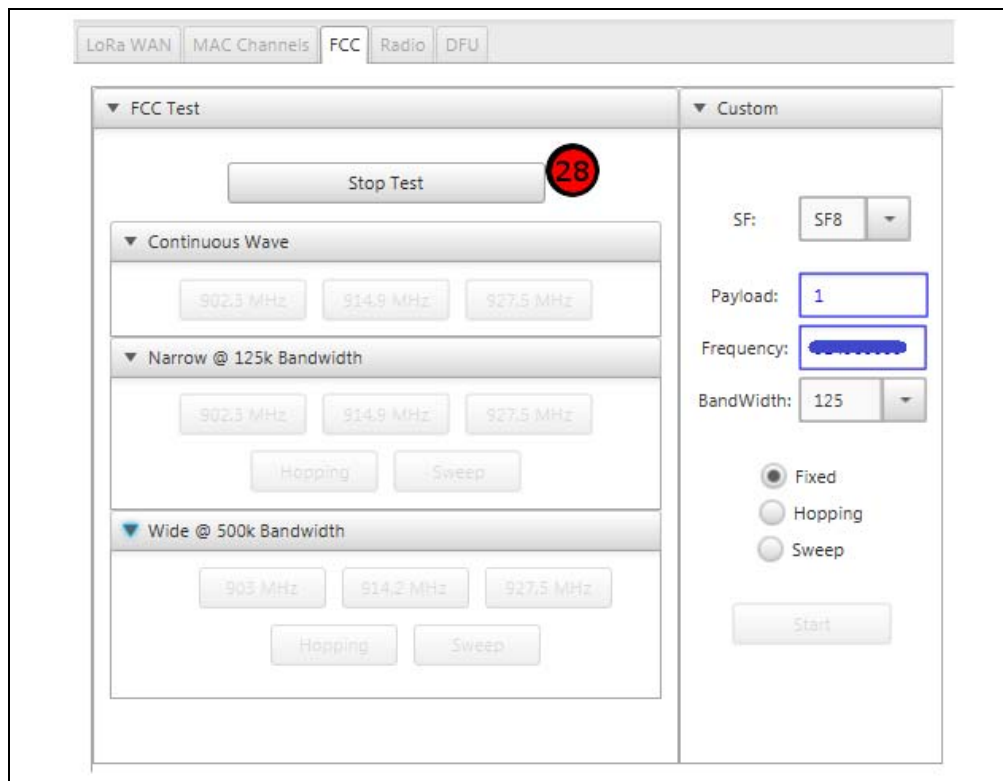
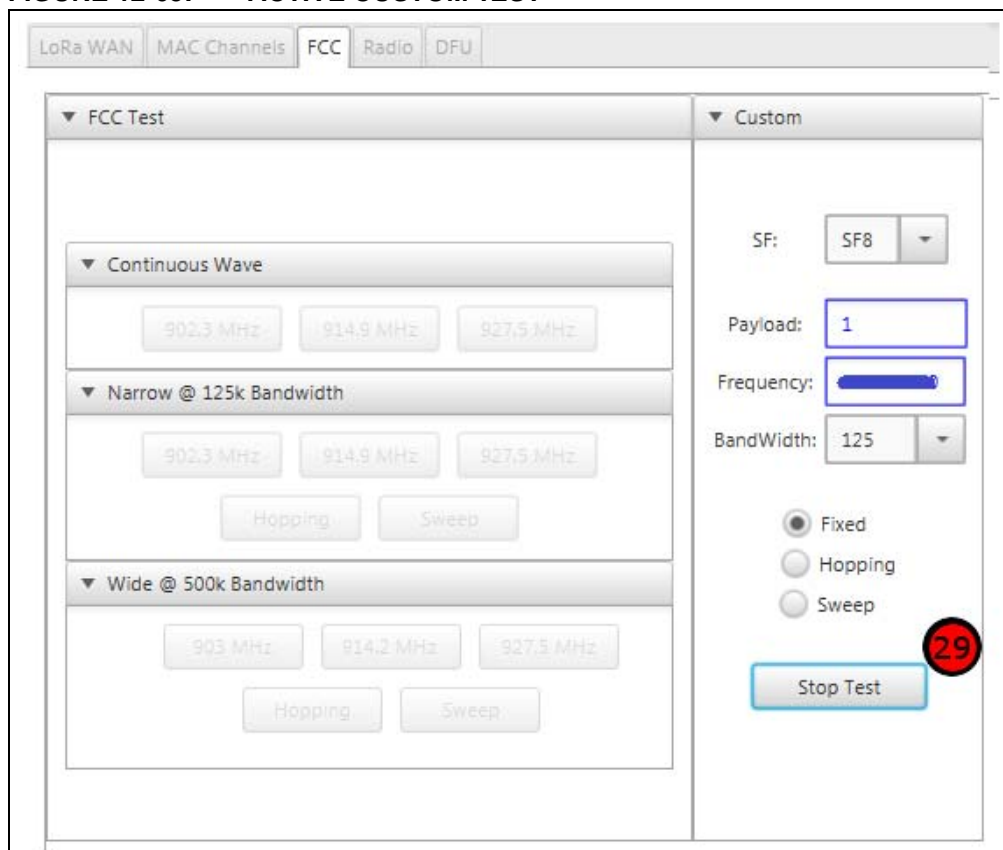

FIGURE 12-65: ACTIVE CUSTOM TEST



Standard FCC Titled Pane

FIGURE 12-66: FCC TEST TITLED PANE



Description

Collapsible titled pane (Figure 12-66) containing settings and macros used for Microchip's RN Module FCC certification.

It is important to note that when exercising the LoRa Transceiver outside of standard operations, the LoRaWAN must be paused.

Execution conditions

- Left click on field

FCC Test Spreading Factor

FIGURE 12-67: FCC TEST SPREADING FACTOR COMBO BOX



Description

This combo box affects all FCC test runs from within the FCC Test titled pane (Figure 12-67). Spreading Factor parameter value is applied to the RN Module prior to execution of the FCC test.

Combo Box options

- SF7, SF8, SF9, SF10, SF11, SF12

Execution conditions

- Execution of any of the available FCC Test

FCC Test Payload Size

FIGURE 12-68: FCC TEST PAYLOAD SIZE TEXT FIELD

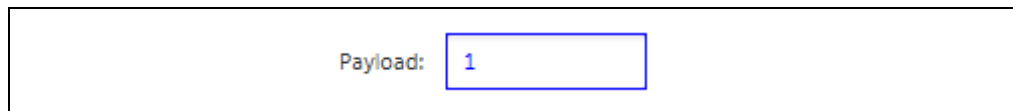

Description

This text field represents in bytes the size of the Payload when running one of the available FCC test options (Figure 12-68).

Data for the payload is constructed by sequentially appending bytes into a string. For example, a Payload of size 8 would be constructed as: 0102030405060708.

Execution conditions

- Execution of any of the available FCC Test

FCC Continuous Wave Titled Pane

FIGURE 12-69: CW TITLED PANE

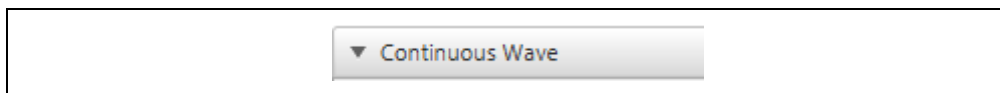

Description

Collapsible titled pane (Figure 12-69) containing standard Continuous Wave test frequency range options. Spreading Factor will be taken from the FCC Test area while remaining radio parameter settings currently stored by the RN Module will be used for this test. Current RN Module settings will be used, to better aid in tuning, debugging or testing designs.

Execution conditions

- Left click on field

Minimal Frequency Continuous Wave

FIGURE 12-70: MINIMAL FREQUENCY CW PUSH BUTTON

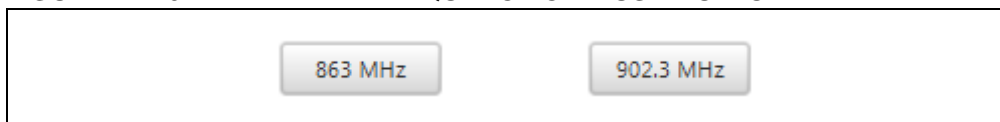

Description

This push button will exercise the Transceiver producing a Continuous Wave at the band Minimal frequency range (Figure 12-70).

Execution conditions

- Left click on field

Module Command

- radio set mod lora
- radio set pwr 1
- radio set bw 125
- radio set afcbw 41.7
- radio set rxbw 125
- radio set freq 863000000 -or- 902300000
- radio set fdev 25000
- radio set bitrate 50000
- radio set prlen 8
- radio set crc on
- radio set cr 4/5
- radio set bt 0.5
- radio set iq off
- radio set sf SF8
- radio set wdt 10000
- radio set cw on

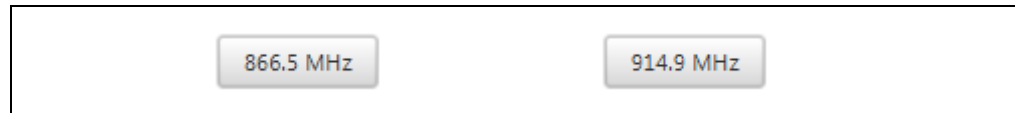
Middle Frequency Continuous Wave**FIGURE 12-71: MIDDLE FREQUENCY CW PUSH BUTTON****Description**

This push button will exercise the Transceiver producing a Continuous Wave at the band Middle frequency point ([Figure 12-71](#)).

Execution conditions

- Left click on field

Module Command

- radio set mod lora
- radio set pwr 1
- radio set bw 125
- radio set afcbw 41.7
- radio set rxbw 125
- radio set freq 866500000 -or- 914900000
- radio set fdev 25000
- radio set bitrate 50000
- radio set prlen 8
- radio set crc on
- radio set cr 4/5
- radio set bt 0.5
- radio set iq1 off
- radio set sf SF8
- radio set wdt 10000
- radio set cw on

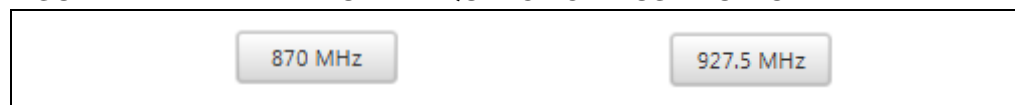
Maximum Frequency Continuous Wave**FIGURE 12-72: MAXIMUM FREQUENCY CW PUSH BUTTON****Description**

This push button will exercise the Transceiver producing a Continuous Wave at the band Maximum frequency point ([Figure 12-72](#)).

Execution conditions

- Left click on field

Module Command

- radio set mod lora
- radio set pwr 1
- radio set bw 125
- radio set afcbw 41.7
- radio set rxbw 125
- radio set freq 870000000 -or- 927500000

- radio set fdev 25000
- radio set bitrate 50000
- radio set prlen 8
- radio set crc on
- radio set cr 4/5
- radio set bt 0.5
- radio set iqi off
- radio set sf SF8
- radio set wdt 10000
- radio set cw on

Narrow Band FCC Continuous Wave Titled Pane

FIGURE 12-73: NARROW FREQUENCY TEST TITLED PANE

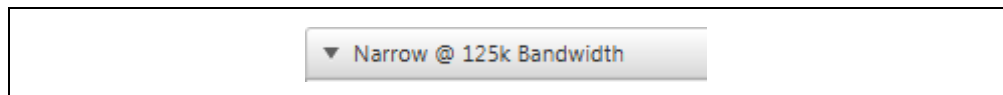

Description

Collapsible titled pane containing Narrow Bandwidth Transmission Test ([Figure 12-73](#)). Narrow Bandwidth is defined as the LoRa Bandwidth set to 125 kHz. Spreading Factor and Payload Size will be taken from the FCC Test area, while remaining radio parameter settings currently stored by the RN Module will be used for this test.

The Narrow FCC test is executed by configuring the Radio, issuing a `PAUSE` action to the LoRaWAN prior to executing a transmission. The transceiver will transmit a dummy data Payload with the size specified by the field. Once the transmission action is completed the RN Module will return "radio_tx_ok". The LoRaWAN is re-enabled by issuing a `mac resume` command, after which the test will repeat. The testing cycle will continue until **Stop Test** push button is pressed.

Execution conditions

- Left click on field

Narrow Minimal Frequency Transmit Test

FIGURE 12-74: MINIMAL FREQUENCY NARROW PUSH BUTTON



Description

This push button exercises the transceiver to issue a transmission at the bands Minimal Frequency while setting the LoRa bandwidth to 125 kHz ([Figure 12-74](#)).

Execution conditions

- Left click on field

Module Command

- radio set mod lora
- radio set pwr 1
- radio set bw 125
- radio set afcbw 41.7
- radio set rxbw 125

- radio set freq 863000000 -or- 902300000
- radio set fdev 25000
- radio set bitrate 50000
- radio set prlen 8
- radio set crc on
- radio set cr 4/5
- radio set bt 0.5
- radio set iqf off
- radio set sf SF8
- radio set wdt 10000
- mac pause
- radio tx
- 0102030405060708090A0B0C0D0E0F101112131415 (Payload:21)
- mac resume

Narrow Middle Frequency Transmit Test

FIGURE 12-75: MIDDLE FREQUENCY NARROW PUSH BUTTON



Description

This push button exercises the transceiver to issue a transmission at the bands Middle Frequency while setting the LoRa bandwidth to 125 kHz ([Figure 12-75](#)).

Execution conditions

- Left click on field

Module Command

- radio set mod lora
- radio set pwr 1
- radio set bw 125
- radio set afcbw 41.7
- radio set rxbw 125
- radio set freq 866500000 -or- 914900000
- radio set fdev 25000
- radio set bitrate 50000
- radio set prlen 8
- radio set crc on
- radio set cr 4/5
- radio set bt 0.5
- radio set iqf off
- radio set sf SF8
- radio set wdt 10000
- mac pause
- radio tx 0102030405060708090A0B0C0D0E0F (Payload:15)
- mac resume

Narrow Maximum Frequency Transmit Test

FIGURE 12-76: MAXIMUM FREQUENCY NARROW PUSH BUTTON



Description

This push button exercises the transceiver to issue a transmission at the bands Maximum Frequency while setting the LoRa bandwidth to 125 kHz (Figure 12-76).

Execution conditions

- Left click on field

Module Command

- radio set mod lora
- radio set pwr 1
- radio set bw 125
- radio set afcbw 41.7
- radio set rxbw 125
- radio set freq 870000000 -or- 927500000
- radio set fdev 25000
- radio set bitrate 50000
- radio set prlen 8
- radio set crc on
- radio set cr 4/5
- radio set bt 0.5
- radio set iq1 off
- radio set sf SF8
- radio set wdt 10000
- mac pause
- radio tx 01 (Payload:1)
- mac resume

Narrow Band Hopping

FIGURE 12-77: NARROW HOPPING TEST PUSH BUTTON

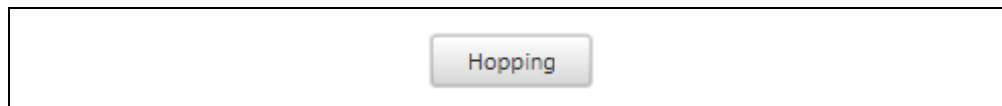

Description

This push button exercises the transceiver to issue a transmissions Hopping with each successful transmission to another frequency within its range (Figure 12-77). This is performed with a LoRa bandwidth of 125 kHz.

Hopping test is performed by first transmitting at the Middle frequency, then after completion changing the frequency to the lowest possible in the band. Once a transmission is sent, the device will again transmit at the Middle frequency, before incrementing the lowest frequency by 1 MHz. It will repeat this cycle until the 1 MHz additions reaches the Highest allowed frequency, after which it will repeat the entire cycle.

Exercised Frequency Range

TABLE 12-2: NARROW FCC HOPPING TEST

Module	RN2483	RN2903
Frequency Range	863 - 870 MHz	902 - 927 MHz
Hops	7	25

Execution conditions

- Left click on field

Module Command

- radio set mod lora
- radio set pwr 1
- radio set bw 125
- radio set afcbw 41.7
- radio set rxbw 125
- radio set freq 866500000 -or- 914900000
- radio set fdev 25000
- radio set bitrate 50000
- radio set prlen 8
- radio set crc on
- radio set cr 4/5
- radio set bt 0.5
- radio set iqf off
- radio set sf SF8
- radio set wdt 10000
- mac pause
- radio tx 01 (Payload:1)
- mac resume
- radio set frequency 863000000 -or- 902000000
- mac pause
- radio tx 01
- mac resume
- radio set frequency 866500000 -or- 914900000
- mac pause
- radio tx 01 (Payload:1)
- mac resume
- radio set frequency 864000000 -or- 903000000
- mac pause
- etc.....

Narrow Band Sweeping

FIGURE 12-78: NARROW SWEEPING TEST PUSH BUTTON

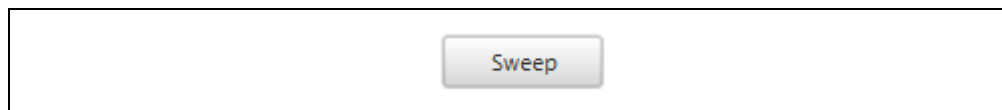

Description

This push button exercises the transceiver to issue a transmissions Sweep through the entire available band, issuing a transmission at each frequency (Figure 12-78). This is performed with a LoRa bandwidth of 125 kHz.

Sweeping test is performed by first transmitting at the Middle frequency, then after completion changing the frequency to the lowest possible in the band. Once a transmission is sent, the frequency will be increased by 200 kHz and another transmission will occur. The test will exhaust the full range before returning to the center frequency, then cycling the test.

Exercised Frequency Range

TABLE 12-3: NARROW FCC SWEEPING TEST

Module	RN2483	RN2903
Frequency Range	863 - 870 MHz	902 - 927 MHz
Sweeps	35	125

Execution conditions

- Left click on field

Module Command

- radio set mod lora
- radio set pwr 1
- radio set bw 125
- radio set afcbw 41.7
- radio set rxbw 125
- radio set freq 866500000 -or- 914900000
- radio set fdev 25000
- radio set bitrate 50000
- radio set prlen 8
- radio set crc on
- radio set cr 4/5
- radio set bt 0.5
- radio set iqf off
- radio set sf SF8
- radio set wdt 10000
- mac pause
- radio tx 01 (Payload:1)
- mac resume
- radio set frequency 863000000 -or- 902000000
- mac pause
- radio tx 01
- mac resume
- radio set frequency 863200000 -or- 902200000
- mac pause

- radio tx 01 (Payload:1)
- mac resume
- radio set frequency 863400000 -or- 902400000
- mac pause
- etc.....

Wide Band FCC Continuous Wave Titled Pane

FIGURE 12-79: WIDE FREQUENCY TEST TITLED PANE

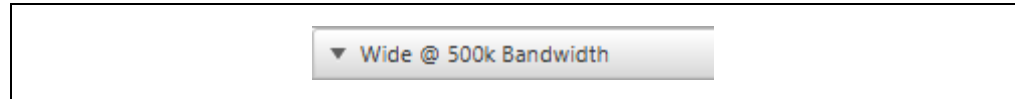

Description

Collapsible titled pane containing Wide Bandwidth Transmission Test (Figure 12-79). Wide Bandwidth is defined as the LoRa bandwidth set to 500 kHz. Spreading Factor and Payload Size will be taken from the FCC Test area, while remaining radio parameter settings currently stored by the RN Module will be used for this test.

The Wide FCC test is executed by configuring the Radio, issuing a **Pause** action to the LoRaWAN prior to executing a transmission. The transceiver will transmit a dummy data Payload with the size specified by the field. Once the transmission action is completed the RN Module will return "radio_tx_ok". The LoRaWAN is re-enabled by issuing a `mac resume` command, after which the test will repeat. The testing cycle will continue until **Stop Test** push button is pressed.

Execution conditions

- Left click on field

Wide Minimal Frequency Transmit Test

FIGURE 12-80: MINIMAL FREQUENCY WIDE TEST PUSH BUTTON



Description

This push button exercises the transceiver to issue a transmission at the bands Minimal Frequency while setting the LoRa bandwidth to 500 kHz (Figure 12-80).

Execution conditions

- Left click on field

Module Command

- radio set mod lora
- radio set pwr 1
- radio set bw 500
- radio set afcbw 41.7
- radio set rxbw 125
- radio set freq 863000000 -or- 902300000
- radio set fdev 25000
- radio set bitrate 50000
- radio set prlen 8
- radio set crc on

- radio set cr 4/5
- radio set bt 0.5
- radio set iqf off
- radio set sf SF8
- radio set wdt 10000
- mac pause
- radio tx 010203 (Payload:3)
- mac resume

Wide Middle Frequency Transmit Test

FIGURE 12-81: MIDDLE FREQUENCY WIDE TEST PUSH BUTTON



Description

This push button exercises the transceiver to issue a transmission at the bands Middle Frequency while setting the LoRa bandwidth to 500 kHz (Figure 12-81).

Execution conditions

- Left click on field

Module Command

- radio set mod lora
- radio set pwr 1
- radio set bw 500
- radio set afcbw 41.7
- radio set rxbw 125
- radio set freq 866500000 -or- 914900000
- radio set fdev 25000
- radio set bitrate 50000
- radio set prlen 8
- radio set crc on
- radio set cr 4/5
- radio set bt 0.5
- radio set iqf off
- radio set sf SF8
- radio set wdt 10000
- mac pause
- radio tx 0102030405 (Payload:5)
- mac resume

Wide Maximum Frequency Transmit Test

FIGURE 12-82: MAXIMUM FREQUENCY WIDE TEST PUSH BUTTON



Description

This push button exercises the transceiver to issue a transmission at the bands Maximum Frequency while setting the LoRa bandwidth to 500 kHz (Figure 12-82).

Execution conditions

- Left click on field

Module Command

```

• radio set mod lora
• radio set pwr 1
• radio set bw 500
• radio set afcbw 41.7
• radio set rxbw 125
• radio set freq 870000000 -or- 927500000
• radio set fdev 25000
• radio set bitrate 50000
• radio set prlen 8
• radio set crc on
• radio set cr 4/5
• radio set bt 0.5
• radio set iq1 off
• radio set sf SF8
• radio set wdt 10000
• mac pause
• radio tx 0102030405060708090A (Payload:10)
• mac resume

```

Wide Band Hopping

FIGURE 12-83: WIDE HOPPING TEST PUSH BUTTON

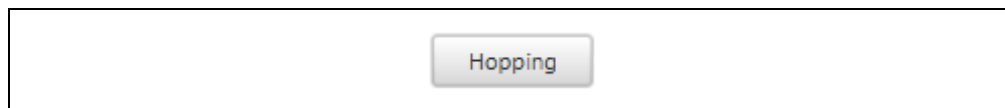

Description

This push button exercises the transceiver to issue a transmissions Hopping with each successful transmission to another frequency within its range (Figure 12-83). This is performed with a LoRa bandwidth of 500 kHz.

Hopping test is performed by first transmitting at the Middle frequency, then after completion, changing the frequency to the lowest possible in the band. Once a transmission is sent, the device will again transmit at the Middle frequency, before incrementing the lowest frequency by 1 MHz. It will repeat this cycle until the 1 MHz additions reaches the Highest allowed frequency, after which it will repeat the entire cycle.

Exercised Frequency Range

TABLE 12-4: WIDE HOPPING TEST

Module	RN2483	RN2903
Frequency Range	863 - 870 MHz	902 - 927 MHz
Hops	7	25

Execution conditions

- Left click on field

Module Command

- radio set mod lora
- radio set pwr 1
- radio set bw 500
- radio set afcbw 41.7
- radio set rxbw 125
- radio set freq 866500000 -or- 914900000
- radio set fdev 25000
- radio set bitrate 50000
- radio set prlen 8
- radio set crc on
- radio set cr 4/5
- radio set bt 0.5
- radio set iqi off
- radio set sf SF8
- radio set wdt 10000
- mac pause
- radio tx 01 (Payload:1)
- mac resume
- radio set frequency 863000000 -or- 902000000
- mac pause
- radio tx 01
- mac resume
- radio set frequency 866500000 -or- 914900000
- mac pause
- radio tx 01 (Payload:1)
- mac resume
- radio set frequency 864000000 -or- 903000000
- mac pause
- etc.....

Wide Band Sweeping

FIGURE 12-84: WIDE SWEEPING TEST PUSH BUTTON

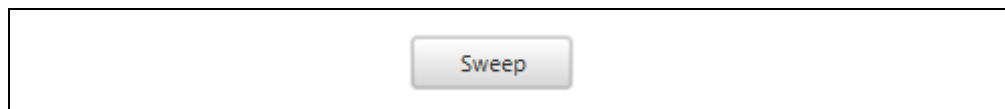

Description

This push button exercises the transceiver to issue a transmissions Sweep through the entire available band, issuing a transmission at each frequency (Figure 12-84). This is performed with a LoRa bandwidth of 500 kHz.

Sweeping test is performed by first transmitting at the Middle frequency, then after completion changing the frequency to the lowest possible in the band. Once a transmission is sent, the frequency will be increased by 200 kHz and another transmission will occur. The test will exhaust the full range before returning to the center frequency, then cycling the test.

Exercised Frequency Range

TABLE 12-5: WIDE SWEEPING TEST

Module	RN2483	RN2903
Frequency Range	863 - 870 MHz	902 - 927 MHz
Sweeps	35	125

Execution conditions

- Left click on field

Module Command

```

• radio set mod lora
• radio set pwr 1
• radio set bw 500
• radio set afcbw 41.7
• radio set rxbw 125
• radio set freq 866500000 -or- 914900000
• radio set fdev 25000
• radio set bitrate 50000
• radio set prlen 8
• radio set crc on
• radio set cr 4/5
• radio set bt 0.5
• radio set iqf off
• radio set sf SF8
• radio set wdt 10000
• mac pause
• radio tx 01
• mac resume
• radio set frequency 863000000 -or- 902000000
• mac pause
• radio tx 01
• mac resume
• radio set frequency 863200000 -or- 902200000
• mac pause
    
```

(Payload:1)

- radio tx 01 (Payload:1)
- mac resume
- radio set frequency 863400000 -or- 902400000
- mac pause
- etc.....

Custom FCC Setup Titled Pane

FIGURE 12-85: FCC CUSTOM TEST TITLED PANE

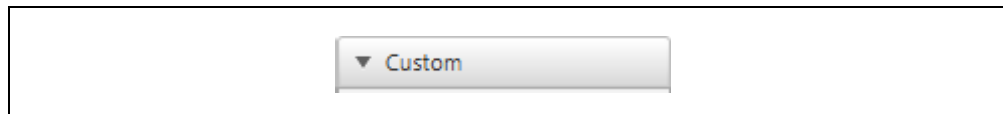

Description

Collapsible titled pane (Figure 12-85) containing settings and testing method used when executing a Custom FCC Test.

It is important to note that when exercising the LoRa Transceiver outside of standard operations, the LoRaWAN must be paused.

Execution conditions

- Left click on field

Custom Spreading Factor

FIGURE 12-86: CUSTOM TEST SPREADING FACTOR COMBO BOX



Description

This combo box <CustomSF> affects all FCC Custom Test (Figure 12-86). Spreading Factor parameter value is applied to the RN Module prior to execution of the FCC Custom Test.

Combo Box options

- SF7, SF8, SF9, SF10, SF11, SF12

Execution conditions

- Execution of any of the available FCC Custom Test

Custom Payload Size

FIGURE 12-87: CUSTOM FCC PAYLOAD SIZE TEXT FIELD

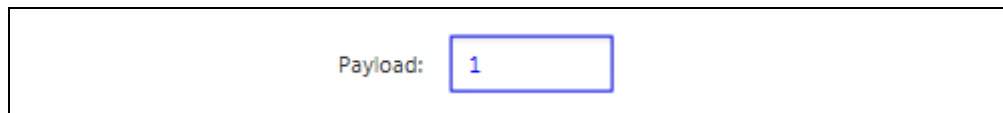

Description

This text field <CustomPayload> represents in bytes the size of the Payload when attempting to execute a Custom FCC Test (Figure 12-87).

Data for the payload is constructed by sequentially appending bytes into a string. For example, a Payload of size 8 would be constructed as: 0102030405060708.

Execution conditions

- Execution of any of the available FCC Custom Test

Custom Frequency

FIGURE 12-88: CUSTOM FCC TEST FREQUENCY TEXT FIELD



Description

This text field `<CustomCenterFrequency>` allows the user to modify what is considered the Center Frequency when running the Custom FCC Test (Figure 12-88).

Execution conditions

- Execution of any of the available FCC Custom Test

Custom Bandwidth

FIGURE 12-89: CUSTOM FCC TEST BANDWIDTH COMBO BOX



Description

This combo box `<CustomBandwidth>` allows the user to select the LoRa bandwidth used when running the Custom FCC Test (Figure 12-89).

Combo Box options

- 125, 250, 500 (kHz)

Execution conditions

- Execution of any of the available FCC Custom Test

Custom Test Method

FIGURE 12-90: CUSTOM FCC TRANSMISSION TEST RADIO BUTTON

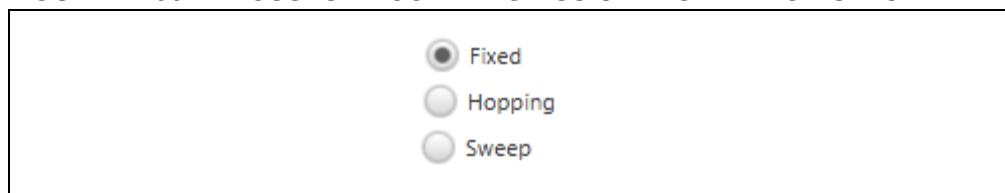

Description

This radio button `<CustomTestMethod>` group allows the user to select the type of test they wish to run using the FCC Custom Test parameter settings (Figure 12-90). Fixed only transmits at the specified Center Frequency, while Hopping and Sweeping work in the same way as describe previously.

Execution conditions

- Execution test type used by the FCC Custom Test

Start Custom Test

FIGURE 12-91: START CUSTOM FCC TEST PUSH BUTTON

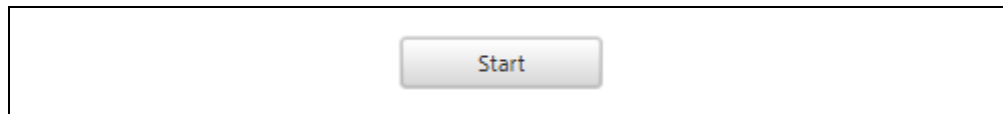

Description

This push button is used to start the Custom FCC Test (Figure 12-91).

Execution conditions

- On press

Module Command

See previous Module Command examples. Only the below may be changed.

- radio set sf <CustomSF>
- radio set bw <CustomBandwidth>
- radio set freq <CustomCenterFrequency>
- mac pause
- radio tx <CustomPayload>
- mac resume

Note: Cycle depends upon <CustomTestMethod> selected

Stop FCC CW Test

FIGURE 12-92: STOP CW TEXT PUSH BUTTON



Description

This push button will become visible and usable only when a FCC Continuous Wave test is being performed (Figure 12-92). Issuing a CW STOP command will automatically perform a SOFT RESET on the RN Module.

Execution conditions

- Execution of any of the available FCC Test

Module Command

- radio cw off

Stop FCC Test

FIGURE 12-93: FCC TEST PUSH BUTTON

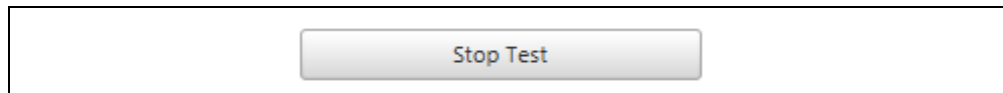

Description

This push button will become visible and usable only when a FCC Test is being performed (Figure 12-93). Pressing the **Stop** button will allow the current test to finish execution, and then stop the testing cycle.

Execution conditions

Execution of any of the available FCC Test

Stop Custom Test

FIGURE 12-94: STOP CUSTOM FCC TEST PUSH BUTTON

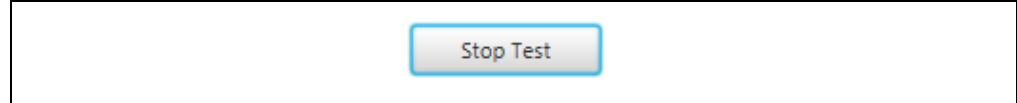

Description

This push button becomes/replaces the **Start Custom FCC Test** push button when a Custom Test is active/running. This push button is used to stop the Custom FCC Test (Figure 12-94). This push button will be replaced by the **Start** push button when the Custom FCC Test is deactivated.

Execution Condition

- On Press

Module Command

- None

Utility Action

- Disables Flag used to run Custom Test

12.3.4 RN Module Radio Tab Descriptions

Below are the interactive elements of the **Radio** tab inside the RN Module Device Model, as represented in [Figure 12-95](#):

1. Module Features titled pane
2. Radio Parameter titled pane
3. Output Transmit Power
4. Gauss Baseband Data Shaping
5. LoRa Bandwidth
6. Cylindrical Redundancy Check Enable
7. Receive Bandwidth
8. Error Coding
9. Automatic Frequency Correction Bandwidth
10. Modulation Mode
11. Frequency
12. Invert IQ Enable
13. Frequency Deviation
14. Watchdog Timer
15. Frequency Shift Keying Bit Rate
16. Spreading Factor
17. Preamble Length
18. Radio Sync Word
19. Module Voltage
20. Serial Noise Radio (SNR)
21. GPIO Control titled pane
22. GPIO Pin
23. GPIO Mode
24. Set/Refresh GPIO value
25. GPIO value field
26. Sleep titled pane
27. Sleep
28. Sleep length field
29. Nonvolatile Memory titled pane
30. Address field
31. Data field
32. Get/Set Nonvolatile Memory
33. General titled pane
34. Set Values
35. Get Values
36. Transceiver Communication titled pane
37. Transmit titled pane
38. Issue Transmission
39. Data Payload
40. Transmission Attempts
41. Receive titled pane
42. Receive Window length
43. Infinite Receive Window
44. Listen to Receive

FIGURE 12-95: RN MODULE RADIO TAB LAYOUT

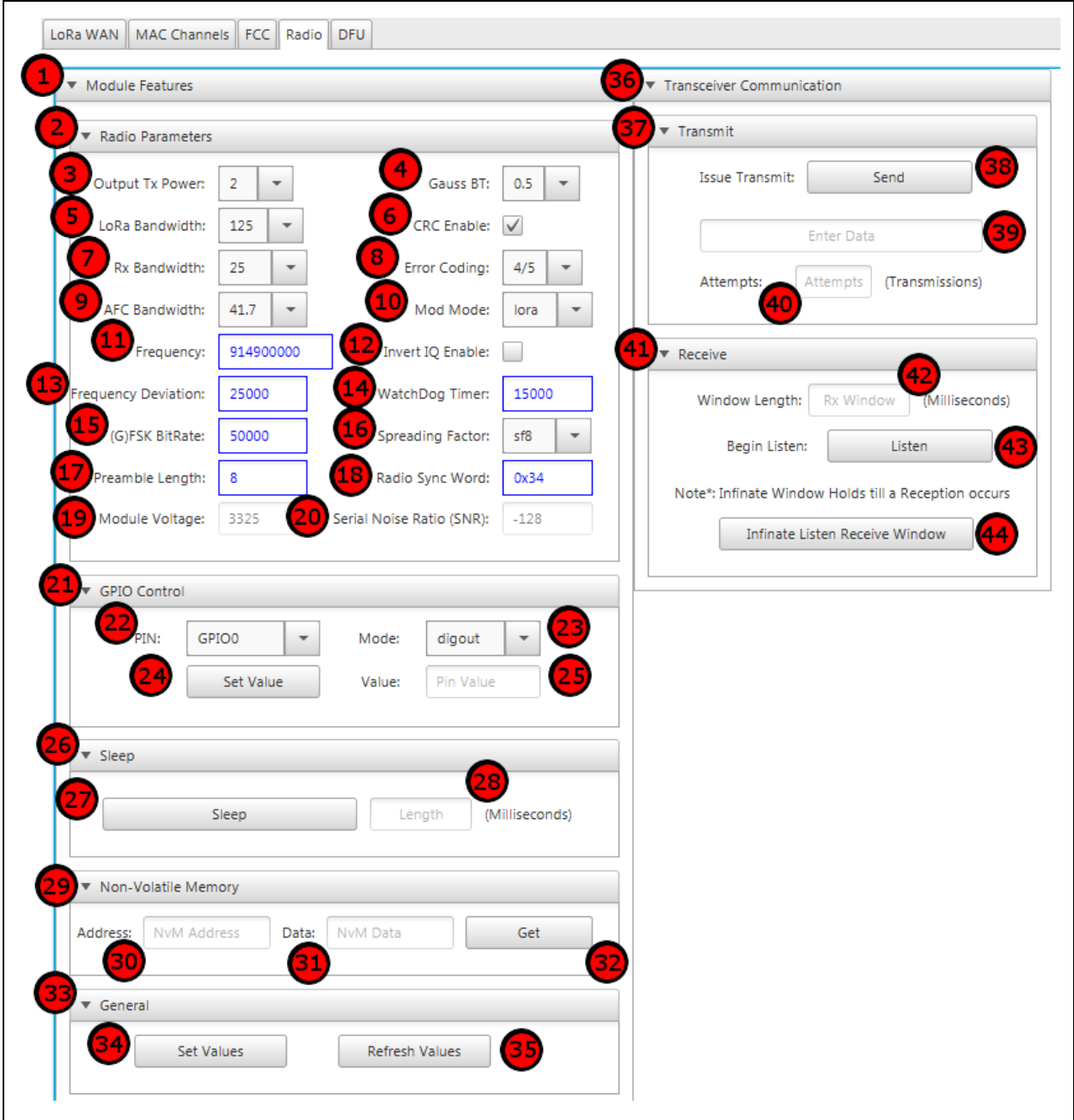

Module Features Titled Pane

FIGURE 12-96: RN MODULE FEATURES TITLED PANE

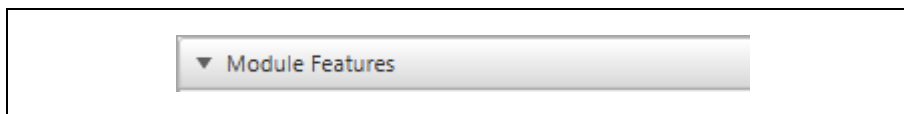

Description

Collapsible titled pane (Figure 12-96) containing a wide selection of configurable RN Module Radio settings. This pane can be used to exercise the all supported Radio Commands, and can be used for RN Module GPIO, Sleep and nonvolatile memory behavior interaction.

All currently stored parameter value settings are automatically loaded and reflected in the appropriate fields upon **Radio** tab selection.

Execution conditions

- Left click on field

Radio Parameter Titled Pane

FIGURE 12-97: RADIO PARAMETERS TITLED PANE



Description

Collapsible titled pane containing organizing configurable Radio parameters in clearly displayed layout (Figure 12-97).

Execution conditions

- Left click on field

Output Transmit Power

FIGURE 12-98: OUTPUT TRANSMISSION POWER COMBO BOX



Description

This combo box is used to configure the Output Transmit Power setting for the transceiver located inside the RN Module (Figure 12-98).

Combo Box options

- RN2483
 - -3, -2, -1, 0, 1, 2, 3, 4, 5, 6, 7, 8, 9, 10, 11, 12, 13, 14, 15
- RN2903
 - 2, 3, 4, 5, 6, 7, 8, 9, 10, 11, 12, 13, 14, 15, 16, 17, 18, 19, 20

Execution conditions

- Command execution occurs on combo box selection
- Push button **Set Values** is pressed

Module Command

- `radio set pwr 3`

Gauss Baseband Data Shaping**FIGURE 12-99: GAUSSIAN BASEBAND COMBO BOX****Description**

This combo box is used to configure the Gaussian baseband Data Shaping that is applied to signal modulation transmissions when (G)FSK mode is selected (Figure 12-99).

Combo Box options

- none, 1.0, 0.5, 0.3

Execution conditions

- Command execution occurs on combo box selection
- Push button **Set Values** is pressed

Module Command

- `radio set bt 0.5` push button

LoRa® Bandwidth**FIGURE 12-100: LoRa® BANDWIDTH COMBO BOX****Description**

This combo box is used to configure the Bandwidth applied to LoRa operations, in kHz (Figure 12-100).

Combo Box options

- 125, 250, 500

Execution conditions

- Command execution occurs on combo box selection
- Push button **Set Values** is pressed

Module Command

- `radio set bw 500`

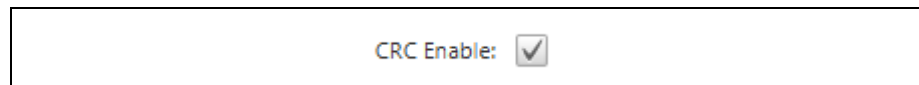
Cylindrical Redundancy Check Enable**FIGURE 12-101: CRC HEADER ENABLE CHECKBOX****Description**

The checkbox is used to enable/disable the use of CRC checks being included in the header when a transmission is attempted by the RN Module (Figure 12-101).

Execution conditions

- Left click on box to alter CRC header usage On/Off.
- Push button **Set Values** is pressed

Module Commands

- `radio set crc on`

Receive Bandwidth

FIGURE 12-102: Rx BANDWIDTH COMBO BOX

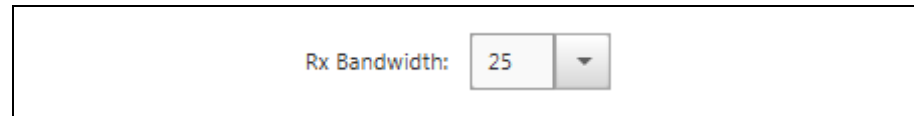

Description

This combo box is used to configure the Bandwidth applied to LoRa operations, in kHz ([Figure 12-102](#)).

Combo Box options

- 250, 200, 166.7, 125, 100, 83.3, 62.5, 50, 41.7, 31.3, 25, 20.8, 15.6, 12.5, 10.4, 7.8, 6.3, 5.2, 3.9, 3.1, 2.6

Execution conditions

- Command execution occurs on combo box selection
- Push button **Set Values** is pressed

Module Command

- `radio set rxbw 62.5`

Error Coding

FIGURE 12-103: ERROR CODING RATE COMBO BOX

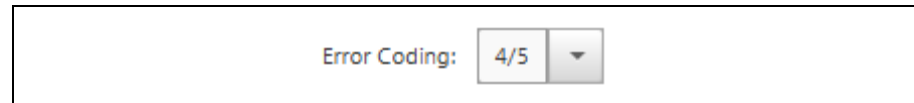

Description

This combo box is used to configure the Coding Rate currently being used by the radio ([Figure 12-103](#)).

Combo Box options

- 4/5, 4/6, 4/7, 4/8

Execution conditions

- Command execution occurs on combo box selection
- Push button **Set Values** is pressed

Module Command

- `radio set cr 4/7`

Automatic Frequency Correction Bandwidth

FIGURE 12-104: AFC BANDWIDTH COMBO BOX

AFC Bandwidth: 41.7 ▼

Description

This combo box is used to configure the Bandwidth applied to Automatic Frequency Correction band ([Figure 12-104](#)).

Combo Box options

- 250, 200, 166.7, 125, 100, 83.3, 62.5, 50, 41.7, 31.3, 25, 20.8, 15.6, 12.5, 10.4, 7.8, 6.3, 5.2, 3.9, 3.1, 2.6

Execution conditions

- Command execution occurs on combo box selection
- Push button **Set Values** is pressed

Module Command

- `radio set rxbw 41.7`

Modulation Mode

FIGURE 12-105: MODULATION COMBO BOX

Mod Mode: lora ▼

Description

This combo box is used to configure the method of signal modulation being used by the radio transceiver ([Figure 12-105](#)).

Combo Box options

- LoRa, FSK

Execution conditions

- Command execution occurs on combo box selection
- Push button **Set Values** is pressed

Module Command

- `radio set mod fsk`

Frequency

FIGURE 12-106: RADIO FREQUENCY TEXT FIELD

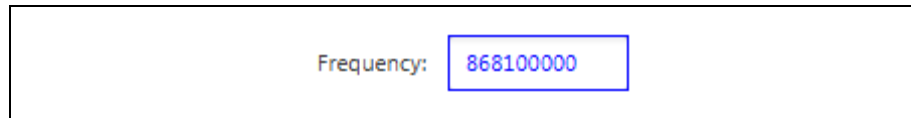

A screenshot of a text input field. The label "Frequency:" is positioned to the left of the input box. The input box contains the numerical value "868100000". The input box has a blue border.

Description

This text field configures the center frequency currently being used by the RN Module radio ([Figure 12-106](#)). The entered value must be within the valid range for the connected End-Device type.

Valid Range

- RN2483: 863000000 – 870000000
- RN2903: 902000000 – 928000000

Execution conditions

- Execution occurs when **Enter** is pressed in the field
- Push button **Set Values** is pressed

Module Command

- `radio set freq 923456789`

Invert IQ Enable

FIGURE 12-107: INVERT IQ CHECKBOX

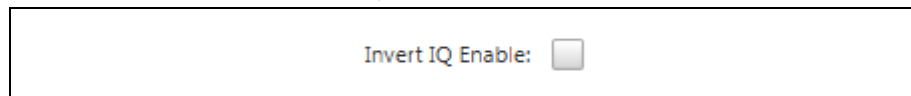

A screenshot of a checkbox control. The label "Invert IQ Enable:" is positioned to the left of the checkbox. The checkbox is currently unchecked.

Description

The checkbox is used to enable/disable the use of Invert IQ functionality by the RN Module radio ([Figure 12-107](#)).

Execution conditions

- Left click on box to alter Invert IQ usage On/Off
- Push button **Set Values** is pressed

Module Commands

- `radio set iqi off`

Frequency Deviation

FIGURE 12-108: FREQUENCY DEVIATION TEXT FIELD

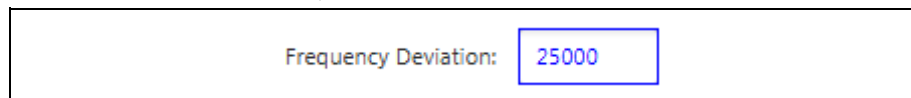

A screenshot of a text input field. The label "Frequency Deviation:" is positioned to the left of the input box. The input box contains the numerical value "25000". The input box has a blue border.

Description

This text field configures the allowed deviation from the specified center frequency of the RN Module radio ([Figure 12-108](#)).

Valid Range

- 0 – 200000

Execution conditions

- Execution occurs when **Enter** is pressed in the field
- Push button **Set Values** is pressed

Module Command

- `radio set freq 25000`

Watchdog Timer

FIGURE 12-109: WATCHDOG TIMER TEXT FIELD

The image shows a text input field with the label "WatchDog Timer:" and the value "15000" entered. The field is highlighted with a blue border.

Description

This text field configures the length used by the radio for a Watchdog Time-out condition to occur ([Figure 12-109](#)).

Valid Range

- 0 – 4294967295

Execution conditions

- Execution occurs when **Enter** is pressed in the field
- Push button **Set Values** is pressed

Module Command

- `radio set wdt 29000`

Frequency Shift Keying Bit Rate

FIGURE 12-110: BIT RATE TEXT FIELD

The image shows a text input field with the label "(G)FSK BitRate:" and the value "50000" entered. The field is highlighted with a blue border.

Description

This text field configures the length bit rate for when Frequency Shift Keying (FSK) communications are performed ([Figure 12-110](#)).

Valid Range

- 0 – 300000

Execution conditions

- Execution occurs when **Enter** is pressed in the field
- Push button **Set Values** is pressed

Module Command

- `radio set bitrate 29000`

Spreading Factor

FIGURE 12-111: RADIO SPREADING FACTOR COMBO BOX

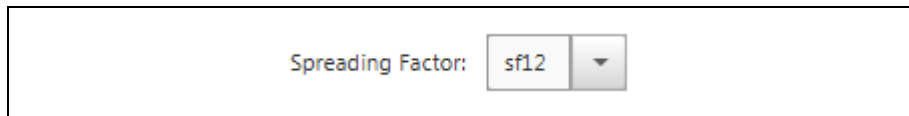

The screenshot shows a rectangular window with a light gray background. On the left side, the text "Spreading Factor:" is displayed in a standard font. To the right of this text is a small rectangular control element consisting of a text box containing "sf12" and a downward-pointing arrow button.

Description

This combo box modifies the radio Spreading Factor parameter value (Figure 12-111).

Combo Box options

- SF7, SF8, SF9, SF10, SF11, SF12

Execution conditions

- Command execution occurs on combo box selection
- Push button **Set Values** is pressed

Module Command

- `radio set sf SF9`

Preamble Length

FIGURE 12-112: HEADER PREAMBLE LENGTH TEXT FIELD

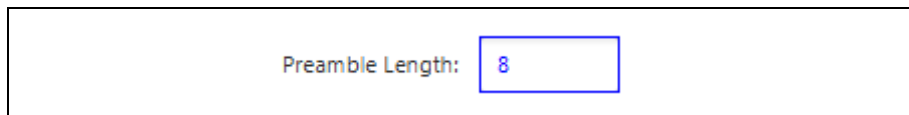

The screenshot shows a rectangular window with a light gray background. On the left side, the text "Preamble Length:" is displayed. To the right of this text is a text input field with a blue border, containing the number "8".

Description

This text field configures the preamble length applied to the header when issuing a transmission from the RN Module (Figure 12-112).

Valid Range

- 0 – 65535

Execution conditions

- Execution occurs when **Enter** is pressed in the field
- Push button **Set Values** is pressed

Module Command

- `radio set prlen 10`

Radio Sync Word

FIGURE 12-113: RADIO SYNC WORD TEXT FIELD

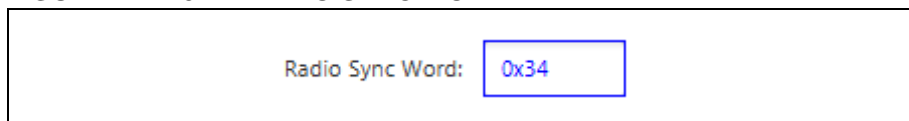

The screenshot shows a rectangular window with a light gray background. On the left side, the text "Radio Sync Word:" is displayed. To the right of this text is a text input field with a blue border, containing the hexadecimal value "0x34".

Description

This text field configures the radio sync word contained in the header when issuing transmission packets (Figure 12-113). The sync word is usually used to filter between public and private networks.

Valid Range

- 0 – 65535

Execution conditions

- Execution occurs when **Enter** is pressed in the field
- Push button **Set Values** is pressed

Module Command

- `radio set sync 34`

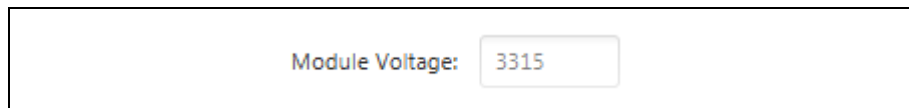
Module Voltage**FIGURE 12-114: MODULE VOLTAGE DISPLAY****Description**

This text field is non-editable and is used to display the current voltage (mV) the RN Module is being supplied ([Figure 12-114](#)).

Valid Range

- 0 – 3600

Execution conditions

- **Radio** Tab Selection
- Push button **Get Values** is pressed

Module Command

- `radio get vdd`

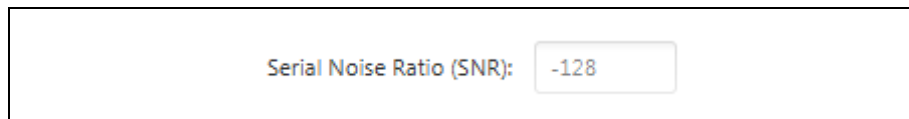
Serial Noise Ratio (SNR)**FIGURE 12-115: SERIAL NOISE RATIO DISPLAY****Description**

This text field is non-editable and is used to display the Signal Noise Ratio (SNR) of the last received packet ([Figure 12-115](#)).

Valid Range

- 128 – 127

Execution conditions

- **Radio** Tab Selection
- Push button **Get Values** is pressed

Module Command

- `radio get snr`

GPIO Control Titled Pane

FIGURE 12-116: GPIO CONTROLLER TITLED PANE



Description

Collapsible titled pane ([Figure 12-116](#)) containing organizing configurable Radio parameters in clearly displayed layout.

Execution conditions

- Left click on field

GPIO Pin

FIGURE 12-117: GPIO PIN COMBO BOX



Description

This combo box `<pinGPIO>` selects which GPIO pin on the RN Module to interact with ([Figure 12-117](#)).

Combo Box options

- GPIO0 – GPIO13, UART_CTS, UART_RTS, TEST0, TEST1

Execution conditions

- Command execution occurs on combo box selection
- Push button **Set Values** is pressed

Module Command

- `radio get pindig <pinGPIO>`
- `radio get pinana <pinGPIO>`
- `radio set pindig <pinGPIO> 0`

GPIO Mode

FIGURE 12-118: GPIO MODE COMBO BOX



Description

This combo box `<pinMode>` modifies if the currently select GPIO is currently in Digital Input, Digital Output, or Analog Input mode ([Figure 12-118](#)).

Combo Box options

- digout, digin, ana

GPIO Analog support

- GPIO0 – GPIO3, GPIO5 – GPIO 13

Execution conditions

- Command execution occurs on combo box selection
- Push button **Set Values** is pressed

Module Command

- `radio get <pinMode> GPIO10`
- `radio set pindig GPIO10 1`
- // Can only be set as Digital Output

Set/Refresh GPIO Value

FIGURE 12-119: GPIO SET VALUE PUSH BUTTON



Description

This push button is used to either Set or Refresh current GPIO values (Figure 12-119). In Digital Input and Analog mode, the button will read “Refresh”, while it will read “Set” for Digital Output.

Execution conditions

- On press

Module Command

- `sys get pinana GPIO10`
- `sys set pindig GPIO7 1`

GPIO Value Field

FIGURE 12-120: GPIO VALUE DISPLAY

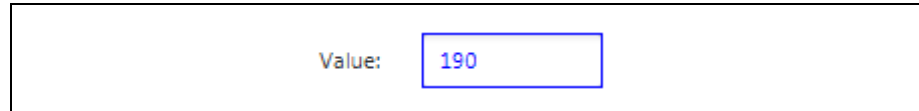

Description

This text field is editable only when digout is selected as the GPIO mode of operation (Figure 12-120). Otherwise the field is read-only, and will be updated upon GPIO pin selection.

Valid Input Range

- 0, 1

Valid Display Range

- 0 - 255

Execution conditions

- GPIO pin selection
- Issues command when **Enter** is pressed in Text Field
- Push button **Get Values** is pressed

Module Command

- `radio get pinana GPIO00`

Sleep Titled Pane

FIGURE 12-121: MODULE SLEEP TITLED PANE



Description

Collapsible titled pane (Figure 12-121) containing interactive elements capable of requesting the RN Module enter into Sleep mode operation for a specified length of time.

Execution conditions

- Left click on field

Sleep

FIGURE 12-122: SLEEP PUSH BUTTON

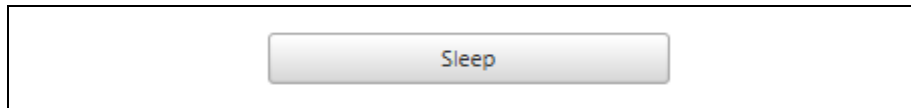

Description

This push button is used to issue a Sleep request to connected RN Module (Figure 12-122). The RN Module will not respond with "OK" until after it wakes from Sleep.

Execution conditions

- On press

Module Command

- `sys sleep 22000`

Sleep Length Field

FIGURE 12-123: SLEEP LENGTH TEXT FIELD

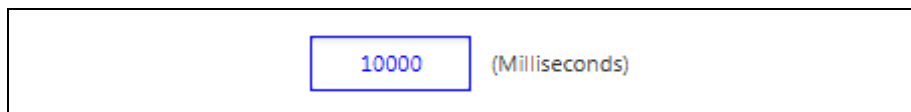

Description

This text field is the length of time (in milliseconds) that the RN Module will be requested to Sleep (Figure 12-123). The RN Module will not respond with "OK" until after it wakes from Sleep.

Valid Range

- 100 - 4294967296

Execution conditions

- Issues command when **Enter** is pressed in Text Field
- Push button **Set Values** is pressed

Module Command

- `sys sleep 10000`

Nonvolatile Memory Titled Pane

FIGURE 12-124: NONVOLATILE MEMORY TITLED PANE

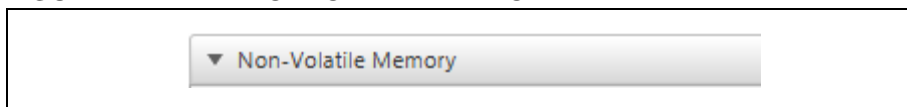

Description

Collapsible titled pane containing interactive elements capable of reading or writing to select available nonvolatile memory stored on the RN Module (Figure 12-124).

Execution conditions

- Left click on field

Address Field

FIGURE 12-125: MEMORY ADDRESS TEXT FIELD

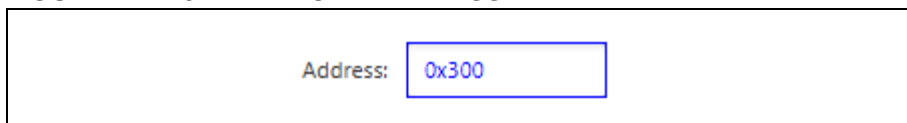

Description

This text field is the address in the RN Module's Nonvolatile Memory which is being accessed (Figure 12-125).

Valid Range

- 0x0300 – 0x03FF

Execution conditions

- Push button **Set** is pressed in Nonvolatile Memory titled pane

Module Command

- `sys set nvm 300 A5`

Data Field

FIGURE 12-126: MEMORY DATA TEXT FIELD

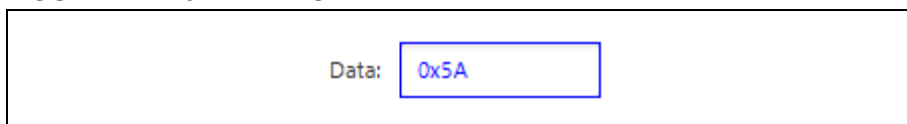

Description

This text field is the data related to the RN Module's Nonvolatile Memory address which is being accessed (Figure 12-126).

Valid Range

- 0x00 – 0xFF

Execution conditions

- Push button **Set** is pressed in Nonvolatile Memory titled pane

Module Command

- `sys set nvm 3FF A5`

Get/Set Nonvolatile Memory

FIGURE 12-127: GET MEMORY DATA PUSH BUTTON

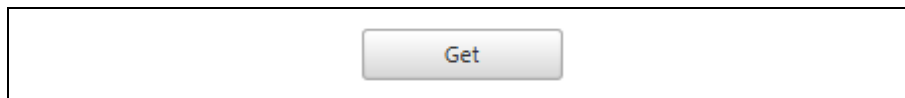

Description

This push button is used to read the data currently stored at the request Nonvolatile Memory Address location ([Figure 12-127](#)).

Execution conditions

- On press

Module Command

- `sys get nvm 0300`

General Titled Pane

FIGURE 12-128: GENERAL TITLED PANE



Description

Collapsible titled pane ([Figure 12-128](#)) containing push buttons capable of read or write actions to all parameter configurations specified to all fields under the Module Features titled pane.

Execution conditions

- Left click on field

Set Values

FIGURE 12-129: SET PARAMETER VALUES PUSH BUTTON

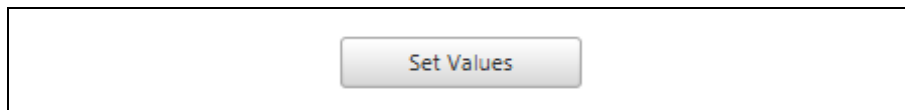

Description

This push button is used to set all RN Module radio parameters as they currently are shown in the development suite ([Figure 12-129](#)).

Execution conditions

- On press

Module Command

- `radio set pwr 3`
- `radio set bw 500`
- `radio set rxbw 200`
- `radio set afcbw 41.7`
- `radio set freq 923456789`
- `radio set fdev 25000`
- `radio set bitrate 50000`
- `radio set prlen 8`
- `radio set bt 0.5`

- radio set crc on
- radio set cr 4/7
- radio set mod fsk
- radio set iqf off
- radio set wdt 15000
- radio set sf sf12
- radio set sync 34

Get Values

FIGURE 12-130: REFRESH PARAMETER VALUES PUSH BUTTON

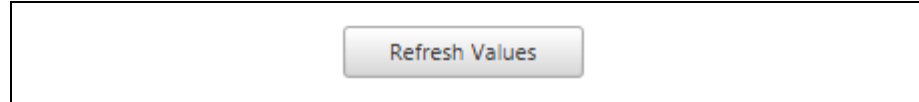

Description

This push button is used to get all RN Module radio parameters currently stored on the End Device ([Figure 12-130](#)).

Execution conditions

- On press

Module Command

- radio get pwr
- radio get bw
- radio get rxbw
- radio get afcbw
- radio get freq
- radio get fdev
- radio get bitrate
- radio get prlen
- radio get bt
- radio get crc
- radio get cr
- radio get mod
- radio get iqf
- radio get wdt
- radio get sf
- radio get sync

Transceiver Communication Titled Pane

FIGURE 12-131: RADIO TRANSCEIVER COMMUNICATION TITLED PANE

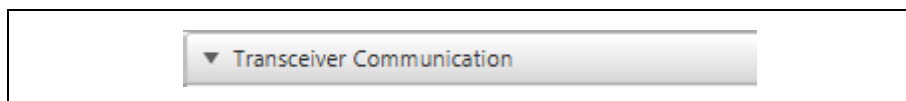

Description

Collapsible titled pane ([Figure 12-131](#)) with all elements related to communication between RN Modules without the use of the LoRaWAN protocol.

Execution conditions

- Left click on field

Transmit Titled Pane

FIGURE 12-132: RADIO TRANSMIT TITLE PANE



Description

Collapsible titled pane ([Figure 12-132](#)) with all elements capable of issuing a Transmission from the transceiver populated on the RN Module.

Execution conditions

- Left click on field

Issue Transmission

FIGURE 12-133: RADIO TRANSMIT PUSH BUTTON



Description

This push button is used to issue a transmission from the RN Module without using the LoRaWAN protocol ([Figure 12-133](#)).

Execution conditions

- On press

Module Command

- mac pause
- radio tx 123
- mac resume

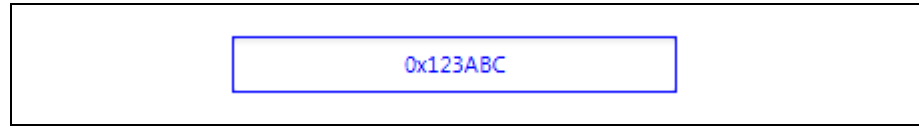
Data Payload**FIGURE 12-134: RADIO PAYLOAD TEXT FIELD****Description**

This text field is used to write the data that will be transmitted without use of the LoRaWAN protocol (Figure 12-134).

Valid Range

- 0 - 99999999999999999999999999999999

Execution conditions

- Issue Transmission on button press

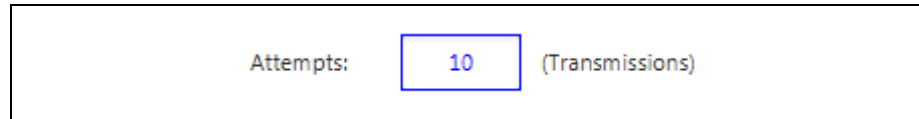
Transmission Attempts**FIGURE 12-135: RADIO TRANSMISSION ATTEMPTS TEXT FIELD****Description**

This text field is used to determine the number of transmit packets that will be issued with the Data Payload attempts (Figure 12-135).

Valid Range

- 0 - 255

Execution conditions

- Issue Transmission on button press

Receive Titled Pane**FIGURE 12-136: RADIO RECEIVE TITLED PANE****Description**

Collapsible titled pane (Figure 12-136) with all elements capable of receiving transmissions captured by the transceiver used by the RN Module.

Execution conditions

- Left click on field

Receive Window Length

FIGURE 12-137: RECEIVE WINDOW LENGTH TEXT FIELD



The image shows a text input field with the label "Window Length:" on the left. The input field contains the number "15000" and is followed by the text "(Milliseconds)". The input field is highlighted with a blue border.

Description

This text field is the window length of time the RN Module will attempt to listen for none LoRaWAN Protocol transmission ([Figure 12-137](#)).

Valid Range

- 0 - 65000

Execution conditions

- Issue on **Listen** push button press

Listen to Receive

FIGURE 12-138: BEGIN LISTEN PUSH BUTTON

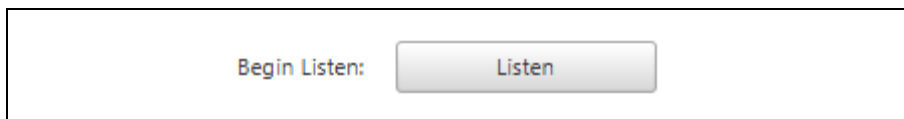

The image shows a push button labeled "Listen" next to the text "Begin Listen:". The button is a light gray color with rounded corners.

Description

This push button will put the RN Module into Listen mode for the length of time specified in the Listen Length field ([Figure 12-138](#)). The RN Module reception period will either elapse allowing a time-out message to be returned, or a valid transmission will be captured.

Execution conditions

On Press

Module Command

- radio rx <windowLength>

Infinite Receive Window

FIGURE 12-139: INFINITE RECEIVE WINDOW PUSH BUTTON

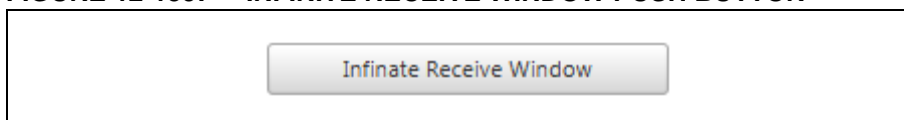

The image shows a push button labeled "Infinite Receive Window". The button is a light gray color with rounded corners.

Description

This push button will put the RN Module into Permanent Listen mode ([Figure 12-139](#)). It will pause all interaction with the RN Module until a valid transmission is captured.

Execution conditions

- On Press

Module Command

- radio rx 0

12.3.5 RN Module Device Firmware Update (DFU) Tab Descriptions

Below are the interactive elements of the **Radio** tab inside the RN Module Device Model, as represented in [Figure 12-140](#):

1. Bootloader Input
2. File Selection
3. Directory Browser
4. COM Port Settings
5. Bits per second
6. Data bits
7. Stop bits
8. Parity
9. Update Firmware

Note: When using Bootloader Recovery, the DFU will be the only Model View available for the COM Device Model Type. Behavior of the **DFU** Tab does not differ between Device Models: RN Module and COM.

FIGURE 12-140: RN MODULE RADIO DFU LAYOUT

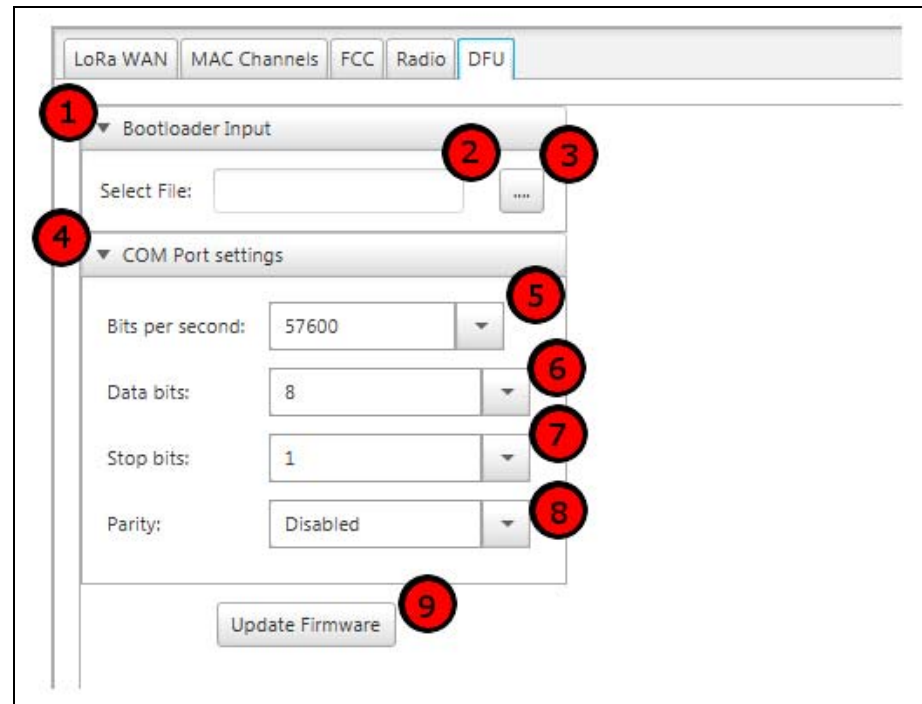

Bootloader Input

FIGURE 12-141: BOOTLOADER INPUT TITLED PANE

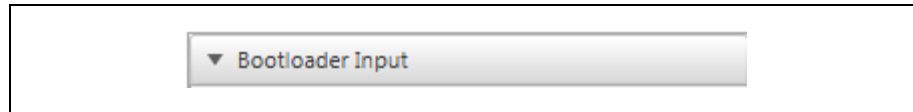

Description

Collapsible titled pane (Figure 12-141) allowing the user to browse directories, and select the new Device Firmware file for updating.

Execution conditions

- Left click on field

File Selection

FIGURE 12-142: SELECT HEX FILE DISPLAY FIELD

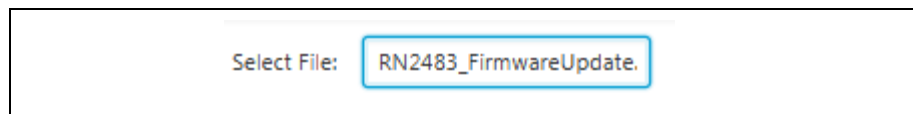

Description

This field is used to display the currently selected file which will be updated onto the target device (Figure 12-142).

Execution conditions

- This field is populated after the user selects a file using the Directory Browser.

Directory Browser

FIGURE 12-143: DIRECTORY BROWSER PUSH BUTTON



Description

This push button will request the user to select the .Hex file which will be updated onto the target device (Figure 12-143). A Breakout window will appear upon button press (Figure 12-144); this will allow the user to browse and select the target file.

Execution conditions

- Breakout window opens on press.

FIGURE 12-144: FILE SELECTION

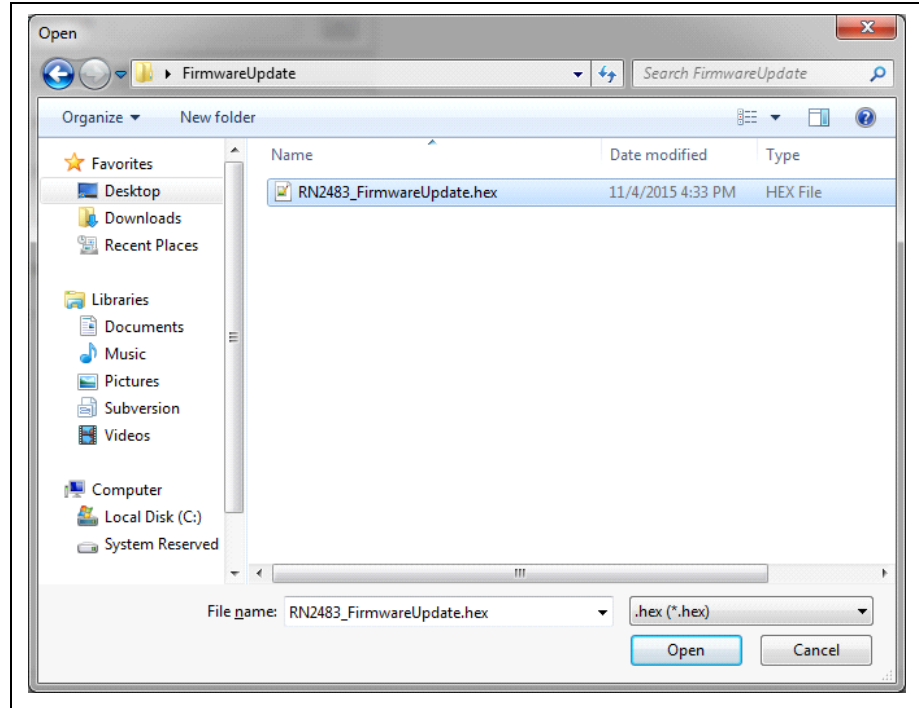

COM Port Settings

FIGURE 12-145: COM PORT SETTING TITLED PANE

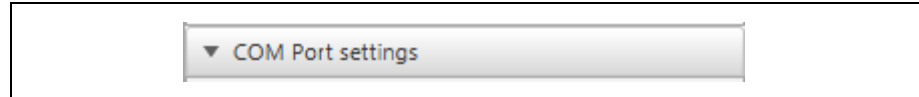

Description

Collapsible titled pane (Figure 12-145) used to configure COM PORT communication settings.

Execution conditions

- Left click on field

Bits per Second

FIGURE 12-146: BAUD RATE COMBO BOX



Description

This combo box is used to determine the Bits per Second, or Baud Rate, which will be used during the bootloading process (Figure 12-146). This represents the desired Baud Rate, when attempting to recalibrate with the target device using auto-baud functionality. Supported Baud Rate of the target device determines the communication speed which should be selected. By default for the RN Module Bootloader this is 57600.

Combo Box options

- 9600, 19200, 57600, 115200

Execution conditions

- Baud Rate used when **Update Firmware** button is pressed.

Data Bits

FIGURE 12-147: DATA BITS COMBO BOX



The image shows a graphical user interface element for configuring data bits. It consists of a rectangular box containing the text "Data bits:" followed by a text input field containing the number "8" and a small downward-pointing arrow on the right side, indicating a dropdown menu.

Description

This combo box is used to configure the number of Data Bits used for Data Transfer during the device firmware update ([Figure 12-147](#)). By default the number is 8 for the RN Module Bootloader.

Combo Box options

- 4, 5, 6, 7, 8

Execution conditions

- Data Bits used when **Update Firmware** button is pressed

Stop Bits

FIGURE 12-148: STOP BITS COMBO BOX



The image shows a graphical user interface element for configuring stop bits. It consists of a rectangular box containing the text "Stop bits:" followed by a text input field containing the number "1" and a small downward-pointing arrow on the right side, indicating a dropdown menu.

Description

This combo box is used to configure the number of Stop bits used as the Stop indicator during the device firmware update ([Figure 12-148](#)). By default the number is 1 for the RN Module Bootloader.

Combo Box options

- 1, 1.5, 2

Execution conditions

- Stop Bits used when **Update Firmware** button is pressed

Parity

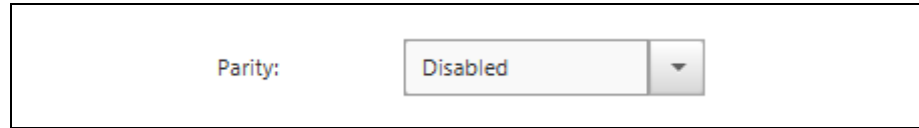
FIGURE 12-149: PARITY COMBO BOX**Description**

This combo box is used to select if the parity will be used during the bootloading byte process (Figure 12-149). By default this is Disabled for the RN Module Bootloader.

Combo Box options

- Enabled, Disabled

Execution conditions

- Parity used when **Update Firmware** button is pressed

Update Firmware

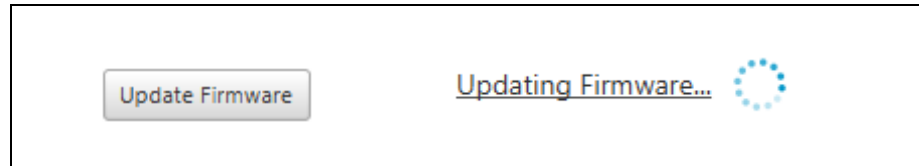
FIGURE 12-150: UPDATE FIRMWARE PUSH BUTTON**Description**

This push button is used to begin the Bootloading process (Figure 12-150). Settings should be configured prior to attempting the device firmware update.

Execution conditions

- Left click on button

LoRa[®] Technology Evaluation Suite User's Guide

NOTES:

Chapter 13. Gateways

13.1 OVERVIEW

Through use of the LoRa Development Utility it is possible to exercise every command supported by the LoRa Gateway core firmware through the presented visual interface. This allows those that have a good understanding of the LoRa system to configure and evaluate Gateway behavior without any knowledge of the ASCII command structures.

13.2 FEATURES

The Gateway model view is only a single tab used to configure the device, along with displaying current statistics at a set interval. The tab pane has been divided into multiple titled panels that may be collapsed when no longer required, to improve visual presentation and navigation. The GUI does not display the Radio board's operation bandwidth type, refer to the Gateway Core board version and configuration LCD display to observe frequency operation type.

13.3 DESCRIPTION

After selecting a Gateway unit from the Device List, the model viewer will populate the tab and fetch currently configured parameter values via 'get' commands.

For Boolean-based inputs, checkboxes are used. When multiple defined values are available, combo boxes are used. Text fields contain validators to help visually indicate if the current value entered into the text field is valid. An IP validator is additionally used to confirm proper format.

13.3.1 Gateway Tab Descriptions

Below are the interactive elements of the tab for the Gateway Device Model, as represented in [Figure 13-1](#):

1. Configuration
2. Board Setup
3. Gateway ID
4. IP Allocation Mode
5. Core Board IP
6. Network Router IP
7. Default Mask IP
8. Sync Word
9. Network Time Protocol IP Type
10. NTP IP Location
11. Use NTP IP
12. System Date
13. System Time
14. Configure Date/Time
15. Server Setup
16. LoRa Server IP
17. Server Up Port
18. Server Down Port
19. Keep Alive Interval
20. General
21. Configure All Parameters
22. Reload All Parameters
23. Save Setting to SD Card
24. Statistics Pane
25. Sever Connection Status
26. Update Interval
27. Polling Behavior
28. Polling Rate
29. Start/Stop Polling
30. Upstream Pane
31. Upstream Data
32. Downstream Pane
33. Downstream Data
34. Information Pane
35. Version
36. Build
37. Advanced Pane
38. Raw Terminal

FIGURE 13-1: GATEWAY TAB LAYOUT

The screenshot displays the Gateway configuration web interface, organized into several sections with numbered callouts (1-38) indicating specific elements:

- 1** Configuration (Section Header)
- 2** Core Board Setup (Section Header)
- 3** Gateway ID: 0x1234567887654321
- 4** IP Allocation Mode: Static DHCP
- 5** Core Board IP: 192.168.1.101
- 6** Network Router IP: 192.168.1.1
- 7** Default Mask IP: 255.255.255.0
- 8** Sync Word: 0x34
- 9** Network Time Protocol (NTP):
- 10** U.S. Default (utcrist2.colorado.edu) Custom IP
- 11** University of Colorado #2: 128.138.141.172 (Use NTP IP)
- 12** System Date: 2011-01-02 (Configure Date/Time)
- 13** System Time: 01:24:54 (Configure Date/Time)
- 14** (Configure Date/Time Button)
- 15** Server Setup (Section Header)
- 16** LoRa Server IP: 192.168.1.1
- 17** Server Port: Up: 1700 Down: 1700
- 18** (Server Port Fields)
- 19** Keep Alive Interval: 10 (Seconds)
- 20** General Actions (Section Header)
- 21** Config All Parameters
- 22** Reload Parameters
- 23** Save Settings to SD Card
- 24** Statistics (Section Header)
- 25** Server Connection: TimeOut
- 26** Update Interval: 30 (Seconds)
- 27** --- POLLING BEHAVIOR ---
- 28** Polling Rate: 5 (Seconds)
- 29** Start
- 30** --- UPSTREAM ---
- 31** Packets Received: 441
- CRC_OK: 0
- CRC_FAIL: 100
- NO_CRC: 0
- Packets Forwarded: 0
- Bytes: 0
- PUSH_DATA Sent: 2328
- Bytes: 56552
- PUSH_DATA ACKed: 0
- 32** --- DOWNSTREAM ---
- PULL Sent/ACK: 6988 0
- PULL Received: 0
- Bytes: 0
- Tx RF Packets Sent: 0
- Tx Errors: 0
- 34** Information (Section Header)
- 35** Microchip LoRa Gateway Version 1.0.0RC3
- 36** Built on Mar 18 2016 at 13:51:23
- 37** Advanced (Section Header)
- 38** Raw Terminal: [Text Input Field]

Configuration

FIGURE 13-2: CONFIGURATION TITLED PANE

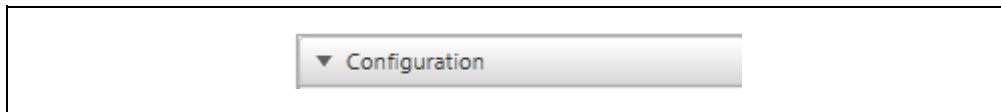

Description

Collapsible titled pane (Figure 13-2) used to contain all required configurable parameters, and settings required for Network interaction accessible through the supported Gateway commands.

Execution conditions

- Left click on field

Board Setup

FIGURE 13-3: BOARD SETUP TITLED PANE

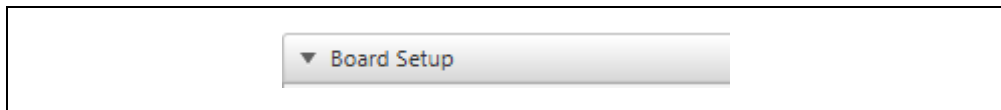

Description

Collapsible titled pane (Figure 13-3) used to contain available board configuration and behavior parameters.

Execution conditions

- Left click on field

Gateway ID

FIGURE 13-4: GATEWAY ID TEXT FIELD

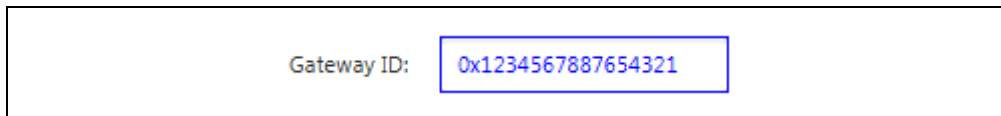

Description

This text field is used to configure the Gateway ID used by the selected device (Figure 13-4). The Gateway ID specified should be unique to the Network Server it is connected with.

Valid Range

- 0x0 – 0xFFFFFFFFFFFFFFFF

Execution conditions

- Issued upon **Enter** key press
- Issued upon **Configure All Parameters** button press
- Populated upon **Reload All Parameters** button press

Gateway Command

- `sys set gwid 1234567887654321`
- `sys get gwid`

IP Allocation Mode

FIGURE 13-5: IP ALLOCATION MODE BUTTON

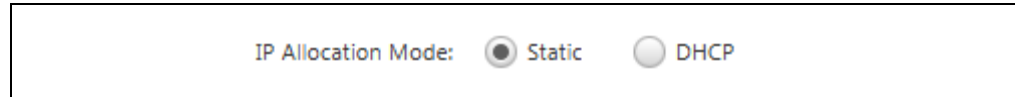

Description

This radio button allows the user to select the mode used for IP Allocation (Figure 13-5). Either the IP Address is DHCP, in which IP addresses are dynamically assigned by a DHCP server, or Static, in which case the Core Board IP, Network Router IP and Default Mask IP must be specified by the user during configuration.

Valid Range

- Static, DHCP

Execution conditions

- Issued upon selection
- Issued upon **Configure All Parameters** button press
- Populated upon **Reload All Parameters** button press

Gateway Command

- `sys set ifmode static`
- `sys get ifmode`

Core Board IP

FIGURE 13-6: CORE BOARD IP VALIDATOR

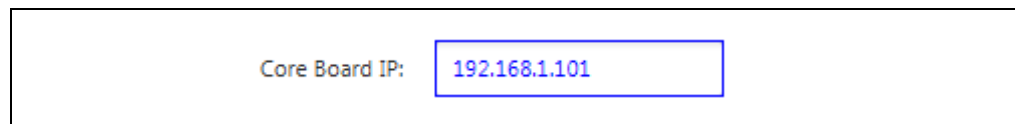

Description

This text field is used to specify the IP Address location allocated to the Gateway Core Board (Figure 13-6). This IP value is only required when using Static IP Allocation mode, and is not required for Dynamic mode. The set IP address must be unique within the Network.

Execution conditions

- Issued upon **Enter** key press
- Issued upon **Configure All Parameters** button press
- Populated upon **Reload All Parameters** button press

Gateway Command

- `sys set ifip 192.168.1.101`
- `sys get ifip`

Network Router IP

FIGURE 13-7: NETWORK ROUTER IP VALIDATOR

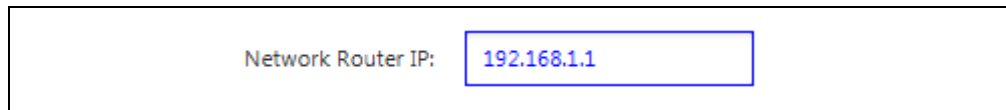

The screenshot shows a text input field with the label "Network Router IP:" and the value "192.168.1.1" entered. The input field is highlighted with a blue border.

Description

This text field is used to specify the IP Address of the Ethernet (IPv4) gateway. This IP value is only required when using a Static IP Allocation mode, and is not required for Dynamic mode. Typically this IP address is the Host PC, Router, or Switch the Gateway is connected to ([Figure 13-7](#)).

Execution conditions

- Issued upon **Enter** key press
- Issued upon **Configure All Parameters** button press
- Populated upon **Reload All Parameters** button press

Gateway Command

- `sys set ifgw 192.168.1.1`
- `sys get ifgw`

Default Mask IP

FIGURE 13-8: DEFAULT MASK IP VALIDATOR

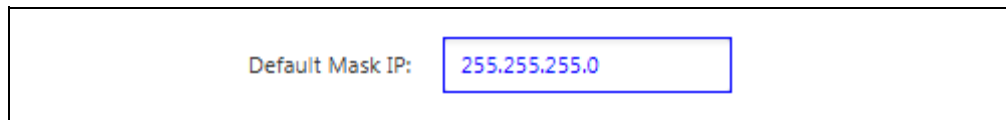

The screenshot shows a text input field with the label "Default Mask IP:" and the value "255.255.255.0" entered. The input field is highlighted with a blue border.

Description

This text field is used to specify the subnet mask of the Ethernet (IPv4) network. This IP value is only required when using Static IP Allocation mode, and is not required for Dynamic mode. Typically the default value of 255.255.255.0 is used ([Figure 13-8](#)).

Execution conditions

- Issued upon **Enter** key press
- Issued upon **Configure All Parameters** button press
- Populated upon **Reload All Parameters** button press

Gateway Command

- `sys set ifmsk 255.255.255.0`
- `sys get ifmsk`

Sync Word**FIGURE 13-9: SYNC WORD TEXT FIELD**

A screenshot of a web interface showing a text field labeled "Sync Word:" with the value "0x34" entered. The text field is highlighted with a blue border.

Description

This text field is used to configure the Gateway Sync Word used in the LoRa Header (Figure 13-9). Sync word setting between End Device and Gateway must match. Typically a value of 0x12 represents a private network, while 0x34 represents a public one.

Valid Range

- 0x0 – 0xFF

Execution conditions

- Issued upon **Enter** key press
- Issued upon **Configure All Parameters** button press
- Populated upon **Reload All Parameters** button press

Gateway Command

- `sys set sync 0x34`
- `sys get sync`

Network Time Protocol (NTP)**FIGURE 13-10: NETWORK TIME PROTOCOL RADIO BUTTONS**

A screenshot of a web interface for Network Time Protocol (NTP) configuration. It shows two sections. The left section has a radio button selected for "U.S. Default (utcnist2.colorado.edu)" and a text field containing "128.138.141.172". The right section has a radio button selected for "Custom IP" and a text field containing "132.163.4.101". Both sections have a "Use NTP IP" button.

Description

This radio button allows selection between getting time/data information from the default used NTP IP, University of Colorado 2, or from a Custom IP address (Figure 13-10).

Execution conditions

- Clicking on the Radio Button [U.S. Default]
- Press the **Use NTP IP** push button [Custom IP]
- Press **Enter** in Text Field [Custom IP]

Gateway Command

- `sys ntp` [U.S. Default; 128.138.141.72 is used]
- `sys ntp 132.163.4.101 (e.g)` [Custom IP]

NTP Date

FIGURE 13-11: NTP DATE TEXT FIELD



Description

This text field is used to display the currently received NTP Date information configured on the Gateway Unit (Figure 13-11). This Date can be custom configured. However, it is recommended to allow the value to be set by the NTP Server IP specified.

Execution conditions

- Press **Configure Date/Time** push button

NTP Time

FIGURE 13-12: NTP TIME TEXT FIELD

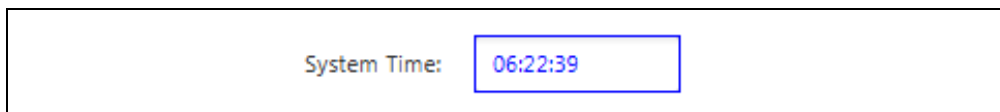

Description

This text field is used to display the currently received NTP Time information configured on the Gateway Unit (Figure 13-12). This Time can be custom configured. However, it is recommended to allow the value to be set by the NTP Server IP specified.

Execution conditions

- Press **Configure Date/Time** push button

NTP Date/Time

FIGURE 13-13: CONFIGURE DATE/TIME PUSH BUTTON

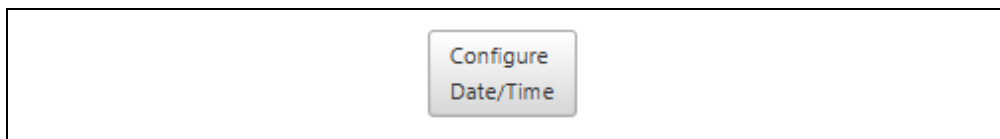

Description

This push button is used to configure both NTP Date and Time values (Figure 13-13). Values stored in the NTP Date and NTP Time text fields will be used to configure the Gateway parameters.

Execution conditions

- Press **Configure Date/Time** push button

Gateway Command

- `sys date 2011-01-01T06:22:39Z` [Configures Parameter]
- `sys date` [Returns current Parameter Values]

Note: z is used as a terminator for Date; T is used as the terminator for Time and end of command

Server Setup

FIGURE 13-14: SERVER SETUP TITLED PANE



Description

Collapsible titled pane (Figure 13-14), used to configure Server connection and interaction settings.

Execution conditions

- Left click on field

LoRa[®] Server IP

FIGURE 13-15: LoRa[®] SERVER IP VALIDATOR

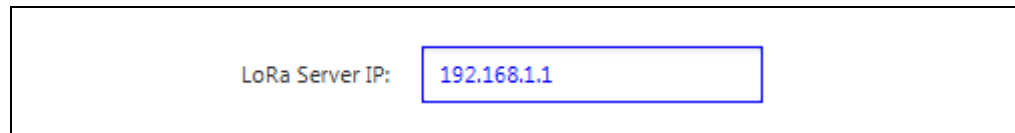

Description

This text field is used to specify the IP Address that is hosting the LoRa Servers (Figure 13-15). When connected directly to a Host PC that is operating in Static mode, this IP should match that used for the Network Router. If hosted in Network, this IP should match the Hosted IP Address for the server, where the Network Router IP will be different.

Execution conditions

- Issued upon **Enter** key press
- Issued upon **Configure All Parameters** button press
- Populated upon **Reload All Parameters** button press

Gateway Command

- `sys set svip 192.168.1.1`
- `sys get svip`

Server Up Port

FIGURE 13-16: SERVER UP PORT TEXT FIELD



Description

This text field is used to configure the Server Up Port number used by the Gateway to transmit Ethernet packets to the LoRa Server IP address (Figure 13-16).

Valid Range

- 0 - 65535

Execution conditions

- Issued upon **Enter** key press
- Issued upon **Configure All Parameters** button press
- Populated upon **Reload All Parameters** button press

Gateway Command

- `sys set svup 1700`
- `sys get svup`

Server Down Port

FIGURE 13-17: SERVER DOWN PORT TEXT FIELD



The screenshot shows a text input field with the label "Server Port: Down:" and the value "1700" entered. The input field is highlighted with a blue border.

Description

This text field is used to configure the Server Down Port number used by the Gateway to receive Ethernet packets from the LoRa Server IP address (Figure 13-17).

Valid Range

- 0 - 65535

Execution conditions

- Issued upon **Enter** key press
- Issued upon **Configure All Parameters** button press
- Populated upon **Reload All Parameters** button press

Gateway Command

- `sys set svdn 1700`
- `sys get svdn`

Keep Alive Interval

FIGURE 13-18: KEEP ALIVE INTERVAL TEXT FIELD

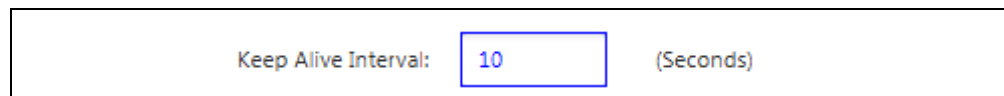

The screenshot shows a text input field with the label "Keep Alive Interval:" and the value "10" entered. The input field is highlighted with a blue border. The text "(Seconds)" is displayed to the right of the input field.

Description

This text field is used to configure the Keep Alive Interval; or the length of time in seconds before the Gateway checks connection status with the Server (Figure 13-18). After the configured length of time, the Gateway will issue a Pull request to the specified IP address to confirm its connection is still active.

Valid Range

- 0 – 65535

Execution conditions

- Issued upon **Enter** key press
- Issued upon **Configure All Parameters** button press
- Populated upon **Reload All Parameters** button press

Gateway Command

- `sys set heart 10`
- `sys get heart`

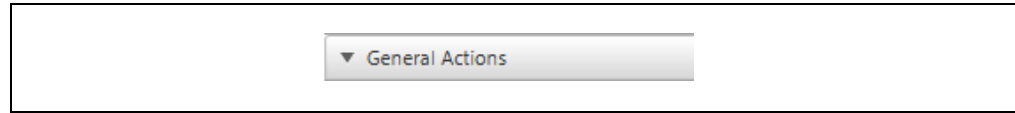
General**FIGURE 13-19: GENERAL TITLED PANE****Description**

Collapsible titled pane ([Figure 13-19](#)), containing buttons used to reload all currently stored Gateway parameter settings, update all settings with the values specified through the GUI fields, or to save all current settings to an SD card if present on the Gateway.

Execution conditions

- Left click on field

Configure All Parameters**FIGURE 13-20: CONFIG ALL PARAMETERS PUSH BUTTON****Description**

This push button is used to configure all Gateway parameters according to the values; or states displayed in the GUI model view ([Figure 13-20](#)). All information will be parsed from the fields, and formatted according to Gateway Command expected structure before being issued to the selected Gateway unit.

Execution conditions

- Left click on button

Gateway Command

- `sys set gwid 0x1234567887654321`
- `sys set ifip 192.168.1.101`
- `sys set ifgw 192.168.1.1`
- `sys set ifmsk 255.255.255.0`
- `sys set svip 192.168.1.1`
- `sys set svup 1700`
- `sys set svdn 1700`
- `sys set ifmode static`
- `sys set crc on`
- `sys set crcvd on`
- `sys set crcer off`
- `sys set stat 30`
- `sys set heart 10`
- `sys set sync 0x34`
- `sys save`

Reload All Parameters

FIGURE 13-21: RELOAD PARAMETERS PUSH BUTTON

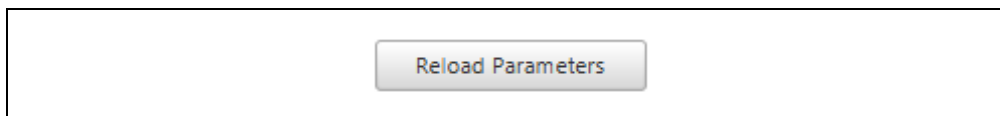

Description

This push button is used to capture current Gateway parameter settings, and then populate values; or states into the appropriate GUI model view fields ([Figure 13-21](#)).

Execution conditions

- Left click on button

Gateway Command

- `sys get build`
- `sys get gwid`
- `sys get ifmode`
- `sys get ifip`
- `sys get ifgw`
- `sys get ifmsk`
- `sys get svip`
- `sys get svup`
- `sys get svdn`
- `sys get crc`
- `sys get crcvd`
- `sys get crcer`
- `sys get stat`
- `sys get heart`
- `sys get sync`

Save Settings to SD Card

FIGURE 13-22: SAVE SETTINGS TO SD CARD PUSH BUTTON

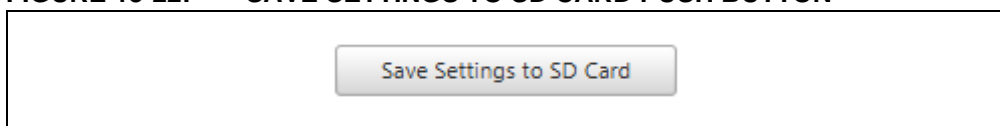

Description

This push button is used to attempt a save of all parameter settings to a microSD card if present within the Gateway Board ([Figure 13-22](#)). Response to the command will either indicate “Success” or “Fail”. Parameter values saved to the SD card will automatically be used to configure the Gateway upon power-on.

Execution conditions

- Left click on button

Gateway Command

- `sys save`

Statistics Pane**FIGURE 13-23: STATISTICS TITLED PANE****Description**

Collapsible titled pane (Figure 13-23) useful for a glance at statistics information related to the connected Gateway device.

Execution conditions

- Left click on field

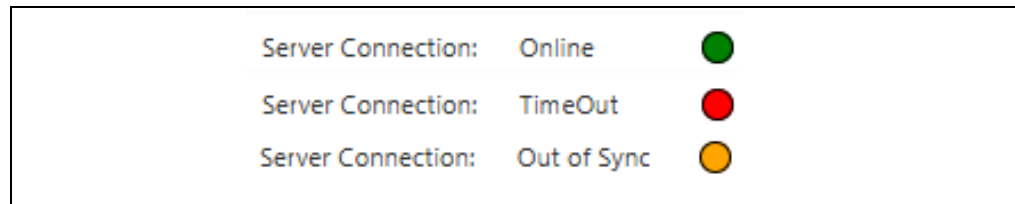
Server Connection Status**FIGURE 13-24: SERVER CONNECTION STATUS LABEL & INDICATOR****Description**

These label and circle indicators are used to reflect the current status of the Gateway's connection to the LoRa Server (Figure 13-24). For these indicators to update properly, Statistics Polling is required to be running. Indication of Server connection status is the final byte of the `sys report` command.

Execution conditions

- Gateway Statistics Polling should be active

QA

- Out of Sync – Check Ethernet cable connection, and Network Adapter settings.
- Time out – Confirm Server is running in Docker, verify all port forwarding settings.
- Online – Gateway is communication with server properly.

Upload Interval**FIGURE 13-25: UPLOAD INTERVAL TEXT FIELD****Description**

This text field is used to configure the Statistics Interval; or the length of time (in seconds) before the Gateway Unit updates the displayed statistics information (Figure 13-25). At this rate, the GUI will issue a Report request and populate the appropriate labels within the Upstream/Downstream statistics information.

Valid Range

- 0 - 65535

Execution conditions

- Issued upon **Enter** key press
- Issued upon **Configure All Parameters** button press
- Populated upon **Reload All Parameters** button press

Gateway Command

- `sys set stat 30`
- `sys get stat`

Polling Behavior

FIGURE 13-26: POLLING BEHAVIOR TITLED PANE

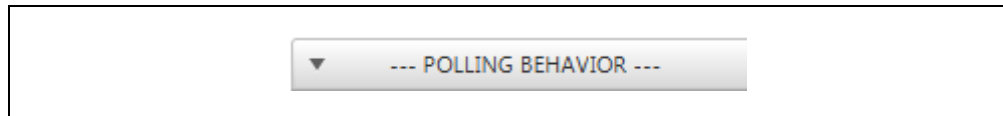

Description

Collapsible titled pane ([Figure 13-26](#)) useful to configure the rate at which statistics information is requested from the selected Gateway Unit.

Execution conditions

- Left click on field

Statistics Polling Rate

FIGURE 13-27: STATISTICS POLLING RATE TEXT FIELD

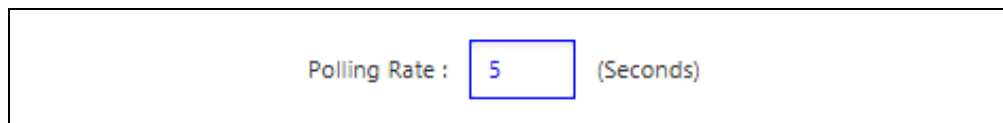

Description

This text field is used to configure the Polling Rate in seconds used by the Utility to request Report information back from the Gateway ([Figure 13-27](#)).

Execution conditions

- **Enter** in the text field will set the Device Model variable value
- Pressing **Start/Stop** push button will activate/deactivate the polling process

Start/Stop Polling

FIGURE 13-28: START/STOP POLLING PUSH BUTTON

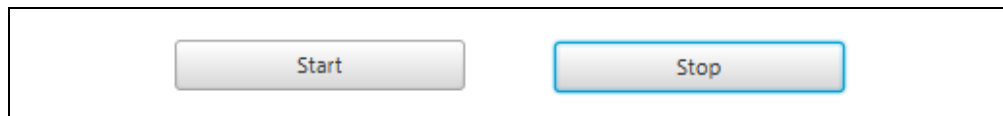

Description

This push button is used to begin the polling system used to capture and display Gateway Report statistics ([Figure 13-28](#)). If active, the push button will read Stop instead of Start. At the polling rate specified in the Update Interval field, a `sys get report` command will be issued by the GUI to the Gateway unit.

Execution conditions

- Left click on button

Gateway Command

- `sys set stat 30`
- `sys get stat`
- `sys get report` (Issued per Update Interval time length)

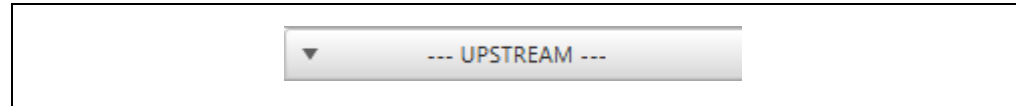
Upstream Pane**FIGURE 13-29: UPSTREAM TITLED PANE****Description**

Collapsible titled pane (Figure 13-29) used to display current upstream statistics information

Execution conditions

- Left click on field

Upstream Data**FIGURE 13-30: UPSTREAM DATA DISPLAY**

Packets Received:	1
CRC_OK:	0
CRC_FAIL:	100
NO_CRC:	0
Packets Forwarded:	0
Bytes:	0
PUSH_DATA Sent:	1
Bytes:	107
PUSH_DATA ACKed:	0

Description

The Upstream Data is constructed of labels and no interaction is required by the user. Based upon the requested Report, the appropriate labels will be populated (Figure 13-30). Requesting a Report will result in response string of 16-byte length containing formatted data.

Report Byte Correlation

- Byte [1] – Packets Received
- Byte [2] – CRC OK
- Byte [3] – CRC FAIL
- Byte [4] – NO CRC
- Byte [5] – Packets Forwarded
- Byte [6] – Bytes
- Byte [7] – Push Data Sent
- Byte [8] – Bytes
- Byte [9] – Push Data Acknowledged

Downstream Pane

FIGURE 13-31: DOWNSTREAM TITLED PANE

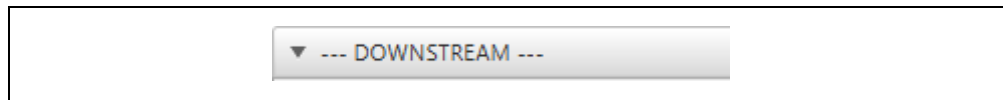

Description

Collapsible titled pane (Figure 13-31) used to display current downstream statistics information

Execution conditions

- Left click on field

Downstream Data

FIGURE 13-32: DOWNSTREAM DATA DISPLAY

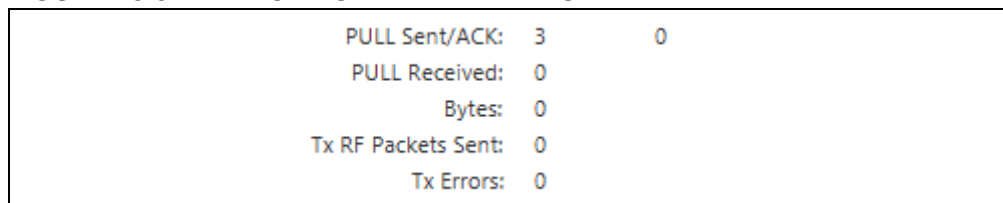

PULL Sent/ACK:	3	0
PULL Received:	0	
Bytes:	0	
Tx RF Packets Sent:	0	
Tx Errors:	0	

Description

The Downstream Data is constructed of labels and no interaction is required by the user. Based upon the requested Report, the appropriate labels will be populated (Figure 13-32). Requesting a Report will result in response string of 16-byte length containing formatted data.

Report Byte Correlation

- Byte [10] – Pull Request Attempts Sent
- Byte [11] – Pull Acknowledgments
- Byte [12] – Pull Request Received
- Byte [13] – Bytes Received
- Byte [14] – Transmit Radio Frequency Packets Sent
- Byte [15] – Transmit Errors occurred

Information Pane

FIGURE 13-33: INFORMATION TITLED PANE

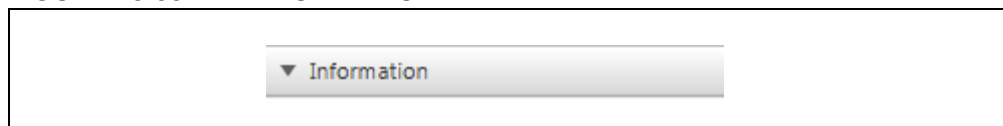

Description

Collapsible titled pane (Figure 13-33) displays program version and build information related to the connected Gateway board.

Execution conditions

- Left click on field

Version

FIGURE 13-34: LoRa® GATEWAY VERSION DISPLAY



Description

Label used to display the version information related to the selected Gateway (Figure 13-34).

Execution conditions

- Populated on Device Creation

Gateway Command

- `sys get ver`

Build

FIGURE 13-35: LoRa® GATEWAY BUILD TIME DISPLAY

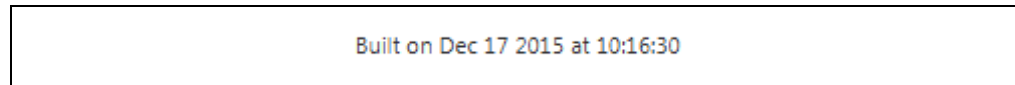

Description

Label used to display the program board Build information related to the selected Gateway (Figure 13-35).

Execution conditions

- Populated on **Device Creation**
- Populated upon **Reload All Parameters** button press

Gateway Command

- `sys get build`

Advanced Pane

FIGURE 13-36: ADVANCED TITLED PANE



Description

Collapsible titled pane (Figure 13-36) containing a Raw Terminal for Serial COM Port emulation used to issue Gateway Commands directly.

Execution conditions

- Left click on field

Raw Terminal

FIGURE 13-37: RAW TERMINAL TEXT FIELD

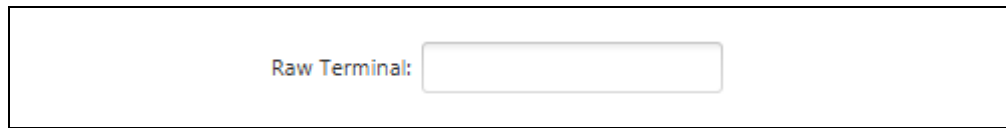
A screenshot of a web interface showing a text input field. The text "Raw Terminal:" is displayed in a light gray font to the left of a white rectangular input box with a thin gray border. The entire input area is enclosed in a larger, thin black rectangular frame.

Description

The text field is used to directly write commands to the Gateway ([Figure 13-37](#)). Use of this text field is for those with advanced knowledge of the full Gateway command syntax.

Execution conditions

- Issued upon **Enter** button pressed in Text Field

Chapter 14. Gateway Behavior Operation

14.1 OVERVIEW

The LoRa Gateway is an evaluation board intended to be used along with the development of applications and products which utilize one of the LoRa Technology Transceiver RN Modules.

The Microchip LoRa Gateway provides communication with the Microchip supported Evaluation LoRa server. Uplink packets issued according to the LoRa WAN specification are captured and forwarded by Microchip's Gateway. Microchip supplies multiple Gateway Radio boards, each with its own designated frequency band of operations to support the available Microchip RN Modules. Communication with the specified server is achieved through TCP/IP protocol as supported by the demonstration board hardware.

14.2 POWER AND COMMUNICATION CONNECTIONS

14.2.1 USB

If a micro-USB cable is connected to the LoRa Gateway Core board (J2), it will automatically power-on and enumerate the device as a Serial Communication Port. The COMx port can then be used to issue commands between the core board and the host PC. The power supply is regulated from 5V, provided via the micro-USB, to the nominal 3.3V for the PIC24 MCU.

14.2.2 Ethernet

Connecting a Ethernet cable to the RJ45 Mod Jack (J4) allows for TCP/IP communication between the LoRa Gateway Core board and LoRa network server. The TCP/IP Communication Protocol is handled by the ENC624J600. The Ethernet controller is connected with the microcontroller through a dedicated Serial Peripheral Interface (SPI).

14.3 INTERACTION, NAVIGATION, AND DISPLAY

The Gateway LCD is used to display start-up Splash Screen, Firmware Version, Configuration Settings, and Traffic Statistics Information. The top push button (S3) will clear all statistics information; restoring all values to zero. The middle push button (S2) alternates the LCD display between Version/Configuration display ([Figure 14-2](#)) and the Statistics Traffic values ([Figure 14-3](#)). The bottom push button (S1) is used as a hardware Reset.

Below are examples of the Gateway Display Screens:

LoRa[®] Technology Evaluation Suite User's Guide

FIGURE 14-1: SPLASH SCREEN

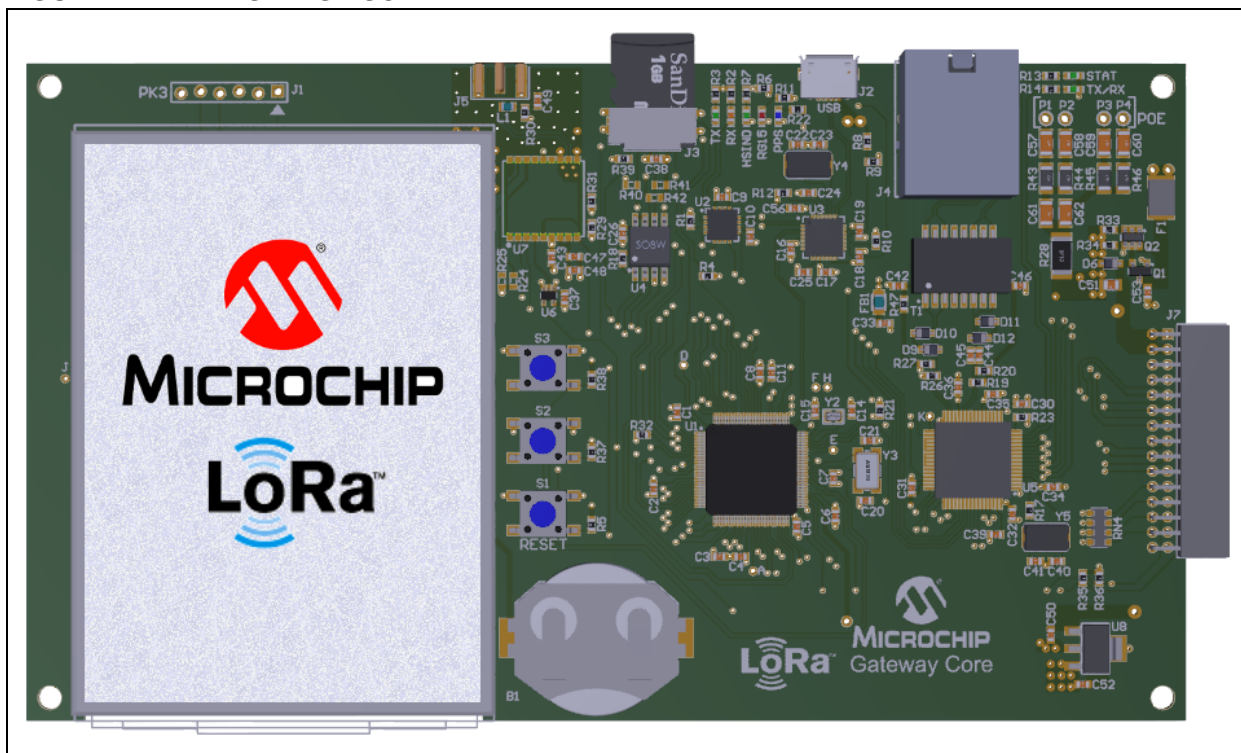
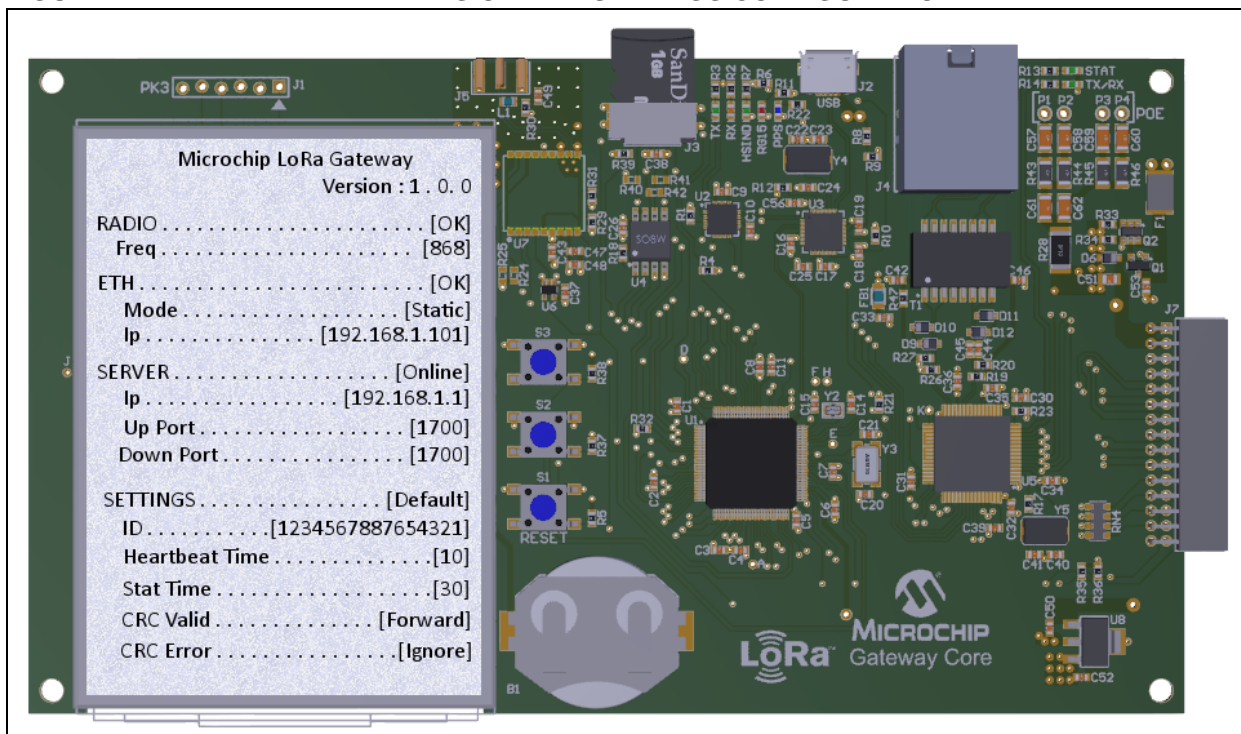
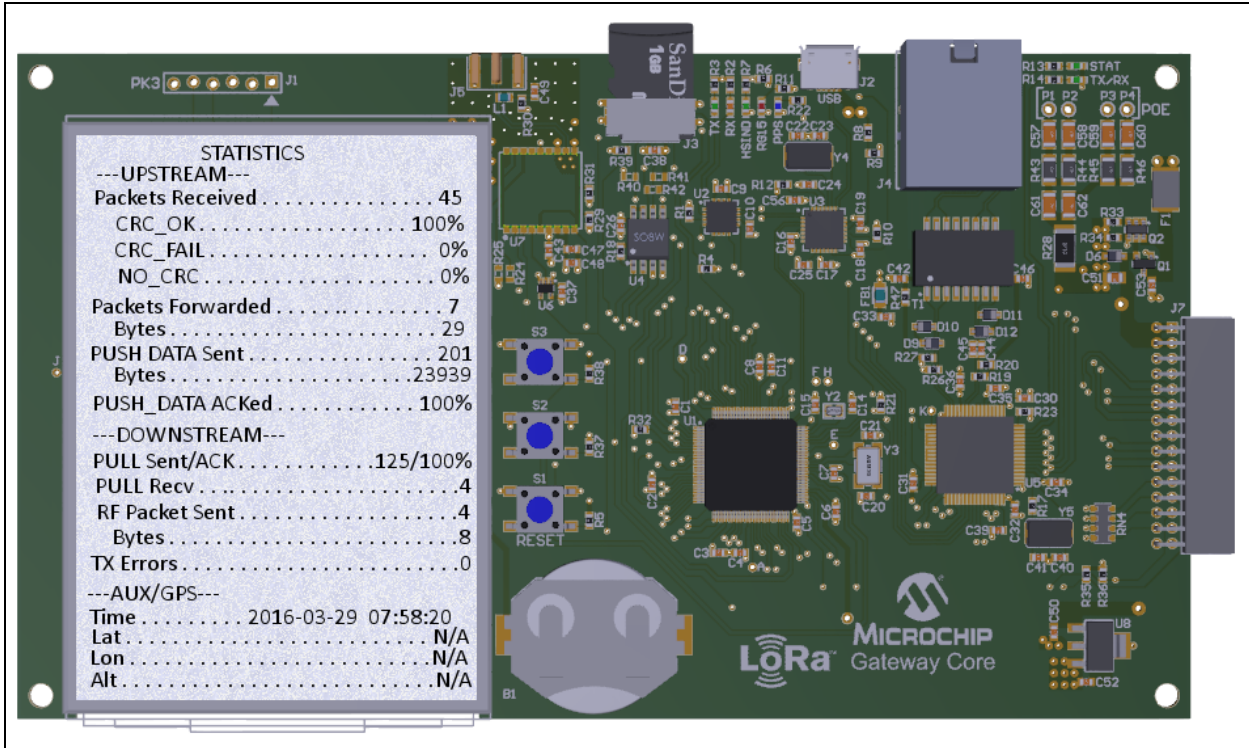

FIGURE 14-2: FIRMWARE VERSION AND SETTINGS CONFIGURATION



Gateway Behavior Operation

FIGURE 14-3: STATISTICS TRAFFIC



LoRa[®] Technology Evaluation Suite User's Guide

14.4 COMMANDS

LoRa Gateway Core board commands begin with the system keyword 'sys', and include the categories shown in [Table 14-1](#). The LoRa Gateway Core Board Communicates at a baud rate of 57,600.

TABLE 14-1: GATEWAY CORE BOARD COMMANDS

Command	Description
System Commands	
save	Save Current configurations to inserted microSD card
log	Configure the type of information output by the debug logger
ntp	Gateway used Network Time Protocol (NTP) IP Address
date	Gateway Configured NTP Data and Time Information
Get ONLY Commands	
ver	Request LoRa [®] Gateway Version Number
build	Request Build date on Firmware
report	Request Statistic Report Information
Get/Set Server Commands	
gwid	Request/Configure the LoRa Gateway Unique User ID (UUID)
ifmode	Request/Configure the Interface Mode the LoRa Gateway acquires its IP address
ifip	Request/Configure the Interface IP Address given to the LoRa Gateway board ⁽¹⁾
ifgw	Request/Configure the Interface IP Address for the Network Gateway (Router) ⁽¹⁾
ifmask	Request/Configure the Interface Network (Router) Subnet Mask ⁽¹⁾
svip	Request/Configure the LoRa Server IP Address the Gateway is using to packet forward
svup	Request/Configure the Server Port used for Up Link Communications
svdn	Request/Configure the Server Port used for Down Link Communications
heart	Request/Configure the current "Keep Alive Interval", time interval in seconds the Gateway sends a pull request to the Sever
stat	Request/Configure the timer interval in which LoRa Statistics are updated
sync	Request/Configure Sync Word used by the Gateway

Note 1: Only required in Static mode.

The response of 'invalid_param' will always be returned if the entered command is out of range. If the command send is not supported, a response will be returned indicating which element of the command was invalid.

For example:

Format: [cmd word 0]" "[cmd word 1]" "[cmd word 3]" "[Data; if applicable]

Incorrect Command: sys sat heart 10

Response: Invalid cmd word 1

Meaning: The second part of the command is incorrec.

More detailed descriptions of the LoRa Gateway Core board – commands, syntax, responses, descriptions, and format of parameter or variables affected can be found below:

Gateway Behavior Operation

System Commands

Save

Command: `sys save`

Responses: `OK` – The command was executed

`fail` – There was an error in execution

When received by the LoRa Gateway Core board, the Save command will attempt to read from the microSD card inserted, if the microSD card contains a valid 'config.json' file with server and Gateway information. If the file is successfully able to reconfigure the desired parameter, the response of "OK" will be returned. If the file is incorrectly formatted, or there is an issue accepting the file, the response of "fail" will be returned. For more detailed descriptions of the failure reason, the user can enable the CONFIG debug logger.

Example: `sys save`

`OK`

`// Save Successful`

Log

Default: `off`

Command: `sys log <logLevel>`

Responses: `ok`

`<logType>` string representing different log levels. Parameter values can be:

`off, error, warning, info, debug, verbose`

The Log command is used to configure the type of messages output by the Debug Logger on the Serial micro-USB connection. There are existing messages inside the LoRa Gateway firmware useful for evaluation system performance or debugging issues. Additionally, these tags can be used in expansion of the firmware for advanced users. Refer to LOG_XXXXXX implementations in code; e.g., LOG_DEBUG.

The default state is OFF; in this mode, the Core board will either update a parameter, or generate a response based upon the received command. Additionally, if a microSD card is inserted, the Save command can write current settings to ensure the proper retention of parameter values upon if a Reset or Power Cycle occurs; otherwise, default values will be restored.

When the logic level is not OFF, the Core board will print out appropriate message with prefix characters { [E], [W], [I], [D], [V] } to designate levels. Modes are incremental, so all lower level logs will also be printed. For example, if logLevel is set to Warning[logLevel2], error messages[logLevel1] will also be printed out.

Example: `sys log verbose`

`ok`

[E] Error message.....

[W] Warning message.....

[I] Info message.....

[D] Debug message.....

[V] Verbose message.....

LoRa[®] Technology Evaluation Suite User's Guide

NTP

Command: `sys ntp 128.138.141.172` [For Custom IPs]
`sys ntp` [Defaults IP to 128.138.141.172; University Of Colorado #2]

Responses: `ok`

Network Time Protocol (NTP) is used for clock synchronization between client and server used with packet-switched, variable-latency data networks. By default the Microchip Gateway will use the US based NTP supplied by the University of Colorado in Boulder at IP Address: 128.138.141.172.

Example: `sys ntp 212.59.0.2` [Europe.Pool.NTP.org; Lithuania Europe/Vilnius]

Date

Command: `sys date 2016-03-28T14:12:30Z`
`sys date` [Returns current Date/Time Settings]

Responses: `ok`

`2016-03-28T14:12:30Z`

Example: `sys date 1989-04-08T09:15:23Z` [System time set for April 8th, 1989 @ 9:15:23 am]

The data and timestamp information is provided from the NTP IP Address specified by the user. These values should be configured to reflect those of the NTP IP Address provided if values are not successfully fetched.

Get ONLY Commands

Version

Command: `sys get ver`
Responses: `Microchip LoRa Gateway Version X.Y.Z`

X – Major Revision

Y – Minor Update

Z – Patch/Errata Fixes

The version command is used to indicate the Gateway hardware type, and firmware which is being used. This will allow users and existing systems to understand Microchip Gateway features if/when different solutions become available.

Example: `sys get ver`
`Microchip LoRa Gateway Version 0.1.0` //Version number

Build

Command: `sys get build`
Responses: `Build on MM DD YYYY at HH:MM:SS`

M – Month

D – Day

Y – Year

H – Hour

M – Minute

S – Second

Gateway Behavior Operation

The build command is used to indicate the exact build timestamp for the currently running LoRa Gateway Firmware.

Example: `sys get build`
Build on Oct 7 2015 at 12:39:42 //Build information

Report

Command: `sys get report`

Responses: All values represented in the report are [16-bit value; 2-byte value] in size. Full Report response contains [17] descriptive statistics values.

Details of the statistics supplied are given in Figure 14-x, the expected report format is shown below:

[rxReceived] [rxOkRatio] [rxBadRatio] [rxNoCrc] [upPacketForward] [payloadByteSize] [pushByteSize] [pushDataSent] [pushAckRatio] [pullSent] [pullAckRatio] [pullDataRx] [pullByteSize] [pullPayload] [txOkCount] [txFailCount] [serverStatus].

TABLE 14-2: DESCRIPTION OF REPORT PARAMETERS RETURNED

Command	Description
rxReceived	Number of LoRa packets received by Gateway
rxOkRatio	Number of valid LoRa packets received; CRC Valid
rxBadRatio	Number of invalid LoRa Packets received; CRC error
rxNoCrc	Number of valid LoRa Packets received; No CRC
upPacketForward	Number of LoRa packets forwarded by Gateway to the server
payloadByteSize	Byte size of the last packet payload received
pushByteSize	Byte size of the packet being forwarded from Gateway to the server
pushDataSent	Data of the packet being forwarded from Gateway to the server
pushAckRatio	Ratio of the messages from the Gateway acknowledged by the server
pullSent	Number of pull requests issued by the Gateway to the server
pullAckRatio	Number of pull requests acknowledged by the server
pullDataRx	Last received data after a pull request was done by the Gateway
pullByteSize	Byte size of the last data received from pull requests
pullPayload	Data of the payload requested by the pull
txOkCount	Valid Number of successful transmissions done by the Gateway
txFailCount	Number of attempts where the Gateway failed to transmit
serverStatus	Current Status of Gateway to Server Communication

The Report command is used to get a full comprehensive report of the statistics information currently being maintained, monitored by the Gateway Core board. This command is specifically formatted to allow all information to be passed in a single string.

Example: `sys get report 10 15 5 15 10 20 42 15 20 15 42 10 9 11 12 3 1`
Server Status Results:

Out of Sync

-1 : Gateway and Server are communicating out of Sync

Timeout

0 : Gateway Fails to communication with Server

Connected

1 : Gateway and Server are communicating correctly

Get/Set Commands

Gateway Board ID

Default: 1234567887654321

Parameter: uint64_t config_lgwm

Command: sys get gwid

```
sys set gwid <gatewayID>
```

<value> 64 Bit; [8] Byte Hexadecimal value representing the Gateway ID

This command reads/configures the Gateway ID currently used by the development board. This ID is 64 bytes in length, and should be modified to ensure a UUID for the Gateway Core board within the user's LoRa network. This ID should exist for the life of the device on the network. If the Gateway is changing LoRa networks, its ID can be updated to ensure a UUID.

Example: sys set gwid FEDCBA987654321

```
ok
```

```
sys get gwid
```

```
0xFEDCBA987654321
```

```
//Gateway ID
```

Gateway Board IP Address

Default: 192.168.1.101

Parameter: uint32_t config_gw_if_ip_addr

Command: sys get ifip

```
sys set ifip <ipAddress>
```

<ipAddress> 32 Bit; [4] Byte Decimal value presented as the Gateway Board IP Address

This command reads/configures the LoRa Gateway development board's IP address. The IP address will be entered in the generic form, with Decimal for numeric values, and '.' between the values for separation. The command will be parsed and formatted into a Hexadecimal form for retention. When the IP address is requested, it will be presented in the standard format.

Example: sys set ifip 192.168.10.151

```
ok
```

```
sys get ifip
```

```
192.168.10.151
```

```
//Static IP Address
```

Network Gateway IP Address

Default: 192.168.1.1

Parameter: uint32_t config_gw_if_gateway

Command: sys get ifgw

```
sys set ifgw <net Address>
```

<netAddress> 32 Bit; [4] Byte Decimal value presented as the Network Gateway IP Address

Gateway Behavior Operation

This command reads/configures the Network Gateway being used by the LoRa Gateway Core board. This is typically a personal router or a network switch. The IP address can be entered in the generic form, with Decimal for numeric values, and '.' between the values for separation. The command will be parsed and formatted into a Hexadecimal form for retention. When the IP address is requested, it will be presented in the standard format.

```
Example: sys set iggw 192.168.1.5
        ok
        sys get ifgw
        192.168.1.5 //Static Network Gateway IP
```

Network Subnet Mask IP Address

Default: 255.255.255.0

Parameter: uint32_t config_gw_if_netmask

Command: sys get ifmsk

```
        sys set ifmsk <netMask>
```

<netMask> 32 Bit; [4] Byte Decimal value presented as the Network Subnet Mask IP Address

This command reads/configures the Network Subnet-Mask IP Address being used by the LoRa Gateway Core board. The Subnet Mask is used to divide an IP address into network and host addresses.

The Subnet Mask can be entered in the generic form, with Decimal for numeric values, and '.' between the values for separation. The command will be parsed and formatted into a Hexadecimal form for retention. When the IP address is requested, it will be presented in the standard format.

```
Example: sys set ifmsk 255.255.255.199
        ok
        sys get ifmsk
        255.255.255.199 //Static Network Subnet Mask IP
```

Server IP Address

Default: 192.168.1.100

Parameter: uint32_t config_server_ip

Command: sys get svip

```
        sys set svip <serverIP>
```

<serverIP> 32 Bit; [4] Byte Decimal value presented as the Server IP Address

This command reads/configures the Server IP Address to which the LoRa Gateway is forwarding LoRa packet information. The Server IP represents the location where the LoRa network server is currently being hosted. Once the LoRa packet has been received by the network server, the network will be responsible for determining to which application server the LoRa packet should be forwarded. The IP address can be entered in the generic form, with Decimal for numeric values, and '.' between the values for separation. The command will be parsed and formatted into a Hexadecimal form for retention. When the IP address is requested, it will be presented in the standard format.

LoRa[®] Technology Evaluation Suite User's Guide

```
Example: sys set svip 198.162.42.105
        ok
        sys get svip
        198.162.42.105                               //Server IP Address
```

Server Uplink Port Number

Default: 1700

Parameter: uint16_t config_server_up_port

```
Command: sys get svup
        sys set svup <upPort>
```

<upPort> 16 Bit; [2] Byte Decimal value presented as the Server Uplink Port Number

This command reads/configures the Server Uplink Port Number used by the network server for the TCP/IP communication. Based on this configuration, the server will communicate all Uplink actions to the specified port number.

```
Example: sys set svup 1780
        ok
        sys get svup
        1780                                         //Server Uplink Port Number
```

Server Downlink Port

Default: 1700

Parameter: uint16_t config_server_down_port

```
Command: sys get svdn
        sys set svdn <downPort>
```

<downPort> 16 Bit; [2] Byte Decimal value presented as the Server Downlink Port Number

This command reads/configures the Server Downlink Port Number used by the network server for the TCP/IP communication. Based on this configuration, the server will communicate all Uplink actions to the specified port number.

```
Example: sys set svdn 1782
        ok
        sys get svdn
        1782                                         //Server Downlink Port Number
```

Keep Alive Interval

Default: 10

Parameter: uint16_t config_keepalive

```
Command: sys get heart
        sys set heart <keepAlive>
```

<keepAlive> 16 Bit; [2] Byte Decimal value presented as length of time in seconds

Gateway Behavior Operation

This command reads/configures the Keep Alive Interval, or 'Heartbeat' of communication between the LoRa Gateway Core board and LoRa server. This represents the length of time between a 'Pull Request' being sent to the server. A pull request is sent to the server to maintain a constant connection; it allows the server to know that the Gateway in use is still active. It is the responsibility of the device to maintain connection with the server; otherwise the server will remove the device for resource management. The rate at which pull request must be received is determined by the server.

```
Example: sys set heart 30
        ok
        sys get heart
        30                                //Keep Alive Interval; Heartbeat
```

Statistics Printout Interval

Default: 30

Parameter: uint16_t config_stat_interval

Command: sys get heart

```
        sys set heart <statRate>
```

<statRate> 16 Bit; [2] Byte Decimal value presented as length of time in seconds

This command reads/configures the Statistics printout interval. This represents the length of time between the Statistics being output to the Debug Logger. Statistics is part of the [I]nfo type, so the `sys log info` command is required to be displayed.

```
Example: sys set stat 60
        ok
        sys get stat
        60                                //Statistics Printout Rate
```

SYNC

Default: 0x34

Parameter: uint8_t config_gw_sync_word

Command: sys get sync

```
        sys set sync <syncWord>
```

<syncWord> 8-bit; [1] Byte Hex Value representing the valid used SyncWord

This command reads/configures the LoRa Gateway Core board valid SyncWord used during LoRa communication. By default, the SyncWord is configured to 0x34, which typically represents a public network; while a value of 0x12 represents a private network. It is possible to use other values for the SyncWord; however, at this time only the public/private values have been defined.

```
Example: sys set sync 12
        ok
        sys get sync
        12                                //Currently used Gateway SyncWord
```

14.5 GENERAL APPLICATION DESCRIPTION

The LoRa Gateway Radio board captures all LoRa uplink packets using the two on-board SX1257 Semtech transceivers, and concentrates them into the SX1301 Base Band Processor. The SX1257 transceiver is capable of operating on (4) channels, while the SX1301 is capable of concentration up to (2) SX transceiver captured information. This gives the Radio board the capability of operating on up to (8) LoRa Channels at one time. GPIO status LEDs populated on the Radio are controlled by the SX1301 and are used to indicate behavior. The 5V micro-USB B connector can be used to supply direct power to the Radio board, but is unnecessary when connected with the Gateway Core board. In rare cases it is sometimes necessary to power both Radio and Core board via the USB-B cable if insufficient current is supplied by the source; e.g., external USB HUBs.

The LoRa Gateway Core board receives data information from the SX1301 which was captured by the Radio board. The Core board's on-board PIC24 is then responsible for converting the information into a TCP/IP ready packet structure using an on-board Ethernet encounter device. This Ethernet communication allows exchange of information between LoRa Gateway and connected LoRa Network Server. Basic commands are issued through the micro-USB connector for configuration of Gateway parameters; Refer to [Section 14.6 "Gateway Configuration"](#). Additionally, board configuration settings can be stored and loaded from a microSD card; Refer to [Section 14.7 "SD Card Configuration"](#).

Below are images showing the communication paths of the Gateway during Receive and Transmit processing ([Figure 14-4](#), and [Figure 14-5](#)):

FIGURE 14-4: GATEWAY RECEIVE PATH

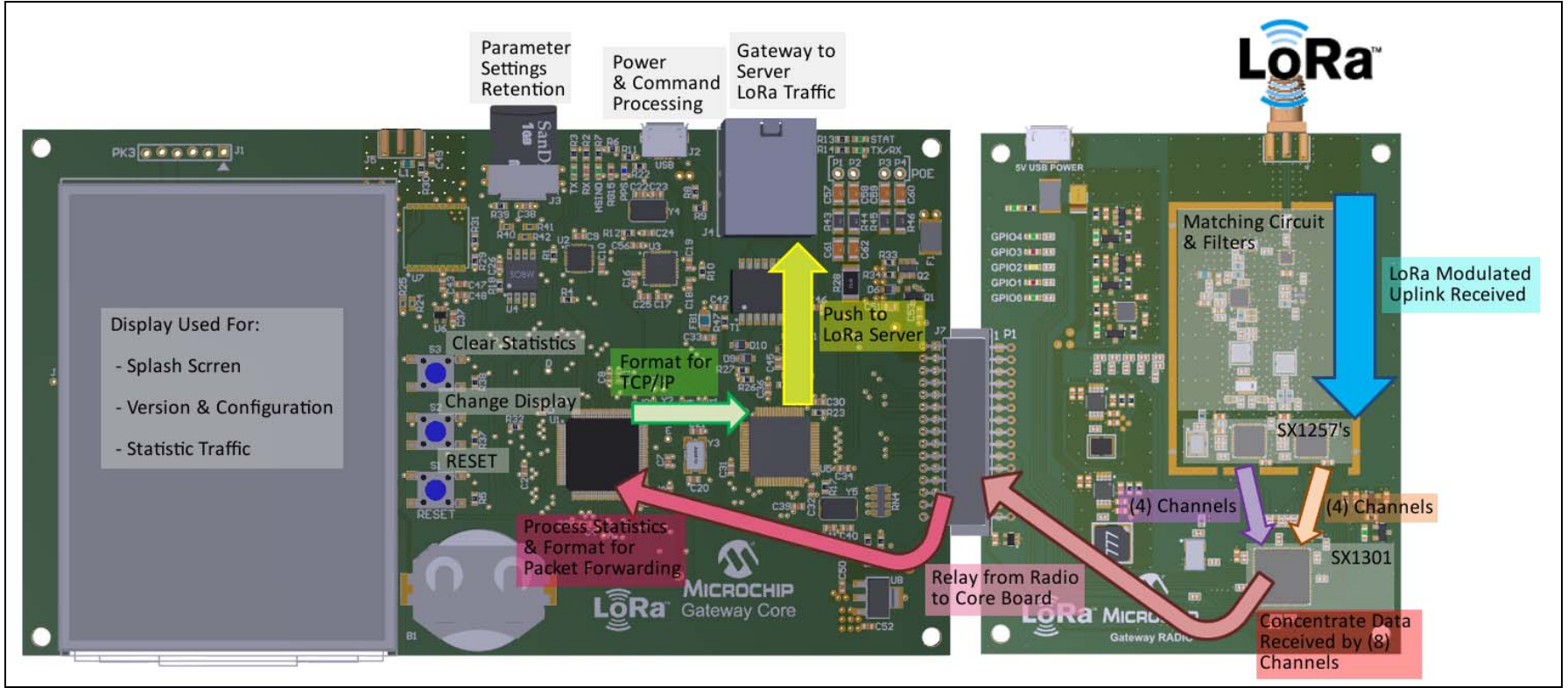
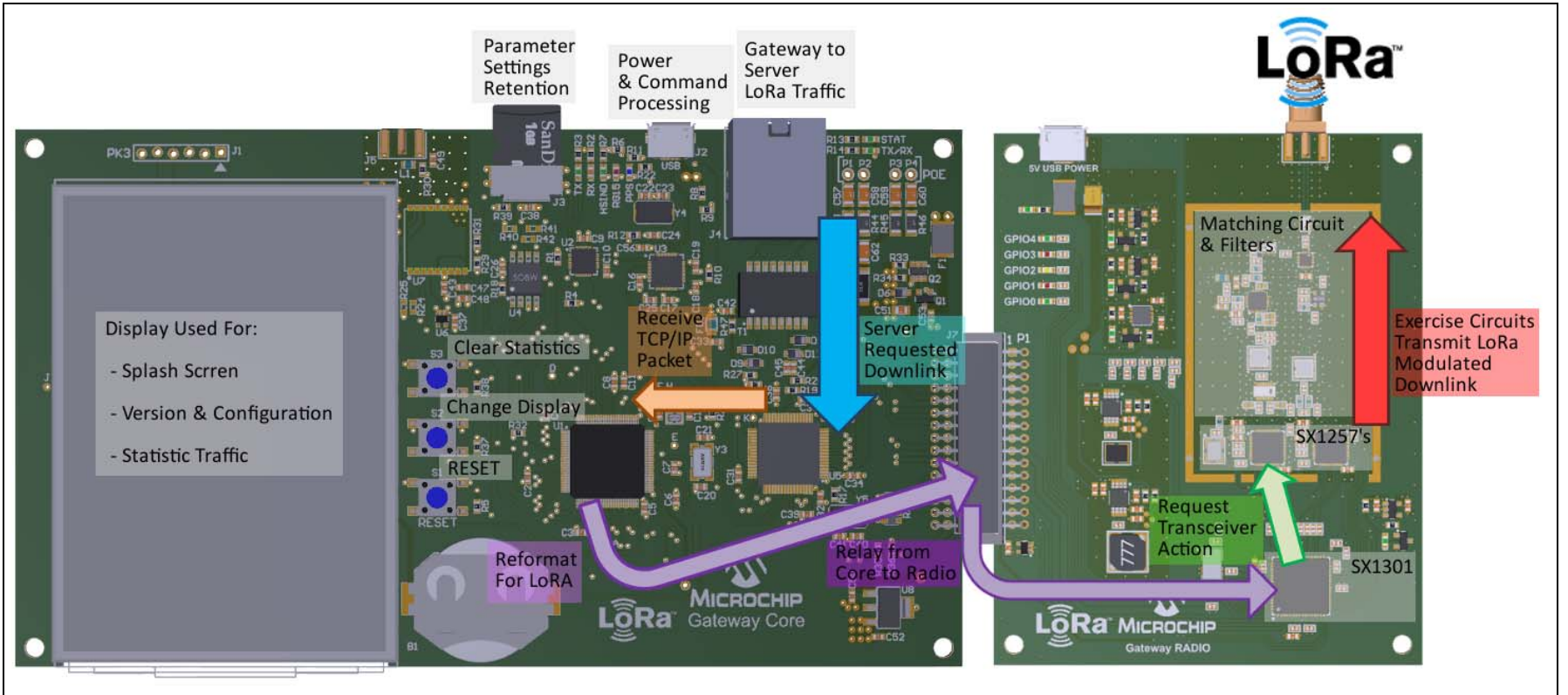

FIGURE 14-5: GATEWAY TRANSMIT PATH



14.6 GATEWAY CONFIGURATION

The LoRa Gateway Core board requires minor configurations prior to implementation; this setup is required to establish communication with the desired LoRa server. The descriptions of parameters, along with the command syntax can be found in [Section 14.4 “Commands”](#).

- Gateway ID
- Gateway Method
- Gateway IP Address
- Gateway Network
- Default Subnet Mask
- Server IP
- Server Up Port
- Server Down Port
- Keep Alive Interval
- Stat Interval
- Network Time Protocol (NTP) IP Address
- NTP Date and Time

The LoRa Gateway Core can be configured in three ways, as described below:

- Connecting a micro-USB (J2) to the Gateway board, launch the LoRa Development Utility, select the Gateway from the Device List. Configure using the visual interface as described in [Chapter 13. “Gateways”](#).
- Connecting a micro-USB (J2) to the Gateway board allows the user to configure the board by issuing serial commands at the baud rate of 57,600 (refer to [Section 14.4 “Commands”](#))
- If a microSD card (J3) is detected upon Reset/Power-on, the Gateway board will automatically read and configure it accordingly. Please refer to [Section 14.7 “SD Card Configuration”](#) for the configuration file, creation, description and example

14.7 SD CARD CONFIGURATION

Upon Power-on Reset, the LoRa Gateway Core board will attempt a read of the microSD card, if present. The configuration script should be saved in a JSON format, and must be the only file on the microSD.

The Script can be written in Notepad, Notepad++, or any basic text editor. It is required that the script be saved with a .json definition. Below is an example script which can be used for microSD card boot-up configuration.

EXAMPLE 14-1: SD CARD CONFIGURATION EXAMPLE

```
# Config file for Microchip LoRa Gateway
# All comments starts with # and will be ignored
# Config string should be a SINGLE-LINE json string
# The following fields can be configured:
# gateway_id: 16 Bytes /* gateway uuid */
# gw_if_mode:{"dhcp"|"static"}/* gateway eth interface mode */
# gw_if_ip_addr: 4 Bytes /* LoRa gateway board Ip address, needef if
gw_if_mode=="static", ignored otherwise */
# gw_if_gateway: 4 Bytes /* Network gateway (router) Ip address, needef if
gw_if_mode=="static", ignored otherwise */
# gw_if_netmask: 4 Bytes/* Network subnet mask, needef if gw_if_mode=="static",
ignored otherwise */
# server_ip: 4 Bytes /* server ip address */
# server_up_port: 0-65535 /* server port for up link communication
*/
# server_down_port: 0-65535 /* server port for down link communication
*/
# keepalive_interval: 0-65535 /* keep alive interval, pull request send to
server every keepalive_interval seconds */
# stat_interval:0-65535 /* statistics interval, LoRa statistics update, in seconds
*/
# sync_word: 1 Byte /* LoRa network Sync Word, 0x12:Private, 0x34:Public */
#
# Below is the actual setup
#
{"gateway_id":"AABBCCDD00112233","gw_if_mode":"dhcp","gw_if_ip_addr","192.168.1.99",
"gw_if_gateway":"192.168.1.100","gw_if_netmask":"255.255.255.0"
,"server_ip":"192.168.0.101","server_up_port":1700,"server_down_port":1700,"keepalive
_interval":10,"stat_interval":30,"push_timeout_ms":100,"sync_word":34}
```

In this example, the parameters were configured as follows:

Gateway ID: AABBCCDD00112233

Interface Mode: dhcp

Board IP Address: 192.168.1.99

Router IP Address: 192.168.1.100

Subnet Mask: 255.255.255.0

Server IP: 192.168.0.101

Server Up Port: 1700

Server Down Port: 1700

Keep Alive Interval: 10

Statistic Interval: 30

Push Time out: 100

Sync Word: 34

14.8 BOOTLOADER AND FIRMWARE UPDATES

The Gateway Application Firmware is preprogrammed with the supporting EZBL (Easy Bootloader) application. The EZBL works through use of a console command interface, and uses files stored in Blobber (.blob) format for Firmware Updates.

Additionally, the Gateway Application can be updated through the traditional ICSP™ programming method using .Hex formatted files. ICSP firmware updates require one of Microchip's available programmer tools such as: PICKit 3, ICD 3, REAL ICE™; etc. It is highly recommended to only reprogram the Microchip Gateway board with officially supported firmware updates.

Application Firmware updates can be booted to the Gateway board through the use of the console command line interface. The user is capable of browsing, and selecting the `ezbl_tools.jar` Java executable. Through interaction with the Java executable, the user can select the latest distributed .blob file and request a bootloader process to be launched.

The latest version of the EZBL .JAR application can be found at: www.microchip.com/ezbl.

The latest available copy of the LoRa Gateway Application Firmware will be available in either Hex or Blob format at: www.microchip.com/lora.

For the purpose of this example, the EZBL has been downloaded and unpackaged to a folder named: "MicrochipGateway" located on the Desktop. However, the user can save the EZBL and files at any desired directory location.

For this example, the Gateway enumerated on COM67. Refer to system Device Manager for COM Port enumeration details.

Below is an example of this process:

1. Browse to the Easy Bootloader folder within the Gateway project.

FIGURE 14-6: BROWSING BY COMMAND LINE

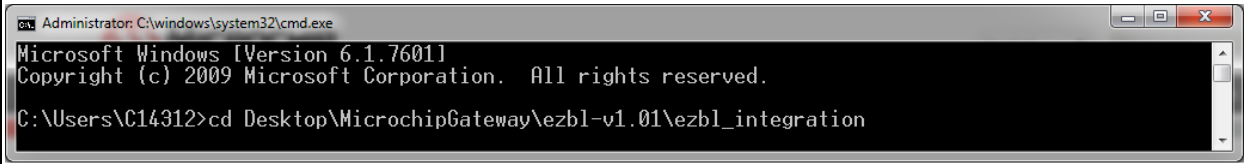

```
Administrator: C:\windows\system32\cmd.exe
Microsoft Windows [Version 6.1.7601]
Copyright (c) 2009 Microsoft Corporation. All rights reserved.

C:\Users\C14312>cd Desktop\MicrochipGateway\ezbl-v1.01\ezbl_integration
```

2. Write the following command line to launch the .jar, and apply the select generated .blob file:

- `java -jar ezbl_tool.jar -communicator -com=\\.\\.\\[COM PORT] -baud=115200 -timeout=3000 -artifact="[Blob Dir]"`

FIGURE 14-7: BLOB FILE SELECTION

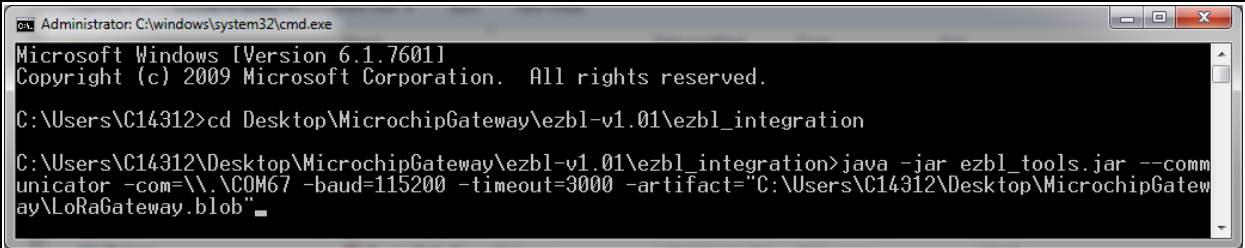

```
Administrator: C:\windows\system32\cmd.exe
Microsoft Windows [Version 6.1.7601]
Copyright (c) 2009 Microsoft Corporation. All rights reserved.

C:\Users\C14312>cd Desktop\MicrochipGateway\ezbl-v1.01\ezbl_integration

C:\Users\C14312\Desktop\MicrochipGateway\ezbl-v1.01\ezbl_integration>java -jar ezbl_tools.jar --communicator -com=\\.\\.COM67 -baud=115200 -timeout=3000 -artifact="C:\Users\C14312\Desktop\MicrochipGateway\LoRaGateway.blob"
```

LoRa[®] Technology Evaluation Suite User's Guide

3. Press enter to execute the `.jar` and allow update. It is required to press the **Reset** button on the Gateway board within the three seconds (time-out) period. Afterwards, the console will indicate the progress.

FIGURE 14-8: BOOTLOAD EXECUTION

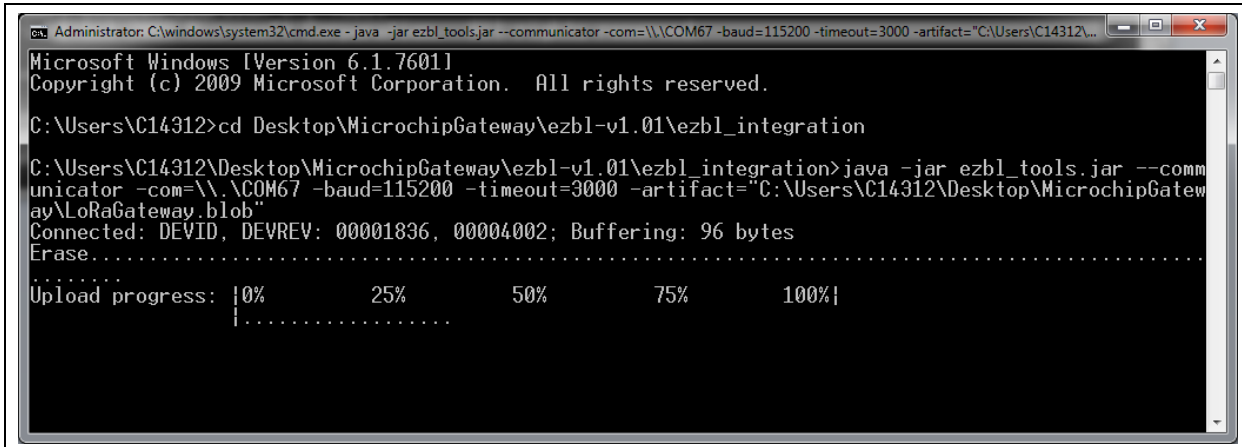

```
Administrator: C:\windows\system32\cmd.exe - java -jar ezbl_tools.jar --communicator -com=\\.\COM67 -baud=115200 -timeout=3000 -artifact="C:\Users\C14312\...
Microsoft Windows [Version 6.1.7601]
Copyright (c) 2009 Microsoft Corporation. All rights reserved.

C:\Users\C14312>cd Desktop\MicrochipGateway\ezbl-v1.01\ezbl_integration

C:\Users\C14312\Desktop\MicrochipGateway\ezbl-v1.01\ezbl_integration>java -jar ezbl_tools.jar --communicator -com=\\.\COM67 -baud=115200 -timeout=3000 -artifact="C:\Users\C14312\Desktop\MicrochipGateway\LoRaGateway.blob"
Connected: DEVID, DEVREV: 00001836, 00004002; Buffering: 96 bytes
Erase.....
Upload progress: |0%          25%          50%          75%          100%|
                  |.....|
```

4. Once indicated the project has been updated, the console will show how many bytes were sent, and at what rate. After the application code has been flashed, the Gateway board will automatically restart.

FIGURE 14-9: COMMAND LINE BOOTLOADING SUCCESS

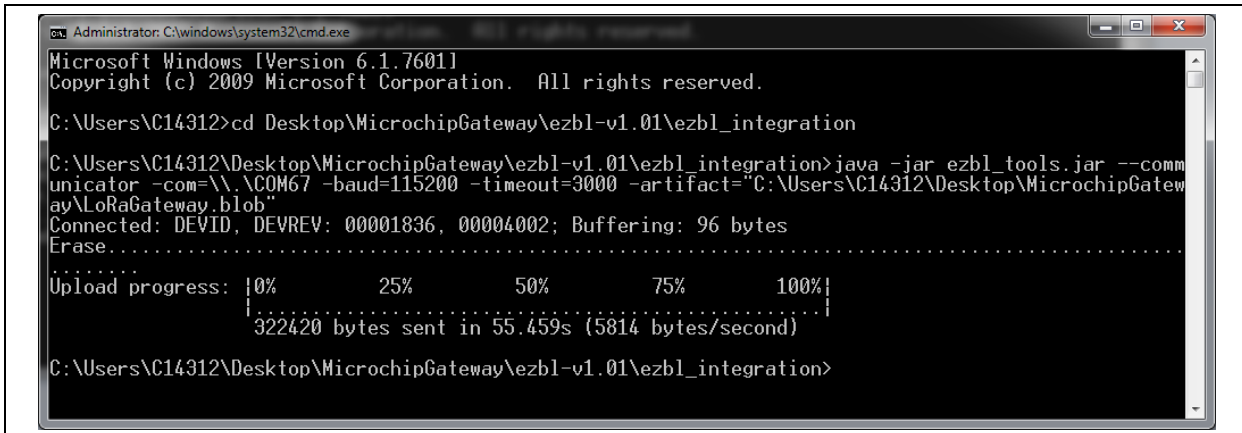

```
Administrator: C:\windows\system32\cmd.exe
Microsoft Windows [Version 6.1.7601]
Copyright (c) 2009 Microsoft Corporation. All rights reserved.

C:\Users\C14312>cd Desktop\MicrochipGateway\ezbl-v1.01\ezbl_integration

C:\Users\C14312\Desktop\MicrochipGateway\ezbl-v1.01\ezbl_integration>java -jar ezbl_tools.jar --communicator -com=\\.\COM67 -baud=115200 -timeout=3000 -artifact="C:\Users\C14312\Desktop\MicrochipGateway\LoRaGateway.blob"
Connected: DEVID, DEVREV: 00001836, 00004002; Buffering: 96 bytes
Erase.....
Upload progress: |0%          25%          50%          75%          100%|
                  |.....|
                  322420 bytes sent in 55.459s (5814 bytes/second)

C:\Users\C14312\Desktop\MicrochipGateway\ezbl-v1.01\ezbl_integration>
```

5. Process is completed.

FIGURE 14-10: COMMAND LINE BOOTLOADING FAILURE

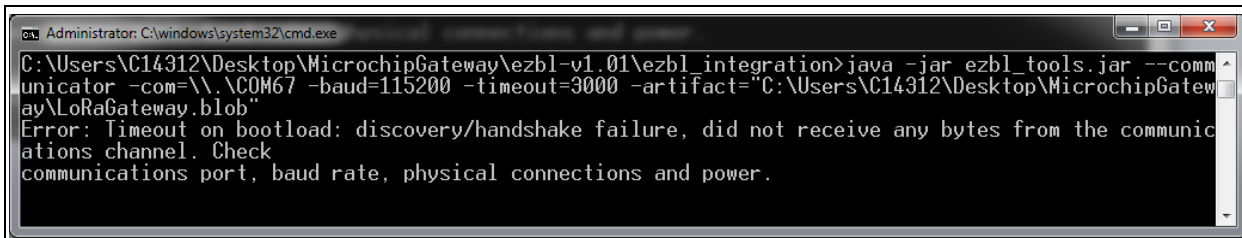

```
Administrator: C:\windows\system32\cmd.exe
C:\Users\C14312\Desktop\MicrochipGateway\ezbl-v1.01\ezbl_integration>java -jar ezbl_tools.jar --communicator -com=\\.\COM67 -baud=115200 -timeout=3000 -artifact="C:\Users\C14312\Desktop\MicrochipGateway\LoRaGateway.blob"
Error: Timeout on bootload: discovery/handshake failure, did not receive any bytes from the communications channel. Check communications port, baud rate, physical connections and power.
```

Note: If the bootloader fails to establish communication with the Gateway board, or if the time-out overlaps prior to pressing the **Reset** button, the command console will indicate the failure condition.

NOTES:

LoRa[®] Technology Evaluation Suite User's Guide

Chapter 15. LoRa[®] Technology Server and Database

15.1 OVERVIEW

Through use of the LoRa Development Utility it is possible to interact and manage the MySQL databases used along with the example LoRa servers. This allows users that have a good understanding of the LoRa system to configure and evaluate the technology without any knowledge of the SQL and JSON commands. Additionally, the MySQL database tables are drawn and displayed within the model view to allow for easier, more concentrated use.

15.2 FEATURES

The Server model view is divided into two tab panes, for a more comprehensive display and navigation layout. The **Server** tab pane contains multiple titled panels that may be collapsed when no longer needed to improve visual presentation. While the **Database** tab pane contains dynamically resizable table columns to conform to desired viewing size. The GUI is only capable of running a single instance of the Server Device Model, and the capability of MySQL communication is required for use.

Below are the available tabs for the Server model:

- Server
- Database

15.3 DESCRIPTION

The Server can be added to the Device List through use of the menu at the top of the LoRa Development Utility. Once added, the Server must be removed prior to the Add option to again be available. Once the Server is selected from the Device List, a MySQL command is sent to fetch any AppEUI values which are maintained by a Local Host Database. If no database exists, or MySQL communication fails, the **AppEUI** combo box under **Non-Provisioned (OTAA) Devices** will remain unpopulated. Once MySQL communication is restored, the combo box will be populated upon selection, or navigation back to **Server** tab from **Database**.

The **Database** tab is populated with appropriate tables, as stored in the LoRa database. These tables are refreshed upon **Table View** selection, navigation into **Database** from **Server** tab, or at the rate specified by the **Polling Rate**.

15.3.1 Server Tab Description

Below are the interactive elements of the tab for the Server Device Model, as represented in [Figure 15-1](#):

1. Server/Database Operation
2. Server Hosting Type
3. Network Hosted pane
4. MySQL IP Address
5. Update MySQL IP
6. Local Hosted pane
7. Server Status Indicators
8. Local LoRa Server IP display
9. Local Server port number
10. Launch Local Server
11. Application Server Setup pane
12. Application Extended-Unique-Identifier (AppEUI)
13. Application Server Name
14. Application Server Owner
15. Create/Update Application Server to Database
16. End-Device Actions
17. Insert/Update Provisioned (ABP) device
18. Device Address (DevAddr)
19. Network Session Key (NwkSKey)
20. Application Session Key (AppSKey)
21. Insert/Update Device in database
22. Insert/Update Non-Provisioned (OTAA) device
23. Application Server Extended-Unique-Identifier (AppEUI)
24. Application Key (AppKey)
25. Device Extended-Unique-Identifier (DevEUI)
26. Insert/Update Device in database
27. Queue End-Device Downlink
28. Device Address (DevAddr)
29. Downlink Port Number
30. Downlink Payload
31. Queue Downlink Message

FIGURE 15-1: SERVER TAB LAYOUT

The screenshot displays the 'Server' tab layout, which is organized into several sections:

- 1** Server/Database Operation: A dropdown menu.
- 2** Database Connection: Contains a text input for 'MySQL IP Address' (value: 192.168.1.1) and a 'Connect to IP' button.
- 3** MySQL IP Address: The text input field.
- 4** Connect to IP: The button.
- 5** Servers Version: A section header.
- 6** Network Server: R2.1.1
- 7** Application Server: R2.1.1
- 8** Customer Server: R2.1.1
- 7** Server Application: A section header.
- 8** Application Extended-Unique-Id (AppEUI): Text input field.
- 9** Server Application Name: Text input field.
- 10** Server Application Owner: Text input field.
- 11** Insert/Update in Database: Button.
- 12** End Device Actions: A section header.
- 13** Provisioned (ABP): A section header.
- 14** Device Address: (DevAddr): Text input field.
- 15** Network Session Key (NwkSKey): Text input field.
- 16** Application Session Key (AppSKey): Text input field.
- 17** Insert/Update in Database: Button.
- 18** Non-provisioned (OTAA): A section header.
- 19** Server Application EUI: Select EUI dropdown menu.
- 20** Application Key (AppKey): Text input field.
- 21** Device Extended-Unique-Id (DevEUI): Text input field.
- 22** Insert/Update in Database: Button.
- 23** Queue End Device Downlink: A section header.
- 24** Device Address (DevAddr): Text input field.
- 25** Downlink Port #: Text input field.
- 26** Payload Message: Text input field.
- 27** Queue Downlink Message: Button.

Server/Database Operation

FIGURE 15-2: SERVER/DATABASE OPERATION TITLED PANE

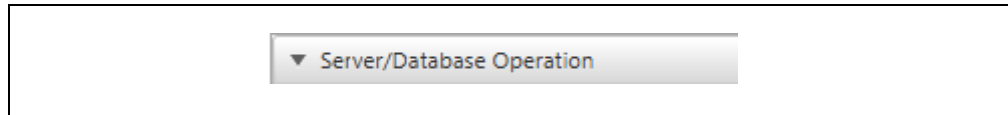

Description

Collapsible titled pane (Figure 15-2), used to determine the method of Server and Database interaction.

Execution conditions

- Left click on field

Database Connection

FIGURE 15-3: DATABASE CONNECTION TITLED PANE

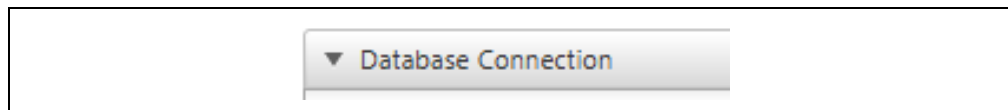

Description

Collapsible titled pane (Figure 15-3) used to configure the LoRa Database MySQL IP Address.

Execution conditions

- Left click on field

MySQL IP Address

FIGURE 15-4: MySQL IP ADDRESS VALIDATOR



Description

This text field is used to specify the IP Address where the MySQL database is currently being hosted (Figure 15-4). Access to the MySQL database is necessary to perform Insert/Update actions, as well as to view the tables created under the **Database** tab.

Valid Range

- 0.0.0.0 – 255.255.255.255

Execution conditions

- Model updated upon **Enter** key press in field
- Model updated upon **Update MySQL IP** push button press

Connect to MySQL IP

FIGURE 15-5: CONNECT TO IP PUSH BUTTON



Description

This push button is used to issue the change of the MySQL Address stored within the server data model (Figure 15-5). Without a functional MySQL IP Address, the LoRa Utility will be unable to execute database commands. Typically, the message “Cannot connect to MySQL” will be displayed if the entered IP is invalid.

Execution conditions

- MySQL command issued on press

Server Version

FIGURE 15-6: SERVER VERSION TITLED PANE

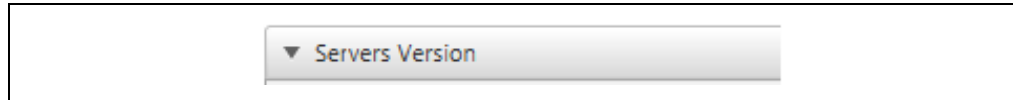

Description

Collapsible titled pane (Figure 15-6) used to display LoRa Evaluation Server Version information captured from the MySQL database.

Execution conditions

- Left click on field

Server Version Labels

FIGURE 15-7: SERVER VERSION LABELS

Network Server: Not Connected	Network Server: R2.1.1
Application Server: Not Connected	Application Server: R2.1.1
Customer Server: Not Connected	Customer Server: R2.1.1

Description

Labels populated inside the Server Version Titled pane used to visually indicate the currently connect LoRa Evaluation Server/Data base version information (Figure 15-7).

Execution conditions

- These Labels are updated automatically upon a valid MySQL connection through the Utility

Server Application Pane

FIGURE 15-8: SERVER APPLICATION TITLED PANE

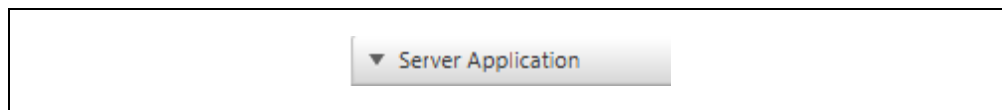

Description

Collapsible titled pane (Figure 15-8) used for creation, or modification of an Application Server.

Execution conditions

- Left click on field

Application Extended-Unique-Identifier (AppEUI)

FIGURE 15-9: AppEUI TEXT FIELD



Description

This text field is used to specify the Application Extended-Unique-Identifier (AppEUI) which will be assigned for the Application Server Instance being created (Figure 15-9). The AppEUI must be unique to the Network Server.

Valid Range

- 0x0 - 0xFFFFFFFFFFFFFFFF

Execution conditions

- Issued on **Insert/Update Server Application to Database** button press

Server Application Name

FIGURE 15-10: SERVER APPLICATION NAME TEXT FIELD

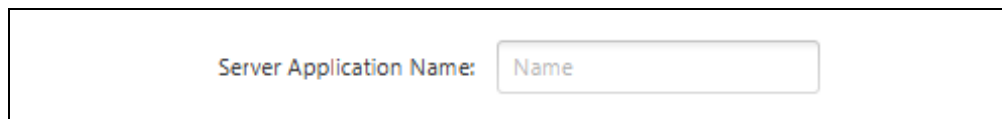

Description

This text field is used to specify the Server Name which will be attached to the Application Server as indicated by the Application Extended-Unique-Identifier field (Figure 15-10). If the AppEUI already exist as a server, the Server Name will be updated with the new specified name.

Valid Input

- Valid String

Execution conditions

- Issued on **Create/Update Application Server to Database** button press

Server Application Owner

FIGURE 15-11: SERVER APPLICATION OWNER TEXT FIELD

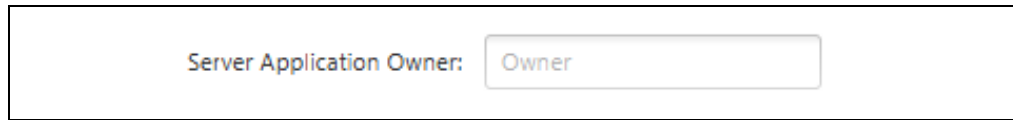

Server Application Owner:

Description

This text field is used to specify the Server Owner which will be attached to the Application Server as indicated by the Application Extended-Unique-Identifier field (Figure 15-11). If the AppEUI already exists as a server, the Server Owner will be updated with the new specified owner.

Valid Input

- Valid String

Execution conditions

- Issued on **Insert/Update Server Application to Database** button press

Insert/Update Server Application to Database

FIGURE 15-12: INSERT/UPDATE SERVER APPLICATION TO DATABASE PUSH BUTTON

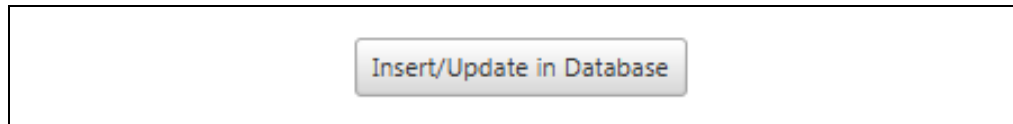

Description

This push button is used to issue the MySQL command to **Insert/Update** a row in the Application Servers Database table (Figure 15-12). Required parameters are parsed from the fields under the **Server Application Setup** titled pane.

Execution conditions

- MySQL command issued on press

Effects Databases

- lora_application, lora_network, lora_customer

MySQL Command

For → All Databases

- `INSERT INTO applications VALUES ('AppEUI', 'ServerName', 'ServerOwner')`
- `UPDATE applications SET name = 'ServerName', owner = 'ServerOwner'`
`WHERE eui = 'AppEUI'`

End Device Actions

FIGURE 15-13: END DEVICE ACTIONS TITLED PANE

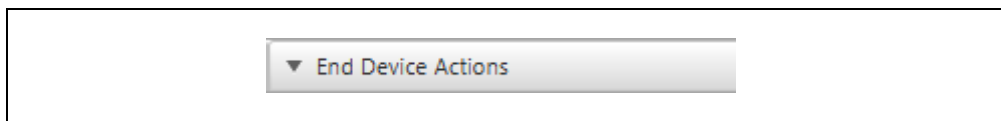

Description

Collapsible titled pane (Figure 15-13) used to add valid end devices to the Server/Database, or used to queue a Downlink Message for response to a valid End Device.

Execution conditions

- Left click on field

Insert/Update Provisioned (APB) device

FIGURE 15-14: APB DEVICE TITLED PANE

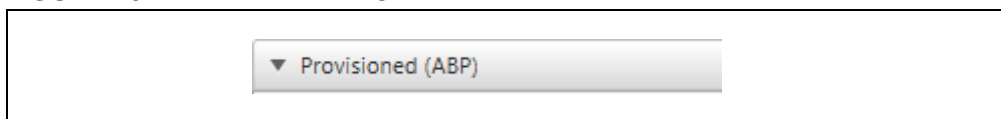

Description

Collapsible titled pane (Figure 15-14) used to insert or update a SQL database with applicable Provisioned (ABP) Device authentication information.

Execution conditions

- Left click on field

Device Address (DevAddr)

FIGURE 15-15: DEVICE ADDRESS TEXT FIELD

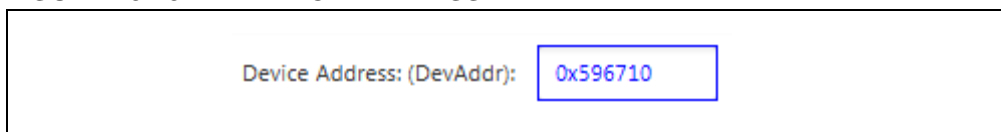

Description

This text field is used to specify the Device Address (DevAddr) for the Provisioned device requesting an **Insert/Update** action to the MySQL database (Figure 15-15). The Device Address must be unique to the LoRaWAN network it is joining.

Valid Range

- 0x0 - 0xFFFFFFFF

Execution conditions

- Issued on **Insert/Update Provisioned Device to Database** button press

Network Session Key (NwkSKey)

FIGURE 15-16: NwkSKey TEXT FIELD

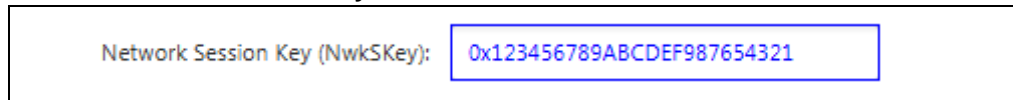

Network Session Key (NwkSKey):

Description

This text field is used to specify the Network Session Key (NwkSKey) used along with the specified Device Address (Figure 15-16). The Network Session Key is generated and maintained by the Application Server. It is used to grant the end-device authentication access to the LoRa Network Server.

Valid Range

- 0x0 - 0xFFFFFFFFFFFFFFFFFFFFFFFFFFFFFFFF

Execution conditions

- Issued on **Insert/Update Provisioned Device to Database** button press

Application Session Key (AppSKey)

FIGURE 15-17: AppSKey TEXT FIELD

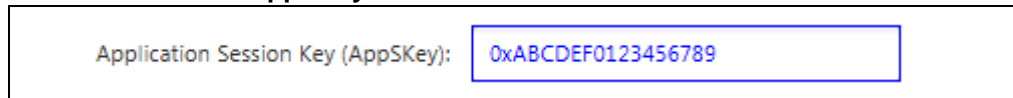

Application Session Key (AppSKey):

Description

This text field is used to specify the Application Session Key (NwkSKey) used along with the specified Device Address (Figure 15-17). The Application Session Key is generated and maintained by the Application Server. It is used to grant the end-device authentication access to the LoRa Application Server.

Valid Range

- 0x0 - 0xFFFFFFFFFFFFFFFFFFFFFFFFFFFFFFFF

Execution conditions

- Issued on **Insert/Update Provisioned Device to Database** button press

Insert/Update Provisioned Device to Database

FIGURE 15-18: ADD DEVICE TO DATABASE PUSH BUTTON

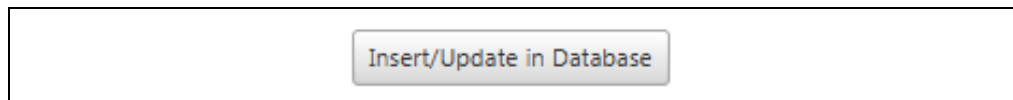

Description

This push button is used to issue the MySQL command to Insert/Update a row in the ABP Devices Database table (Figure 15-18). Required parameters are parsed from the fields under the **Insert/Update Provisioned (ABP) Device** titled pane.

Execution conditions

- MySQL command issued on press

Effects Databases

- lora_application, lora_network

MySQL Command

For → lora_application

- INSERT INTO 'activemotes' ('eui', 'appEui', 'sessionKey', 'networkAddress') VALUES ('DevAddr', '0', 'AppSKey', 'DevAddr')
- UPDATE activemotes SET eui = 'DevAddr', appEUI = '0', sessionKey = 'AppSKey', WHERE networkAddress = 'DevAddr'

For → lora_network

- INSERT INTO 'motes' ('eui', 'appEui', 'networkSessionKey', 'networkAddress') VALUES ('DevAddr', '0', 'NwkSKey', 'DevAddr')
- UPDATE motes SET eui = 'DevAddr', appEUI = '0', networkSessionKey = 'NwkSKey', downMsgSeqNo = '0', upMsgSeqNo = '0', WHERE networkAddress = 'DevAddr'

Insert/Update Non-Provisioned (OTAA) device

FIGURE 15-19: OTAA TITLED PANE

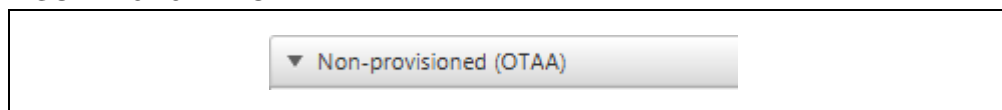

Description

Collapsible titled pane (Figure 15-19) used to insert or update a SQL database with applicable Non-Provisioned (OTAA) Device authentication information.

Execution conditions

- Left click on field

Application Server Extended-Unique-Identifier (AppEUI)

FIGURE 15-20: AppEUI COMBO BOX



Description

This combo box is used to select the desired Server Application (AppEUI) to which the end device, through Non-Provisioned joining method will operate (Figure 15-20). This combo box is automatically populated with available Server Applications based upon the MySQL database tables. Therefore, only previously added Server Applications are available for selection from the combo box when attempting to add authentication credentials/information.

Valid Range

- 0x0 - 0xFFFFFFFFFFFFFFFF

Execution conditions

- Issued on **Insert/Update Non-Provisioned Device to Database** button press

Application Key (AppKey)

FIGURE 15-21: AppKey TEXT FIELD

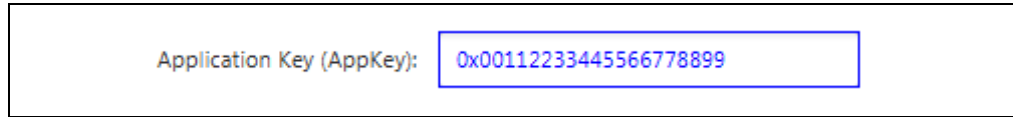

A screenshot of a text input field. The label "Application Key (AppKey):" is on the left. The input field contains the hexadecimal value "0x00112233445566778899".

Description

This text field is used to specify the Application Key (AppKey) attached to the Device Extended-Unique-Identifier that allows access to a specified Application Server (Figure 15-21). The Application Key is created by the server, and is used for initial authentication. Once Non-Provisioned devices successfully join the network, additional authentication keys will be granted to the device, and transmitted to the device during the LoRaWAN joining process.

Valid Range

- 0x0 - 0xFFFFFFFFFFFFFFFFFFFFFFFFFFFFFFFF

Execution conditions

- Issued on **Insert/Update Non-Provisioned Device to Database** button press

Device Extended-Unique-Identifier (DevEUI)

FIGURE 15-22: DevEUI TEXT FIELD



A screenshot of a text input field. The label "Device Extended-Unique-Id (DevEUI):" is on the left. The input field is empty.

Description

This text field is used to specify the Device Extended-Unique-Identifier wanting to join the specified Application Server (Figure 15-22). This DevEUI must be unique within the Network.

Valid Range

- 0x0 - 0xFFFFFFFFFFFFFFFF

Execution conditions

- Issued on **Insert/Update Non-Provisioned Device to Database** button press

Insert/Update Device to Database

FIGURE 15-23: ADD DEVICE TO DATABASE PUSH BUTTON

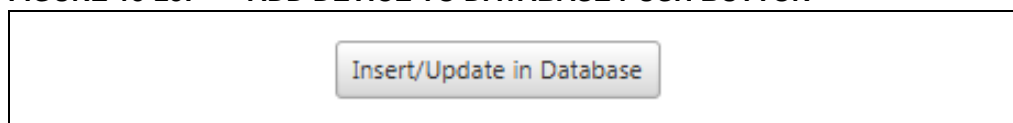

A screenshot of a push button labeled "Insert/Update in Database".

Description

This push button is used to issue the MySQL command to **Insert/Update** a row in the OTAA Devices Database table. Required parameters are parsed from the fields under the **Insert/Update Non-Provisioned (OTAA) Device** titled pane.

Execution conditions

- MySQL command issued on press

Effects Databases

- lora_application

MySQL Command

- INSERT INTO 'joinnotes' ('eui', 'appEui', 'appKey') VALUES ('DevEUI', 'AppEUI', 'AppKey')
- UPDATE joinnotes SET appEui = 'AppEUI', appKey = 'AppKey',
- WHERE eui = 'DevEUI'

Queue End-Device Downlink

FIGURE 15-24: QUEUE END DEVICE DOWNLINK TITLED PANE

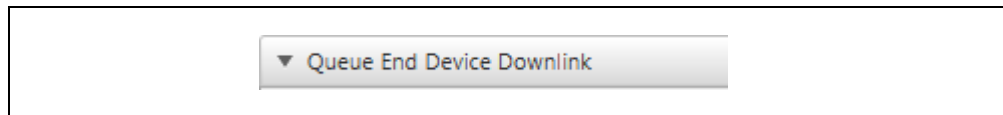

Description

Collapsible titled pane ([Figure 15-24](#)) used to Queue Downlink Payload Message, on a requested Port Number to be issued to the specified Device Address (DevAddr) upon its next confirmed Uplink packet.

Execution conditions

- Left click on field

Device Address (DevAddr)

FIGURE 15-25: DEVICE ADDRESS TEXT FIELD



Description

This text field is used to specify the Device Address (DevAddr) which will have a Queue Downlink Message ready for it upon its next Issued Confirmed Uplink ([Figure 15-25](#)).

Valid Range

- 0x0 - 0xFFFFFFFF

Execution conditions

- Issued on **Queue Downlink Message** button press

Downlink Port Number

FIGURE 15-26: DOWNLINK PORT TEXT FIELD



Description

This text field is used to specify the Downlink Port Number that will be used when the Queue message is transmitted ([Figure 15-26](#)).

Valid Range

- 0 - 255

Execution conditions

- Issued on **Queue Downlink Message** button press

Downlink Payload

FIGURE 15-27: DONWLINK PAYLOAD TEXT FIELD

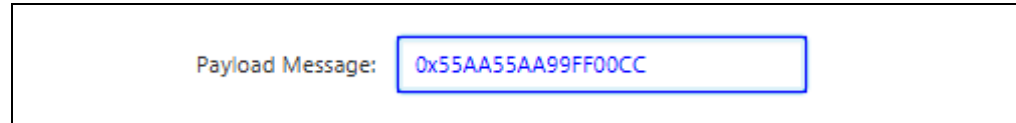

Description

This text field contains the data Payload Message that will be transmitted via the Downlink to the End Device, using the specified DevAddr (Figure 15-27).

Valid Range

- 0x0 - 0xFFFFFFFFFFFFFFFFFFFFFFFF

Execution conditions

- Issued on **Queue Downlink Message** button press

Queue Downlink Message

FIGURE 15-28: QUEUE DOWNLINK MESSAGE PUSH BUTTON



Description

This push button is used to issue the MySQL command which will insert the Queue message into the appropriate MySQL table (Figure 15-28). Once inserted into the table, a JSON UDP message is issued to the LoRa Server, containing the appropriate information. The Utility pushes a MySQL insert; the Server detects the data change. The Server then passes the data from Customer Server up to the Network Server. The Downlink is then queued and will be issued upon the next confirmed message from the specified End Device. Required parameters are parsed from the fields under the **Queue End Device Downlink** titled pane.

Execution conditions

- MySQL command issued on press

Effects Databases

- test

MySQL Command

- `INSERT INTO javatrigger VALUES ('DevAddr', 'dn', 'QueuePortNumber', 'QueuePayload', 'QueueIsSentStatus', NULL)`

JSON Packet

EXAMPLE 15-1: TITLE

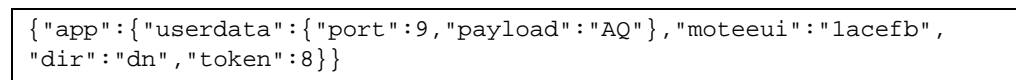

15.3.2 Database Tab Description

Below are the interactive elements of the tab for the Database Device Model, as represented in [Figure 15-29](#):

1. Structures
2. Database MySQL Table selector
3. Refresh Data
4. Polling Rate
5. Start/Stop Polling
6. Delete Row
7. Change Region

FIGURE 15-29: DATA TAB LAYOUT

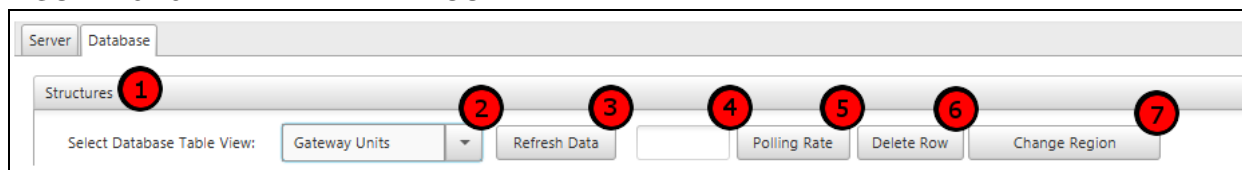

Database Structures View Pane

FIGURE 15-30: STRUCTURES VIEW PANE

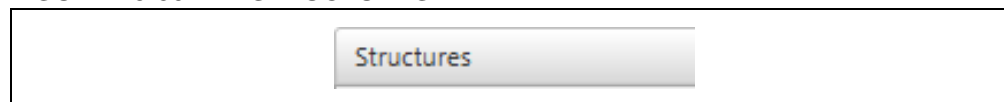

Description

This pane is used to display all information related to the selected database view, and is populated with a table created from the MySQL properties ([Figure 15-30](#)).

Execution conditions

- Left click on field

Database MySQL Table Selector

FIGURE 15-31: DATABASE MYSQL TABLE COMBO BOX

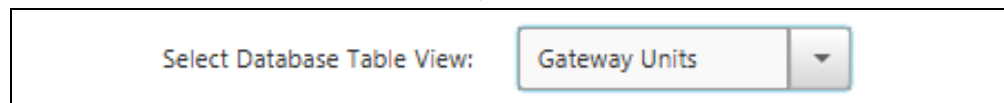

Description

This combo box is used to select the Database Table for display within the model view ([Figure 15-31](#)).

Database Tables

- Data Traffic
- Server Applications
- Gateway Units
- ABP Devices
- OTAA Devices

Execution Conditions

- Table and display data updated upon selection

Polling Rate

FIGURE 15-32: POLLING RATE TEXT FIELD

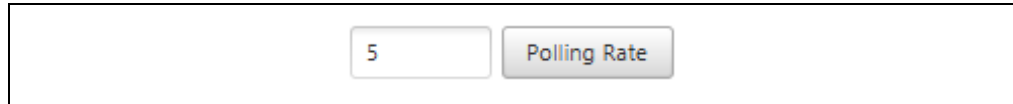

Description

This push button is used to start the polling timer. If the timer is active, this button is also used to stop it (Figure 15-32).

Execution conditions

- Button is pressed

Utility Action

- Issues MySQL Select request, updates table displays
- Manages timer states and method calls

Delete Row

FIGURE 15-33: DELETE ROW PUSH BUTTON

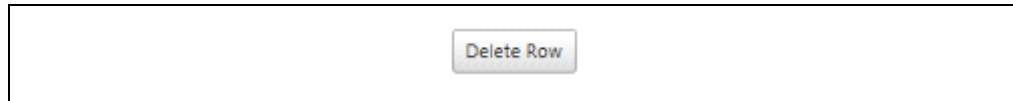

Description

This push button is used to delete the selected row and its elements from the database (Figure 15-33).

Execution conditions

- Button is pressed

Utility Action

- Issues a MySQL Delete on the selected row

Table: Data Traffic

Databases: lora_customer

Structures: appdata

Command: `DELETE FROM appdata WHERE id = 'Index'`

Table: Application Servers

Databases: lora_network, lora_application, lora_customer

Structures: applications

Command: `DELETE FROM applications WHERE eui = 'AppEUI'`

Table: Application Servers

Databases: lora_network

Structures: gateways

Command: `DELETE FROM gateways WHERE eui = 'GatewayID'`

Table: ABP Devices

Databases: lora_network , lora_application

Structures: motes, activemotes

Command: `DELETE FROM motes WHERE eui = 'DevAddr'`

`DELETE FROM activemotes WHERE eui = 'DevAddr'`

Table: ABP Devices

Databases: lora_application

Structures: joinmotes

Command: DELETE FROM joinmotes WHERE eui = 'DevEUI'

Change Gateway Region Operation

FIGURE 15-34: CHANGE REGION PUSH BUTTON

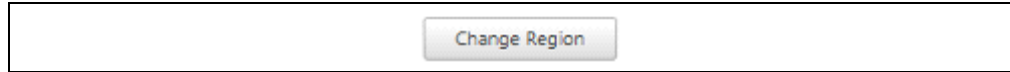

Description

This push button is visible only when **Gateway Units** is the selected table view (Figure 15-34). This will alter the operation region of the selected gateway unit between North America and Europe. Correct Region selection is required for use with the example LoRa servers provided.

Execution conditions

- Button is pressed

Utility Action

- Issues a MySQL Update to the selected row's Region column

Database

- lora_network

MySQL Command

- UPDATE gateways SET region = 'Region'
- WHERE eui = 'GatewayID'

Region Values

- 0 – North America; 915 MHz
- 4 – Europe; 868 MHz

15.3.3 Data Traffic Table Description

Below is a description of the database Data Traffic Table populated in the Device Model, as represented in [Figure 15-35](#):

1. Uplink Index Number
2. Uplink Raw Data
3. Uplink Data ASCII conversion
4. Device Address
5. Sequence Number
6. Accurate Time
7. Receive Port Number
8. Reception Timestamp
9. Time Microseconds

FIGURE 15-35: DATA TRAFFIC TABLE LAYOUT

Index	Data	Ascii Data	DevAddr	Sequence Number	Accurate Time	Rx Port	Time	time uSec
#2	0x424143	BAC	0x2	8	8	14	2015-12-30 10:5...	5
#3	0x012321	#!	0x1756923	11	0	99	2015-12-30 18:3...	0
#4	0x48656c6c6f	Hello	0x1756923	12	0	42	2015-12-30 19:0...	0
#5	0x54657374696e67	Testing	0x1756923	13	0	99	2015-12-30 19:0...	0
#6	0x616761696e	again	0x1756923	14	0	102	2015-12-30 19:0...	0
#7	0x48656c6c6f20546875722054657374	Hello Thur Test	0x1756923	1	0	125	2016-01-07 21:2...	0
#8	0x54657374696e6720436f6e6669726d6564	Testing Confirmed	0x1756923	2	0	55	2016-01-07 22:1...	0
#9	0x54657374696e6720436f6e6669726d6564	Testing Confirmed	0x1756923	3	0	55	2016-01-07 22:1...	0
#10	0x54657374696e6720436f6e6669726d6564	Testing Confirmed	0x1756923	4	0	55	2016-01-07 22:2...	0
#11	0x0123	#	0x1756923	0	0	25	2016-01-13 18:0...	0
#12	0x0123	#	0x1756923	1	0	25	2016-01-13 18:0...	0
#13	0x99	◆	0x1756923	2	0	125	2016-01-13 18:5...	0
#14	0x48656c6c6f	Hello	0x1756923	3	0	99	2016-01-13 20:4...	0
#15	0x48656c6c6f	Hello	0x1756923	4	0	99	2016-01-13 20:4...	0
#16	0x0123	#	0x1756923	5	0	99	2016-01-13 20:4...	0

Uplink Index Number

FIGURE 15-36: INDEX COLUMN

Index
#2
#3

Description

This column shows the numerical value for each received LoRa Uplink packet (Figure 15-36). Each row is numerically incremented by the database upon creation.

Display Type

- Incremental numerical values

Uplink Raw Data

FIGURE 15-37: UPLINK RAW DATA COLUMN

Data
0x424143
0x012321
0x48656c6c6f
0x54657374696e67

Description

This column shows the raw data payload after decryption from the LoRa Server (Figure 15-37).

Display Type

- Up to 10-Byte Hexadecimal

Uplink Data ASCII Conversion

FIGURE 15-38: ASCII DATA COLUMN

Ascii Data
BAC
#!
Hello
Testing

Description

This column shows the ASCII display of received data payload (Figure 15-38).

Display Type

- String

Device Address

FIGURE 15-39: DEVICE ADDRESS COLUMN

DevAddr
0x2
0x1756923

Description

This column shows the Device Address of the End Device which issued the Uplink transmission ([Figure 15-39](#)).

Display Type

- Up to 4-Byte Hexadecimal

Sequence Number

FIGURE 15-40: SEQUENCE NUMBER COLUMN

Sequence Number
8
11

Description

This column shows the Sequence Number contained within the LoRa Uplink header ([Figure 15-40](#)).

Display Type

- 2-Byte Decimal value

Accurate Time

FIGURE 15-41: ACCURATE TIME COLUMN

Accurate Time
8
0

Description

This column shows the Accurate Time value stored within the Uplink packet ([Figure 15-41](#)).

Display Type

- 2-Byte Decimal value

Receive Port Number

FIGURE 15-42: RECEIVE PORT NUMBER COLUMN

Rx Port
14
99

Description

This column shows the port number the Uplink transmission was received on ([Figure 15-42](#)).

Display Type

- 1-Byte Decimal value

Reception Timestamp

FIGURE 15-43: RECEPTION TIMESTAMP COLUMN

Time
2015-12-30 10:57:35.0
2015-12-30 18:33:31.0
2015-12-30 19:01:35.0

Description

This column shows the timestamp at the point of packet reception by the Server ([Figure 15-43](#)).

Display Type

- Timestamp format

Time Microseconds

FIGURE 15-44: TIMEFRAME COLUMN

time uSec
5
0

Description

This column shows the **time uSec** stamp received with the packet ([Figure 15-44](#)).

Display Type

- 1-Byte Decimal value

15.3.4 Application Servers Table Description

Below is a description of the database Application Servers Table populated in the Device Model, as represented in [Figure 15-45](#):

1. Application Server Extended-Unique-Identifier (AppEUI)
2. Application Server Name
3. Application Server Owner

FIGURE 15-45: APPLICATION SERVERS TABLE LAYOUT

Server Application EUI	Name	Owner
0x0	defaultApp	
0xFFFFFFFFFFFFFFFE	null	
0x11	Testing	OTAA

Application Server Extended-Unique-Identifier (AppEUI)

FIGURE 15-46: AppEUI COLUMN

Application Server EUI
0x0
0xFFFFFFFFFFFFFFFE
0x1A2B3C

Description

This column shows the valid Application Servers (AppEUI) which exist within the database ([Figure 15-46](#)).

Display Type

- Up to 8-Byte Hexadecimal

Application Server Name

FIGURE 15-47: SERVER NAME COLUMN

Name
defaultApp
null
OTAA

Description

This column shows the Name allocated for the Application Server ([Figure 15-47](#)).

Display Type

- String

Application Server Owner

FIGURE 15-48: SERVER OWNER COLUMN



Owner
Testing
Microchip

Description

This column shows the Owner responsible for the Application Server ([Figure 15-48](#)).

Display Type

- String

15.3.5 Gateway Units Table Description

Below is a description of the database Gateway Units Table populated in the Device Model, as represented in [Figure 15-49](#):

1. Gateway Identifier
2. Connection Timestamp
3. Latitude
4. Longitude
5. Altitude
6. Uplink Packets Received
7. Good Uplink Packets Received
8. Uplink Packets Forwarded
9. Uplink Packets Acknowledged
10. Downlink Packets Received
11. Downlink Packets Transmitted
12. Last Uplink Packet Identifier
13. Gateway Region of Operation
14. Allow GPS to Set Position

FIGURE 15-49: GATEWAY UNITS TABLE LAYOUT

Gateway ID	Time	Latitude	Longitude	Altitude	Up Pckts Rx	Good Up Pckts Rx	Up Pckts Fwr	Up Pckts Ack Ratio	Down Pckts Rx	Pckts Tx	Last Up Pckts ID	Region	Allow Gps To Set Position
0x12345678876543	2011-01-01 06:33:00			5800				364525					

Gateway Identifier

FIGURE 15-50: GATEWAY ID COLUMN

Gateway ID
0x1234567887654321

Description

This column shows all Gateway ID of units which have connected to the LoRaWAN network (Figure 15-50).

Display Type

- Up to 8-Byte Hexadecimal

Connection Timestamp

FIGURE 15-51: CONNECTION TIMESTAMP COLUMN

Time
2011-01-01 11:06:35.0

Description

This column shows the initial time the gateway unit connected to the LoRaWAN network (Figure 15-51).

Display Type

- Timestamp

Latitude

FIGURE 15-52: LATITUDE COLUMN



Description

This column shows the Latitude at which the gateway unit is said to operate at, if available ([Figure 15-52](#)).

Display Type

- 2-Byte Decimal value

Longitude

FIGURE 15-53: LONGITUDE COLUMN

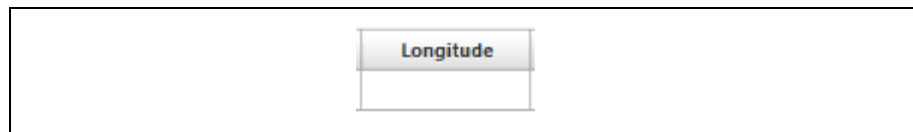

Description

This column shows the Longitude at which the gateway unit is said to operate at, if available ([Figure 15-53](#)).

Display Type

- 2-Byte Decimal value

Altitude

FIGURE 15-54: ALTITUDE COLUMN



Description

This column shows the Altitude at which the gateway unit is said to operate at, if available ([Figure 15-54](#)).

Display Type

- 2-Byte Decimal value

Uplink Packets Received

FIGURE 15-55: RECEIVED UPLINK PACKETS COLUMN

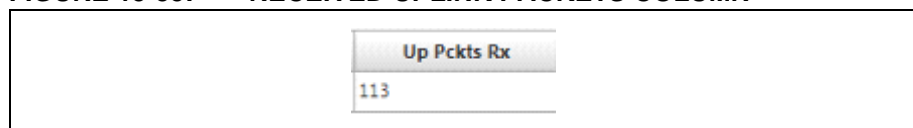

Description

This column shows the number of Uplink Packets received from that gateway unit ([Figure 15-55](#)).

Display Type

- 2-Byte Decimal value

Good Uplink Packets Received

FIGURE 15-56: RECEIVED GOOD UPLINK PACKETS COLUMN



Description

This column shows the number of Uplink packets which have been forwarded by the gateway unit (Figure 15-56).

Display Type

- 2-Byte Decimal value

Uplink Packets Forwarded

FIGURE 15-57: FORWARDED UPLINK PACKETS COLUMN



Description

This column shows the number of Uplink packets which have been forwarded by the gateway unit (Figure 15-57).

Display Type

- 2-Byte Decimal value

Uplink Packets Acknowledged

FIGURE 15-58: ACKNOWLEDGED UPLINK PACKETS COLUMN

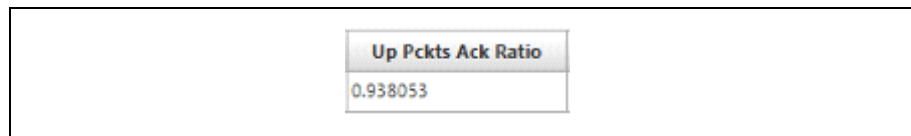

Description

This column shows numerical representation of the Uplink Packet Acknowledgement Ratio (Figure 15-58).

Display Type

- Float

Downlink Packets Received

FIGURE 15-59: RECEIVED DOWNLINK PACKETS COLUMN

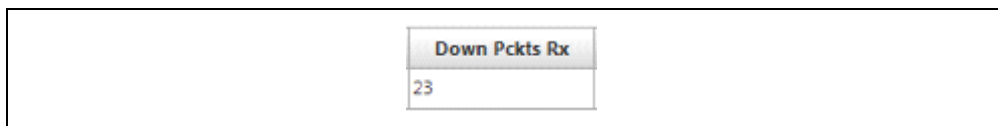

Down Pckts Rx
23

Description

This column shows the number of Downlink packets which have been received by the gateway unit (Figure 15-59).

Display Type

- 2-Byte Decimal value

Downlink Packets Transmitted

FIGURE 15-60: TRANSMITTED DOWNLINK PACKETS COLUMN

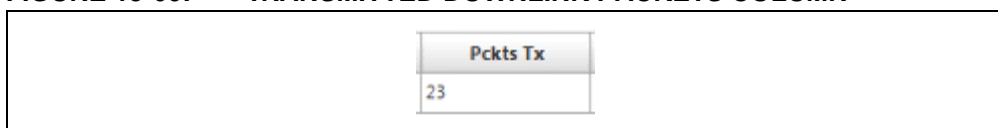

Pckts Tx
23

Description

This column shows the number of Downlink packets which the gateway unit has transmitted (Figure 15-60).

Display Type

- 2-Byte Decimal value

Last Uplink Packet Identifier

FIGURE 15-61: LAST UPLINK PACKET ID COLUMN



Last Up Pckts ID

Description

This column shows the last received Uplink packets tagged ID, if available (Figure 15-61).

Display Type

- 2-Byte Decimal value

Gateway Region of Operation

FIGURE 15-62: GATEWAY REGION OF OPERATION COLUMN

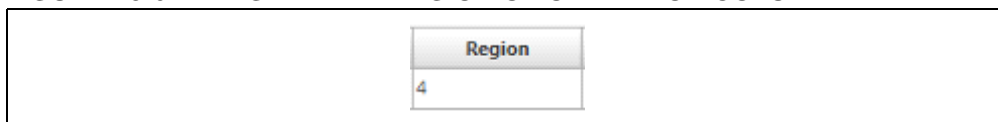

Region
4

Description

This column shows the region of operation for the gateway unit (Figure 15-62).

Display Type

- 1-Byte Decimal value

Allow GPS to Set Position

FIGURE 15-63: ALLOW GPS TO SET POSITION COLUMN

<input type="text" value="Allow Gps To Set Positi..."/> <input type="text" value="1"/>

Description

This column is show if the gateway unit has a GPS which is capable of giving the operating latitude, longitude and altitude positions (Figure 15-63).

Display Type

- 1-Byte Decimal value

15.3.6 ABP Devices Table Description

Below is a description of the database ABP Devices Table populated in the Device Model, as represented in Figure 15-64:

1. Device Extended-Unique-Identifier (DevEUI)
2. Application Extended-Unique-Identifier (AppEUI)
3. Device Address (DevAddr)
4. Network Session Key (NwkSKey)
5. Downlink Message Sequence Number
6. Uplink Message Sequence Number
7. Application Session Key (AppSKey)

FIGURE 15-64: ABP DEVICES TABLE LAYOUT

DevEUI	AppEUI	DevAddr	Network Session Key	Down Message Seq No	Up Message Seq No	Application Session Key
0x1A3FCA	0x0	0x1A3FCA	0x2b7e151628aed2a6abf7158809cf4f3c	0	0	0x3c8f262739bfe3b7bc0826991ad0504d
0x109	0x0	0x109	0x2b7e151628aed2a6abf7158809cf4f3c	0	1	0x3c8f262739bfe3b7bc0826991ad0504d
0x33	0x11	0x48000000	0x1d9065697420009ddcc9c04cfd07954b	0	0	0xb906dc3f5630862da9591855e76491ec

Device Extended-Unique-Identifier (DevEUI)

FIGURE 15-65: DevEUI COLUMN

DevEUI
0x1A8C44
0x1A8F1E

Description

This column shows all Device Extended-Unique-Identifier for a valid Provisioned (ABP) End Device ([Figure 15-65](#)).

Display Type

- Up to 8-Byte Hexadecimal

Application Extended-Unique-Identifier (AppEUI)

FIGURE 15-66: AppEUI COLUMN

AppEUI
0x0
0x0

Description

This column shows which Application Server the End Device belongs to ([Figure 15-66](#)).

Display Type

- Up to 8-Byte Hexadecimal

Device Address (DevAddr)

FIGURE 15-67: DEVICE ADDRESS COLUMN

DevAddr
0x1A8C44
0x1A8F1E

Description

This column shows the Device Address given to the End Device within its Application Server ([Figure 15-67](#)).

Display Type

- Up to 4-Byte Hexadecimal

Network Session Key (NwkSKey)

FIGURE 15-68: NwkSKey COLUMN

Network Session Key
0x2b7e151628aed2a6abf7158809cf4f3c
0x2b7e151628aed2a6abf7158809cf4f3c
0x1d9065697420009ddcc9c04cfd07954b

Description

This column shows the Network Session Key given to the End Device for use within the LoRa Network Server (Figure 15-68).

Display Type

- Up to 16-Byte Hexadecimal

Downlink Message Sequence Number

FIGURE 15-69: DOWNLINK MESSAGE SEQUENCE NUMBER COLUMN

Down Message Seq No
0
0

Description

This column shows the current Downlink Message Sequence Number the End Device has been issued (Figure 15-69). In most networks this sequence number represents how many Downlink Messages the End Device has received within the LoRaWAN network.

Display Type

- Up to 16-Byte Hexadecimal

Uplink Message Sequence Number

FIGURE 15-70: UPLINK MESSAGE SEQUENCE NUMBER COLUMN

Up Message Seq No
0
0

Description

This column shows the current Uplink Message Sequence Number the End Device has reached (Figure 15-70). In most networks this sequence number represents how many Uplink Messages that End Device has done within the LoRaWAN network.

Display Type

- Up to 16-Byte Hexadecimal

Application Session Key (AppSKey)

FIGURE 15-71: AppSKey COLUMN

Application Session Key
0x3C8F2627398FE387BC0826991AD0504D
0x3C8F2627398FE387BC0826991AD0504D

Description

This column shows the Application Session Key given to the End Device for use within the LoRa Application Server (Figure 15-71).

Display Type

- Up to 16-Byte Hexadecimal

15.3.7 OTAA Devices Table Description

Below is a description of the database OTAA Devices Table populated in the Device Model, as represented in Figure 15-72:

1. Device Address (DevAddr)
2. Application Extended-Unique-Identifier (AppEUI)
3. Application Key (AppKey)

FIGURE 15-72: OTAA DEVICES TABLE LAYOUT

DevAddr	AppEUI	AppKey
0x33	0x11	0x22

Device Address (DevAddr)

FIGURE 15-73: DEVICE ADDRESS COLUMN

DevAddr
0x55AA
0x4A30B001ACEFB

Description

This column shows the Device Address for valid Non-Provisioned (OTAA) end devices (Figure 15-73).

Display Type

- Up to 4-Byte Hexadecimal

Application Extended-Unique-Identifier (AppEUI)

FIGURE 15-74: AppEUI COLUMN

AppEUI
0xFF
0xABCDEF

Description

This column shows which Application Server the End Device wishes to join ([Figure 15-74](#)).

Display Type

- Up to 8-Byte Hexadecimal

Application Key (AppKey)

FIGURE 15-75: AppKey COLUMN

AppKey
0xABCDEF
0x1111111111

Description

This column shows the Application Key used by the End Device to gain access to join its desired server ([Figure 15-75](#)).

Display Type

- Up to 16-Byte Hexadecimal

LoRa[®] Technology Evaluation Suite User's Guide

NOTES:



MICROCHIP

Worldwide Sales and Service

AMERICAS

Corporate Office
2355 West Chandler Blvd.
Chandler, AZ 85224-6199
Tel: 480-792-7200
Fax: 480-792-7277
Technical Support:
<http://www.microchip.com/support>
Web Address:
www.microchip.com

Atlanta
Duluth, GA
Tel: 678-957-9614
Fax: 678-957-1455

Austin, TX
Tel: 512-257-3370

Boston
Westborough, MA
Tel: 774-760-0087
Fax: 774-760-0088

Chicago
Itasca, IL
Tel: 630-285-0071
Fax: 630-285-0075

Cleveland
Independence, OH
Tel: 216-447-0464
Fax: 216-447-0643

Dallas
Addison, TX
Tel: 972-818-7423
Fax: 972-818-2924

Detroit
Novi, MI
Tel: 248-848-4000

Houston, TX
Tel: 281-894-5983

Indianapolis
Noblesville, IN
Tel: 317-773-8323
Fax: 317-773-5453

Los Angeles
Mission Viejo, CA
Tel: 949-462-9523
Fax: 949-462-9608

New York, NY
Tel: 631-435-6000

San Jose, CA
Tel: 408-735-9110

Canada - Toronto
Tel: 905-673-0699
Fax: 905-673-6509

ASIA/PACIFIC

Asia Pacific Office
Suites 3707-14, 37th Floor
Tower 6, The Gateway
Harbour City, Kowloon

Hong Kong
Tel: 852-2943-5100
Fax: 852-2401-3431

Australia - Sydney
Tel: 61-2-9868-6733
Fax: 61-2-9868-6755

China - Beijing
Tel: 86-10-8569-7000
Fax: 86-10-8528-2104

China - Chengdu
Tel: 86-28-8665-5511
Fax: 86-28-8665-7889

China - Chongqing
Tel: 86-23-8980-9588
Fax: 86-23-8980-9500

China - Dongguan
Tel: 86-769-8702-9880

China - Hangzhou
Tel: 86-571-8792-8115
Fax: 86-571-8792-8116

China - Hong Kong SAR
Tel: 852-2943-5100
Fax: 852-2401-3431

China - Nanjing
Tel: 86-25-8473-2460
Fax: 86-25-8473-2470

China - Qingdao
Tel: 86-532-8502-7355
Fax: 86-532-8502-7205

China - Shanghai
Tel: 86-21-5407-5533
Fax: 86-21-5407-5066

China - Shenyang
Tel: 86-24-2334-2829
Fax: 86-24-2334-2393

China - Shenzhen
Tel: 86-755-8864-2200
Fax: 86-755-8203-1760

China - Wuhan
Tel: 86-27-5980-5300
Fax: 86-27-5980-5118

China - Xian
Tel: 86-29-8833-7252
Fax: 86-29-8833-7256

ASIA/PACIFIC

China - Xiamen
Tel: 86-592-2388138
Fax: 86-592-2388130

China - Zhuhai
Tel: 86-756-3210040
Fax: 86-756-3210049

India - Bangalore
Tel: 91-80-3090-4444
Fax: 91-80-3090-4123

India - New Delhi
Tel: 91-11-4160-8631
Fax: 91-11-4160-8632

India - Pune
Tel: 91-20-3019-1500

Japan - Osaka
Tel: 81-6-6152-7160
Fax: 81-6-6152-9310

Japan - Tokyo
Tel: 81-3-6880-3770
Fax: 81-3-6880-3771

Korea - Daegu
Tel: 82-53-744-4301
Fax: 82-53-744-4302

Korea - Seoul
Tel: 82-2-554-7200
Fax: 82-2-558-5932 or
82-2-558-5934

Malaysia - Kuala Lumpur
Tel: 60-3-6201-9857
Fax: 60-3-6201-9859

Malaysia - Penang
Tel: 60-4-227-8870
Fax: 60-4-227-4068

Philippines - Manila
Tel: 63-2-634-9065
Fax: 63-2-634-9069

Singapore
Tel: 65-6334-8870
Fax: 65-6334-8850

Taiwan - Hsin Chu
Tel: 886-3-5778-366
Fax: 886-3-5770-955

Taiwan - Kaohsiung
Tel: 886-7-213-7828

Taiwan - Taipei
Tel: 886-2-2508-8600
Fax: 886-2-2508-0102

Thailand - Bangkok
Tel: 66-2-694-1351
Fax: 66-2-694-1350

EUROPE

Austria - Wels
Tel: 43-7242-2244-39
Fax: 43-7242-2244-393

Denmark - Copenhagen
Tel: 45-4450-2828
Fax: 45-4485-2829

France - Paris
Tel: 33-1-69-53-63-20
Fax: 33-1-69-30-90-79

Germany - Dusseldorf
Tel: 49-2129-3766400

Germany - Karlsruhe
Tel: 49-721-625370

Germany - Munich
Tel: 49-89-627-144-0
Fax: 49-89-627-144-44

Italy - Milan
Tel: 39-0331-742611
Fax: 39-0331-466781

Italy - Venice
Tel: 39-049-7625286

Netherlands - Drunen
Tel: 31-416-690399
Fax: 31-416-690340

Poland - Warsaw
Tel: 48-22-3325737

Spain - Madrid
Tel: 34-91-708-08-90
Fax: 34-91-708-08-91

Sweden - Stockholm
Tel: 46-8-5090-4654

UK - Wokingham
Tel: 44-118-921-5800
Fax: 44-118-921-5820

07/14/15