

# 0.4 mm Contact Pitch, Board-to-FPC Connectors

## BM14 Series

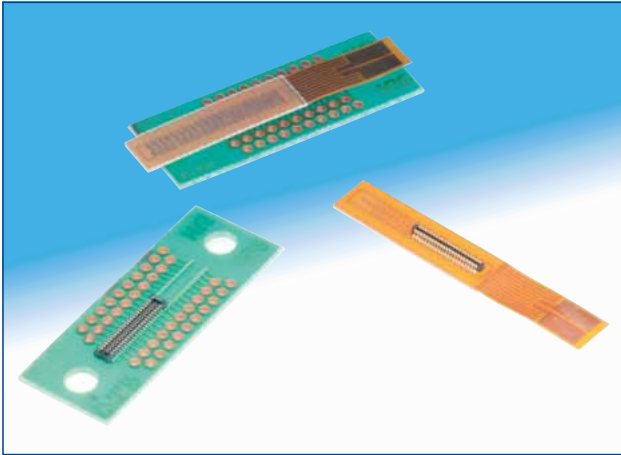

### ■ Features

#### 1. Two stacking height options

Two separate heights available: 0.8 and 1.3 mm

#### 2. Ultra space-saving design

With its drastically reduced depth of 1.98 mm, this series can fit in the tightest designs.

#### 3. Two point contact system

The two point contact structure encloses the plug contacts and assures a completely secure connection. (Fig.1)

#### 4. Superior tactile feedback

A clear tactile click is delivered upon the successful completion of the mating process (Fig. 2).

#### 5. Drop and shock resistant structure

Dimples were designed into the plug contacts; they increase retention force and absorb shock when dropped.

#### 6. User friendly operations

The low-profile connectors with stacking height of 0.8 mm maintain the mating self-alignment range of 0.3 mm, securing easy mating operations.

#### 7. No pattern prohibited area

No restrictions on PCB layout pattern are imposed, as thin molding technology maintains the effective mating length of 0.2 mm while achieving complete insulation between the bottom side of the receptacle and the board.

Mating Cross-Section Diagram (H = 0.8 mm type)

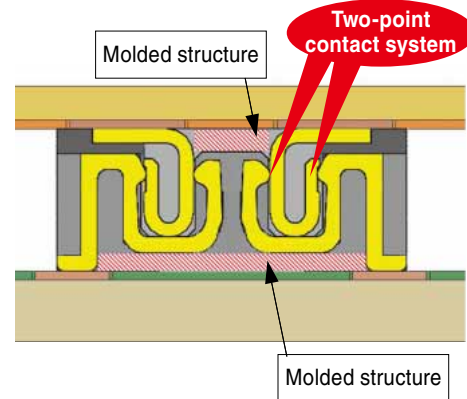

The molded structure provides security and insulation between the terminals and the board

Fig. 1

Solid mating feedback

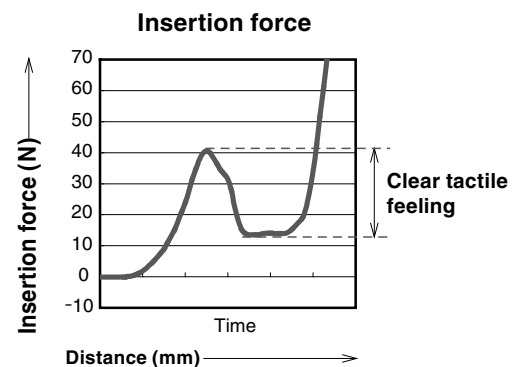
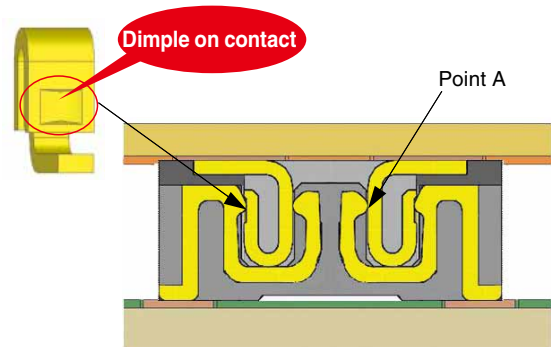

Image: 0.8 mm stacking height

Fig. 2

## Product Specifications

Ratings	Current capacity	0.3A	Operating temperature range Operating humidity range	-35°C to +85°C (Note 1) 20% to 80% RH
	Rated voltage	30V AC, DC	Storage temperature range Storage humidity range	-10°C to +60°C (Note 2) 40% to 70% RH (Note 2)

Item	Specification	Conditions
1. Insulation resistance	Minimum of 500 MΩ	100V DC
2. Withstanding voltage	No flashover or insulation breakdown	100V AC / 1 minute
3. Contact resistance	Maximum of 100 mΩ	20mV AC, 1 kHz, 1mA
4. Vibration	No electrical discontinuity of 1 μs or longer	Frequency: 10 to 55 Hz, single amplitude of 0.75 mm, 2 hours in each of the 3 directions
5. Humidity	Contact resistance: Maximum of 100 mΩ Insulation resistance: Minimum of 25 MΩ	96 hours at 40 ±2°C and humidity of 90 to 95%
6. Temperature cycle	Contact resistance: Maximum of 100 mΩ Insulation resistance: Minimum of 50 MΩ	Temperature: -55°C → 5 to 35°C → 85°C → 5 to 35°C Time: 30 → 10 → 30 → 10 (minutes) 5 cycles
7. Durability (mating/unmating)	Contact resistance: Maximum of 100 mΩ	10 mating cycles
8. Resistance to soldering heat	No deformation of components affecting performance	Reflow: At the recommended temperature profile Manual soldering: 350°C for 3 seconds

Note 1: Includes temperature rise caused by current flow.

Note 2: The term "storage" here refers to products stored for a long period prior to board mounting and use. The operating temperature and humidity range covers the non-energized condition of connectors after board mounting and the temporary storage conditions during transportation, etc.

## Materials

Product	Component	Material	Color/Finish	Remarks
Receptacle	Insulator	LCP	Color: Black	UL94V-0
Header	Contacts	Phosphor bronze	Gold plated	—

## Product Number Structure

Refer to this page when determining product specifications by model types. Please place orders with part numbers listed in this catalog. The characteristics and specifications of the product described in this catalog are reference values. Please make sure to check the latest delivery specifications at the time of product use.

### ● Receptacles / Headers

**BM 14 # (\*\*\*) - \* DS - 0.4 V (\*\*)**

① ② ③ ④ ⑤ ⑥ ⑦ ⑧ ⑨

① Series name : BM	⑥ Connector style DS: Double-row receptacle DP: Double-row plug
② Series No.: 14	
③ Configuration B : With metal fittings C : Without metal fittings EB : With metal fittings EC : Without metal fittings JB : Connector for conductivity tests, with metal fittings JC : Connector for conductivity tests, without metal fittings	
④ Stacking heights: 0.8 mm, 1.3 mm	
⑤ Number of contacts:	
	⑦ Contact pitch: 0.4 mm
	⑧ Termination type V: SMT vertical mount
	⑨ Packaging (51) : Embossed tape packaging (8,000 pieces per reel) (52) : Embossed tape packaging with pick-and-place tape (8,000 pieces per reel) (55) : Embossed tape packaging (500 pieces per reel)

## H = 0.8 mm Receptacle

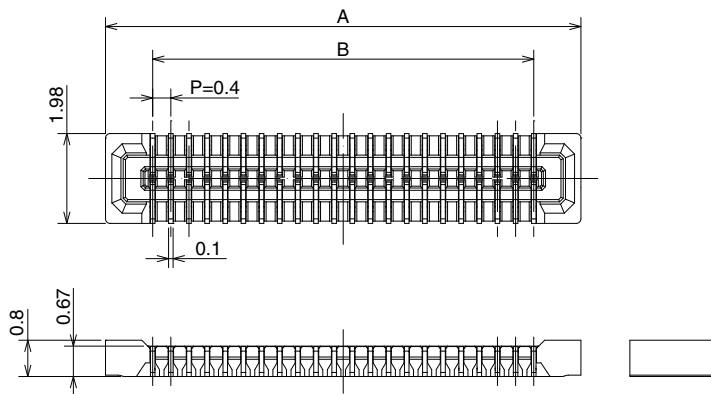
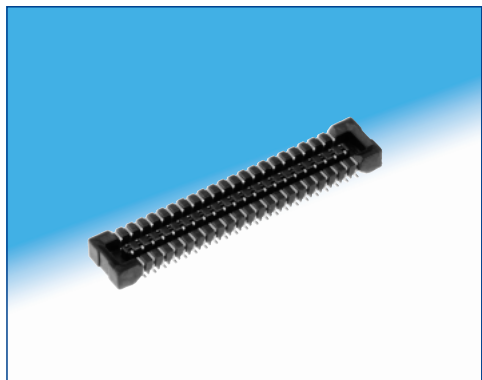

### Recommended PCB layout (H = 0.8 mm)

#### With metal fittings

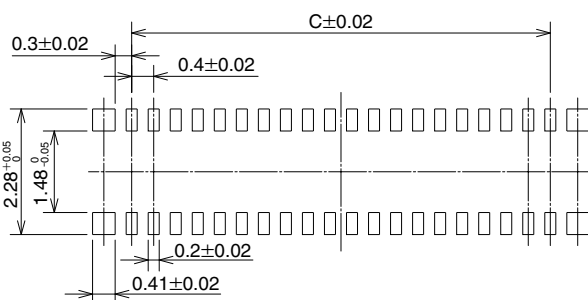

#### Without metal fittings

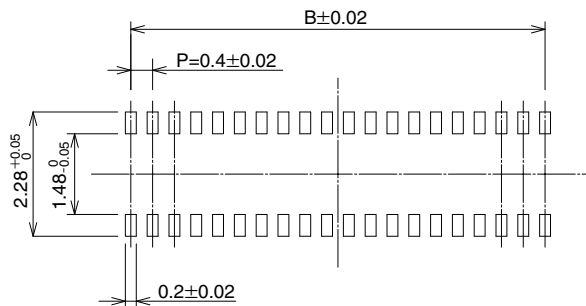

#### With metal fittings

Unit: mm

Part No.	HRS No.	No. of Contacts	A	B	C
BM14B(0.8)-10DS-0.4V(51)	684-8003-5 51	10	4.48	2.4	1.6
BM14B(0.8)-12DS-0.4V(51)	684-8041-4 51	12	4.88	2.8	2.0
BM14B(0.8)-20DS-0.4V(51)	684-8004-8 51	20	6.48	4.4	3.6
BM14B(0.8)-22DS-0.4V(51)	684-8048-3 51	22	6.88	4.8	4.0
BM14B(0.8)-24DS-0.4V(51)	684-8005-0 51	24	7.28	5.2	4.4
BM14B(0.8)-30DS-0.4V(51)	684-8006-0 51	30	8.48	6.4	5.6
BM14B(0.8)-34DS-0.4V(51)	684-8007-6 51	34	9.28	7.2	6.4
BM14B(0.8)-40DS-0.4V(51)	684-8008-9 51	40	10.48	8.4	7.6
BM14B(0.8)-50DS-0.4V(51)	684-8009-1 51	50	12.48	10.4	9.6
BM14B(0.8)-60DS-0.4V(51)	684-8001-0 51	60	14.48	12.4	11.6

#### Without metal fittings

Unit: mm

Part No.	HRS No.	No. of Contacts	A	B
BM14C(0.8)-14DS-0.4V(51)	684-8017-0 51	14	4.48	2.4
BM14C(0.8)-16DS-0.4V(51)	684-8039-2 51	16	4.88	2.8
BM14C(0.8)-24DS-0.4V(51)	684-8018-2 51	24	6.48	4.4
BM14C(0.8)-26DS-0.4V(51)	684-8046-8 51	26	6.88	4.8
BM14C(0.8)-28DS-0.4V(51)	684-8019-5 51	28	7.28	5.2
BM14C(0.8)-34DS-0.4V(51)	684-8020-4 51	34	8.48	6.4
BM14C(0.8)-38DS-0.4V(51)	684-8021-7 51	38	9.28	7.2
BM14C(0.8)-44DS-0.4V(51)	684-8022-0 51	44	10.48	8.4
BM14C(0.8)-54DS-0.4V(51)	684-8023-2 51	54	12.48	10.4
BM14C(0.8)-64DS-0.4V(51)	684-8024-5 51	64	14.48	12.4

Note 1 : Please place orders in full reel quantities.

Note 2 : The only difference between "with metal fittings" and "without metal fittings" is that the contacts at the four corners will be used as reinforcing metal fittings or signal contacts. There is no difference in the performance or dimensions of the connector.

Note 3 : This connector is NOT polarized.

## ■ H = 1.3 mm Receptacle

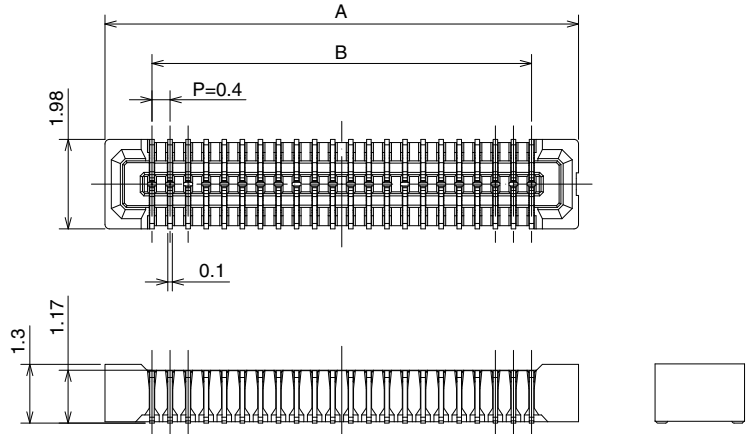
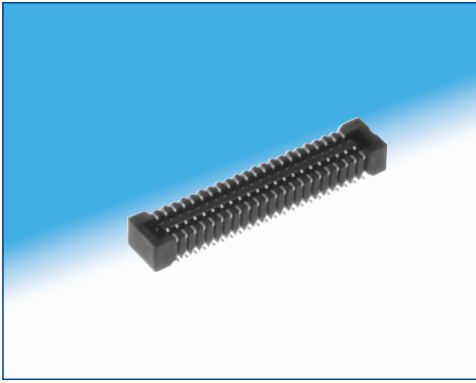

### ◆ Recommended PCB layout (H = 1.3 mm)

#### ● With metal fittings

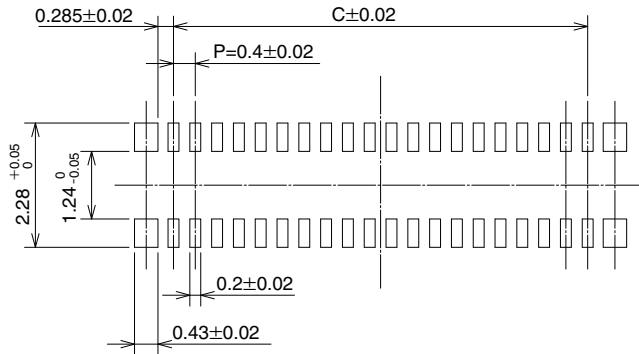

#### ● Without metal fittings

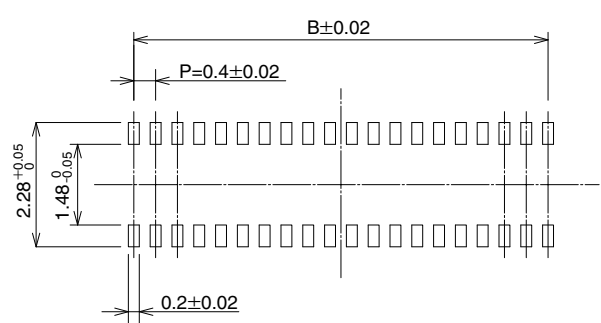

#### ● With metal fittings

Unit: mm

Part No.	HRS No.	No. of Contacts	A	B	C
BM14EB(1.3)-40DS-0.4V(51)	684-8174-8 51	40	10.48	8.4	7.6
BM14EB(1.3)-50DS-0.4V(51)	684-8178-9 51	50	12.48	10.4	9.6

#### ● Without metal fittings

Unit: mm

Part No.	HRS No.	No. of Contacts	A	B
BM14EC(1.3)-44DS-0.4V(51)	684-8155-3 51	44	10.48	8.4
BM14EC(1.3)-54DS-0.4V(51)	684-8157-9 51	54	12.48	10.4

Note 1 : Please place orders in full reel quantities.

Note 2 : The only difference between "with metal fittings" and "without metal fittings" is that the contacts at the four corners will be used as reinforcing metal fittings or signal contacts. There is no difference in the performance or dimensions of the connector.

Note 3 : This connector is NOT polarized.

## Connector for Conductivity Tests

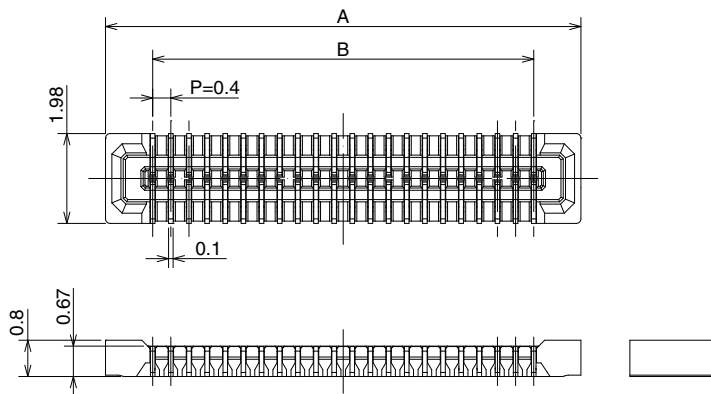
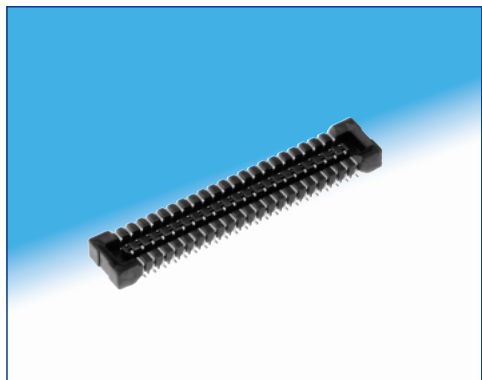

## Recommended PCB mounting pattern

### With metal fittings

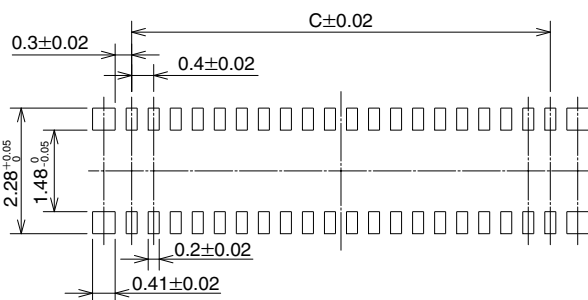

### Without metal fittings

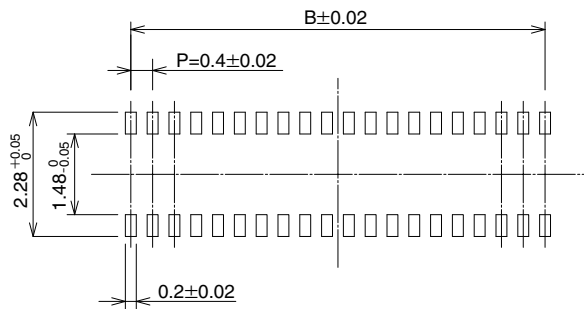

### With metal fittings

Unit: mm

Part No.	HRS No.	No. of Contacts	A	B	C
BM14JB-10DS-0.4V(55)	684-8225-7 55	10	4.48	2.4	1.6
BM14JB-20DS-0.4V(55)	684-8226-0 55	20	6.48	4.4	3.6
BM14JB-24DS-0.4V(55)	684-8227-2 55	24	7.28	5.2	4.4
BM14JB-30DS-0.4V(55)	684-8228-5 55	30	8.48	6.4	5.6
BM14JB-40DS-0.4V(55)	684-8230-7 55	40	10.48	8.4	7.6
BM14JB-50DS-0.4V(55)	684-8231-0 55	50	12.48	10.4	9.6
BM14JB-60DS-0.4V(55)	684-8232-2 55	60	14.48	12.4	11.6

### Without metal fittings

Unit: mm

Part No.	HRS No.	No. of Contacts	A	B
BM14JC-14DS-0.4V(55)	684-8416-5 55	14	4.48	2.4
BM14JC-24DS-0.4V(55)	684-8417-8 55	24	6.48	4.4
BM14JC-28DS-0.4V(55)	684-8419-3 55	28	7.28	5.2
BM14JC-34DS-0.4V(55)	684-8418-0 55	34	8.48	6.4
BM14JC-44DS-0.4V(55)	684-8409-0 55	44	10.48	8.4
BM14JC-54DS-0.4V(55)	684-8410-9 55	54	12.48	10.4
BM14JC-64DS-0.4V(55)	684-8411-1 55	64	14.48	12.4

Note 1 : Please place orders in full reel quantities.

Note 2 : The only difference between "with metal fittings" and "without metal fittings" is that the contacts at the four corners will be used as reinforcing metal fittings or signal contacts. There is no difference in the performance or dimensions of the connector.

Note 3 : This connector is NOT polarized.

## Header

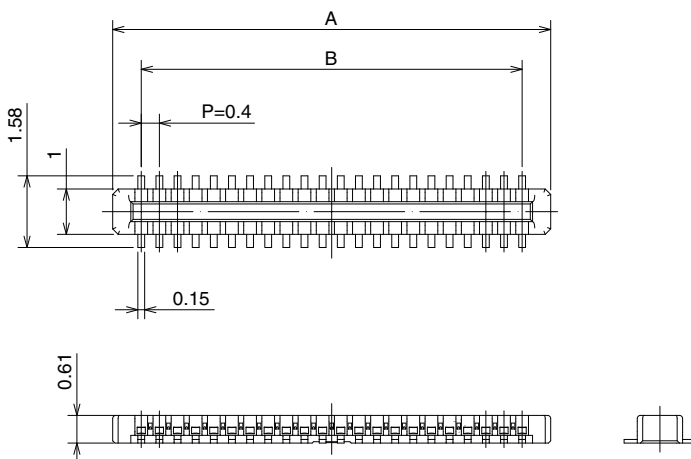

### Recommended PCB layout

#### With metal fittings

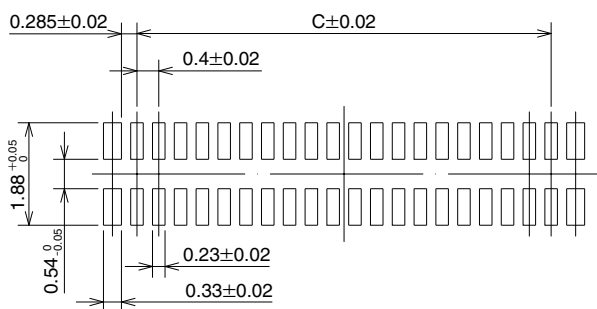

#### Without metal fittings

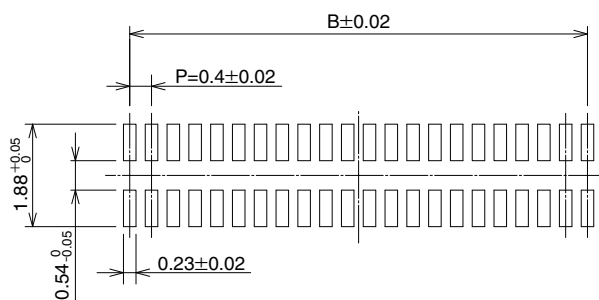

#### With metal fittings

Unit: mm

Part No.	HRS No.	No. of Contacts	A	B	C
BM14B(0.8)-10DP-0.4V(51)	684-8010-0 51	10	3.66	2.4	1.6
BM14B(0.8)-12DP-0.4V(51)	684-8042-7 51	12	4.06	2.8	2.0
BM14B(0.8)-20DP-0.4V(51)	684-8011-3 51	20	5.66	4.4	3.6
BM14B(0.8)-22DP-0.4V(51)	684-8047-0 51	22	6.06	4.8	4.0
BM14B(0.8)-24DP-0.4V(51)	684-8012-6 51	24	6.46	5.2	4.4
BM14B(0.8)-30DP-0.4V(51)	684-8013-9 51	30	7.66	6.4	5.6
BM14B(0.8)-34DP-0.4V(51)	684-8014-1 51	34	8.46	7.2	6.4
BM14B(0.8)-40DP-0.4V(51)	684-8015-4 51	40	9.66	8.4	7.6
BM14B(0.8)-50DP-0.4V(51)	684-8016-7 51	50	11.66	10.4	9.6
BM14B(0.8)-60DP-0.4V(51)	684-8002-2 51	60	13.66	12.4	11.6

#### Without metal fittings

Unit: mm

Part No.	HRS No.	No. of Contacts	A	B
BM14C(0.8)-14DP-0.4V(51)	684-8025-8 51	14	3.66	2.4
BM14C(0.8)-16DP-0.4V(51)	684-8040-1 51	16	4.06	2.8
BM14C(0.8)-24DP-0.4V(51)	684-8026-0 51	24	5.66	4.4
BM14C(0.8)-26DP-0.4V(51)	684-8045-5 51	26	6.06	4.8
BM14C(0.8)-28DP-0.4V(51)	684-8027-3 51	28	6.46	5.2
BM14C(0.8)-34DP-0.4V(51)	684-8028-6 51	34	7.66	6.4
BM14C(0.8)-38DP-0.4V(51)	684-8029-9 51	38	8.46	7.2
BM14C(0.8)-44DP-0.4V(51)	684-8030-8 51	44	9.66	8.4
BM14C(0.8)-54DP-0.4V(51)	684-8031-0 51	54	11.66	10.4
BM14C(0.8)-64DP-0.4V(51)	684-8032-3 51	64	13.66	12.4

Note 1 : Please place orders in full reel quantities.

Note 2 : The only difference between "with metal fittings" and "without metal fittings" is that the contacts at the four corners will be used as reinforcing metal fittings or signal contacts. There is no difference in the performance or dimensions of the connector.

Note 3 : This connector is NOT polarized.

## ◆ Embossed Carrier Tape Dimensions: H = 0.8 mm (JIS C 0806 Compliant)

### ● Receptacle

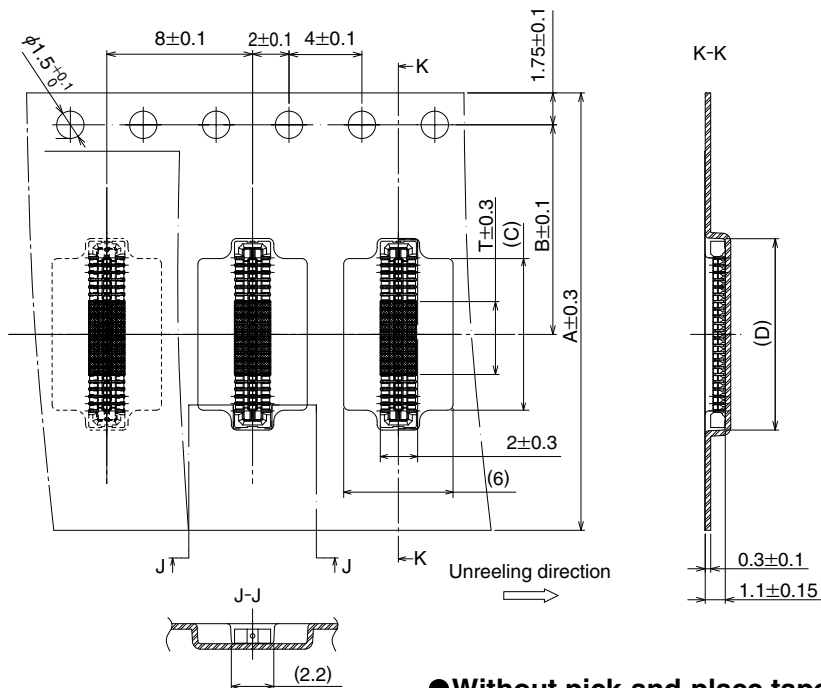

### ● Without pick-and-place tape

Unit: mm

Part No.	A	B	C	D	E	F
BM14B(0.8)-10DS-0.4V(51)	16	7.5	2.58	4.7	17.5	21.5
BM14B(0.8)-12DS-0.4V(51)			2.98	5.1		
BM14B(0.8)-20DS-0.4V(51)			4.58	6.7		
BM14B(0.8)-22DS-0.4V(51)			4.98	7.1		
BM14B(0.8)-24DS-0.4V(51)	24	11.5	5.38	7.5	25.5	29.5
BM14B(0.8)-30DS-0.4V(51)			6.58	8.7		
BM14B(0.8)-34DS-0.4V(51)			7.38	9.5		
BM14B(0.8)-40DS-0.4V(51)			8.58	10.7		
BM14B(0.8)-50DS-0.4V(51)			10.58	12.7		
BM14B(0.8)-60DS-0.4V(51)			12.58	14.7		

## ◆ Reel Dimensions

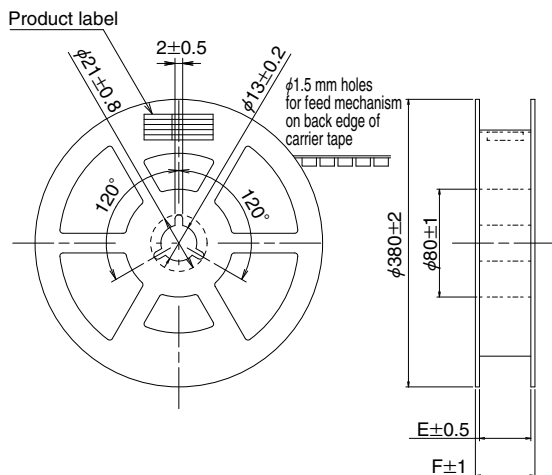

Unit: mm

Part No.	A	B	C	D	E	F
BM14C(0.8)-14DS-0.4V(51)	16	7.5	2.58	4.7	17.5	21.5
BM14C(0.8)-16DS-0.4V(51)			2.98	5.1		
BM14C(0.8)-24DS-0.4V(51)			4.58	6.7		
BM14C(0.8)-26DS-0.4V(51)			4.98	7.1		
BM14C(0.8)-28DS-0.4V(51)	24	11.5	5.38	7.5	25.5	29.5
BM14C(0.8)-34DS-0.4V(51)			6.58	8.7		
BM14C(0.8)-38DS-0.4V(51)			7.38	9.5		
BM14C(0.8)-44DS-0.4V(51)			8.58	10.7		
BM14C(0.8)-54DS-0.4V(51)			10.58	12.7		
BM14C(0.8)-64DS-0.4V(51)			12.58	14.7		

### ● With pick-and-place tape

Unit: mm

Part No.	T	Part No.	T
BM14B(0.8)-10DS-0.4V(52)	1.20	BM14C(0.8)-14DS-0.4V(52)	1.20
BM14B(0.8)-12DS-0.4V(52)	1.38	BM14C(0.8)-16DS-0.4V(52)	1.38
BM14B(0.8)-20DS-0.4V(52)	2.98	BM14C(0.8)-24DS-0.4V(52)	2.98
BM14B(0.8)-22DS-0.4V(52)		BM14C(0.8)-26DS-0.4V(52)	
BM14B(0.8)-24DS-0.4V(52)	3.98	BM14C(0.8)-28DS-0.4V(52)	3.98
BM14B(0.8)-30DS-0.4V(52)		BM14C(0.8)-34DS-0.4V(52)	
BM14B(0.8)-34DS-0.4V(52)		BM14C(0.8)-34DS-0.4V(52)	
BM14B(0.8)-40DS-0.4V(52)		BM14C(0.8)-44DS-0.4V(52)	
BM14B(0.8)-50DS-0.4V(52)		BM14C(0.8)-54DS-0.4V(52)	
BM14B(0.8)-60DS-0.4V(52)		BM14C(0.8)-64DS-0.4V(52)	

Note: The same as the embossed tape packaging without pick-and-place tape except for the T dimension.

### ◆ Embossed Carrier Tape Dimensions: H = 1.3 mm (JIS C 0806 Compliant)

#### ● Receptacle

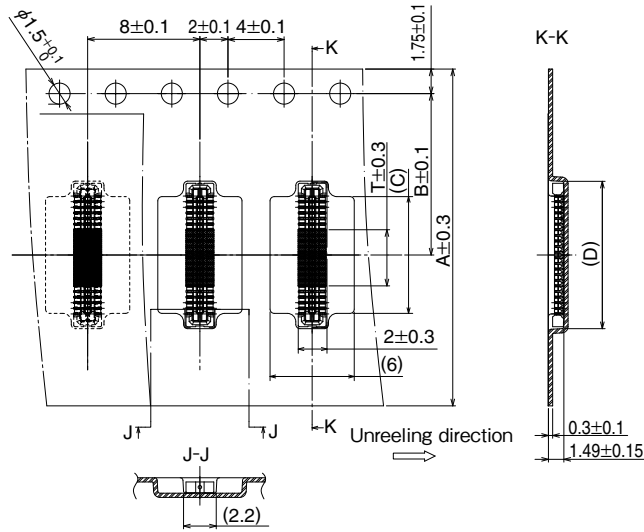

#### ◆ Reel Dimensions

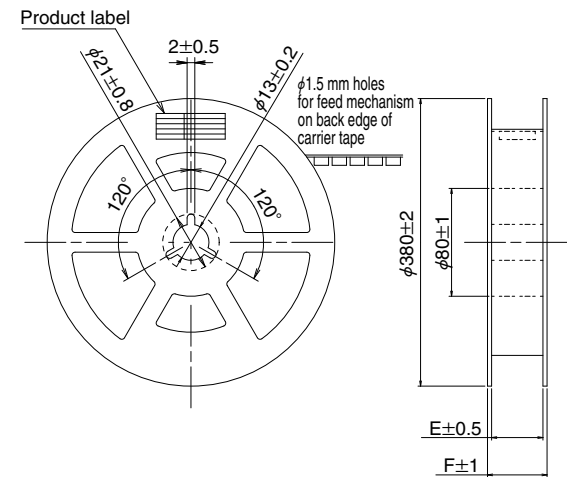

#### ● Without pick-and-place tape

Unit: mm

Part No.	A	B	C	D	E	F
BM14EB(1.3)-40DS-0.4V(51)	24	11.5	8.58	10.7	25.5	29.5
BM14EB(1.3)-50DS-0.4V(51)			10.58	12.7		

Unit: mm

Part No.	A	B	C	D	E	F
BM14EC(1.3)-44DS-0.4V(51)	24	11.5	8.58	10.7	25.5	29.5
BM14EC(1.3)-54DS-0.4V(51)			10.58	12.7		

#### ● With pick-and-place tape

Unit: mm

Part No.	T	Part No.	T
BM14EB(1.3)-40DS-0.4V(52)	3.98	BM14EC(1.3)-44DS-0.4V(52)	3.98
BM14EB(1.3)-50DS-0.4V(52)		BM14EC(1.3)-54DS-0.4V(52)	

Note: The same as the embossed tape packaging without pick-and-place tape except for the T dimension.

### ◆ Embossed Carrier Tape Dimensions: Connector for Conductivity Tests (JIS C 0806 Compliant)

#### ● Receptacle

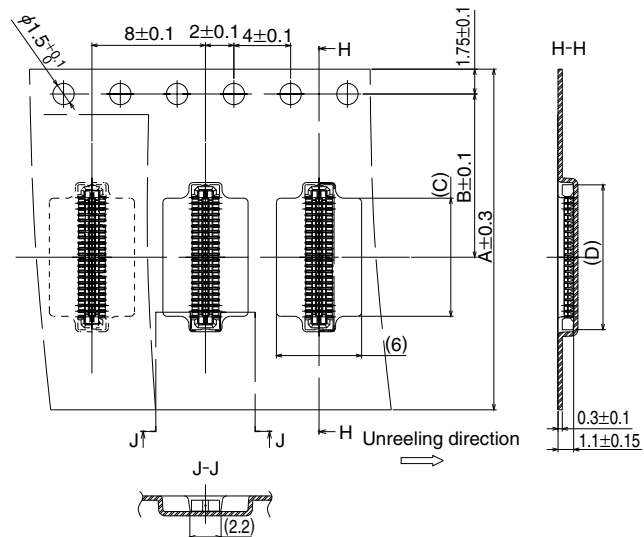

#### ◆ Reel Dimensions

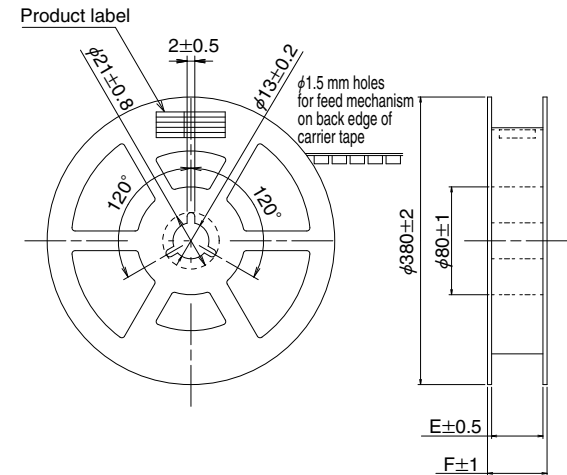

#### ● Without pick-and-place tape

Unit: mm

Part No.	A	B	C	D	E	F
BM14JB-10DS-0.4V(55)	16	7.5	2.58	4.7	17.5	21.5
BM14JB-12DS-0.4V(55)			2.98	5.1		
BM14JB-20DS-0.4V(55)	24	11.5	4.58	6.7	25.5	29.5
BM14JB-22DS-0.4V(55)			4.98	7.1		
BM14JB-24DS-0.4V(55)			5.38	8.5		
BM14JB-30DS-0.4V(55)			6.58	8.7		
BM14JB-34DS-0.4V(55)			7.38	9.5		
BM14JB-40DS-0.4V(55)			8.58	10.7		
BM14JB-50DS-0.4V(55)	10.58	12.7				
BM14JB-60DS-0.4V(55)	12.58	14.7				

Unit: mm

Part No.	A	B	C	D	E	F
BM14JC-14DS-0.4V(55)	16	7.5	2.58	4.7	17.5	21.5
BM14JC-16DS-0.4V(55)			2.98	5.1		
BM14JC-24DS-0.4V(55)	24	11.5	4.58	6.7	25.5	29.5
BM14JC-26DS-0.4V(55)			4.98	7.1		
BM14JC-28DS-0.4V(55)			5.38	8.5		
BM14JC-34DS-0.4V(55)			6.58	8.7		
BM14JC-38DS-0.4V(55)			7.38	9.5		
BM14JC-44DS-0.4V(55)			8.58	10.7		
BM14JC-54DS-0.4V(55)	10.58	12.7				
BM14JC-64DS-0.4V(55)	12.58	14.7				



Header

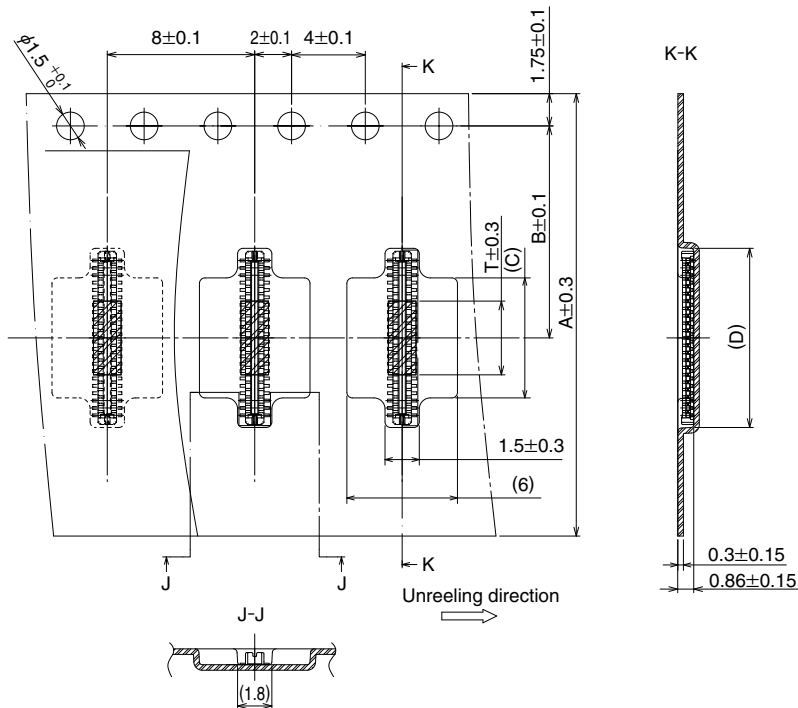

Reel Dimensions

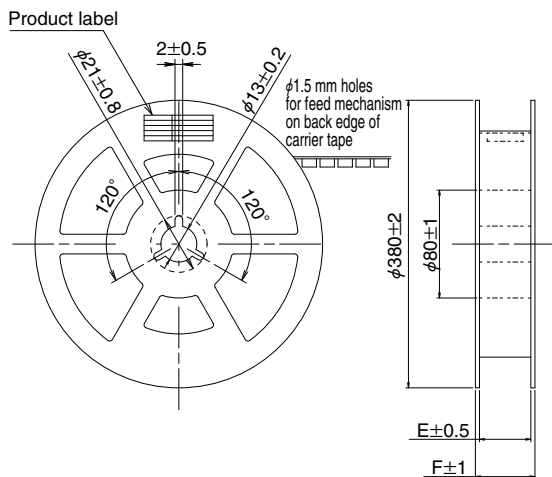

Without pick-and-place tape

Unit: mm

Part No.	A	B	C	D	E	F
BM14B(**)-10DP-0.4V(51)	12	5.5	-	3.68	13.5	17.5
BM14B(**)-12DP-0.4V(51)			-	4.28		
BM14B(**)-20DP-0.4V(51)	16	7.5	2.77	5.88	17.5	21.5
BM14B(**)-22DP-0.4V(51)			3.57	6.28		
BM14B(**)-24DP-0.4V(51)			3.57	6.68		
BM14B(**)-30DP-0.4V(51)	24	11.5	4.77	7.88	25.5	29.5
BM14B(**)-34DP-0.4V(51)			5.57	8.68		
BM14B(**)-40DP-0.4V(51)			6.77	9.88		
BM14B(**)-50DP-0.4V(51)			8.77	11.88		
BM14B(**)-60DP-0.4V(51)			10.77	13.88		

Unit: mm

Part No.	A	B	C	D	E	F
BM14C(**)-14DP-0.4V(51)	12	5.5	-	3.68	13.5	17.5
BM14C(**)-16DP-0.4V(51)			-	4.28		
BM14C(**)-24DP-0.4V(51)	16	7.5	2.77	5.88	17.5	21.5
BM14C(**)-26DP-0.4V(51)			3.57	6.28		
BM14C(**)-28DP-0.4V(51)			3.57	6.68		
BM14C(**)-34DP-0.4V(51)	24	11.5	4.77	7.88	25.5	29.5
BM14C(**)-38DP-0.4V(51)			5.57	8.68		
BM14C(**)-44DP-0.4V(51)			6.77	9.88		
BM14C(**)-54DP-0.4V(51)			8.77	11.88		
BM14C(**)-64DP-0.4V(51)			10.77	13.88		

With pick-and-place tape

Unit: mm

Part No.	T	Part No.	T
BM14B(**)-10DP-0.4V(52)	-	BM14C(**)-14DP-0.4V(52)	-
BM14B(**)-12DP-0.4V(52)	-	BM14C(**)-16DP-0.4V(52)	-
BM14B(**)-20DP-0.4V(52)	1.9	BM14C(**)-24DP-0.4V(52)	1.9
BM14B(**)-22DP-0.4V(52)		BM14C(**)-26DP-0.4V(52)	
BM14B(**)-24DP-0.4V(52)	3.0	BM14C(**)-28DP-0.4V(52)	3.0
BM14B(**)-30DP-0.4V(52)		BM14C(**)-34DP-0.4V(52)	
BM14B(**)-34DP-0.4V(52)		BM14C(**)-38DP-0.4V(52)	
BM14B(**)-40DP-0.4V(52)		BM14C(**)-44DP-0.4V(52)	
BM14B(**)-50DP-0.4V(52)		BM14C(**)-54DP-0.4V(52)	
BM14B(**)-60DP-0.4V(52)		BM14C(**)-64DP-0.4V(52)	

Note: The same as the embossed tape packaging without pick-and-place tape except for the T dimension.

## ◆ Usage Recommendations

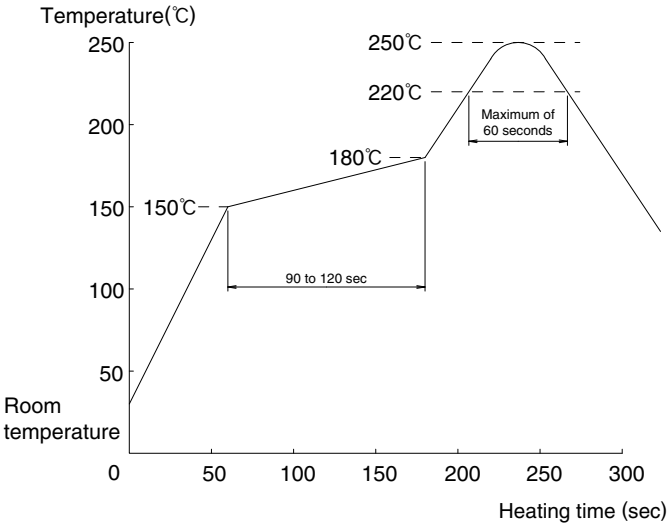
<p>1. Recommended solder profile</p>	 <p><b>Temperature(°C)</b></p> <p>250 200 150 100 50 Room temperature</p> <p>0 50 100 150 200 250 300</p> <p>Heating time (sec)</p> <p>150°C 180°C 220°C 250°C</p> <p>90 to 120 sec Maximum of 60 seconds</p> <p><b>【Conditions】</b></p> <ol style="list-style-type: none"> <li>1. Peak temperature: 250°C</li> <li>2. Heating part: 220°C or more, 60 seconds or less</li> <li>3. Preheating part: 150 to 180°C, 90 to 120 seconds</li> <li>4. Cycle: Maximum of 2 cycles</li> </ol> <p>Note 1 : The temperatures indicated are the surface temperatures of a printed circuit board at the points of contact with the terminals.</p>
<p>2. Recommended manual soldering</p>	<p>Manual soldering: 340 ±10°C for 3 seconds</p>
<p>3. Recommended screen thickness and open area ratio (Pattern area ratio)</p>	<p>H = 0.8 mm for DP and DS Thickness: 0.1 mm Open area ratio: DP 0.1 mm 95%, DS 0.1 mm 95%</p> <p>H = 1.3 mm for DP and DS Thickness: 0.1 mm Open area ratio: DP 0.1 mm 95%, DS 0.1 mm 95%</p>
<p>4. Board warpage</p>	<p>Maximum of 0.02 mm at the connector center, with both ends of the connector as reference points</p>
<p>5. Cleaning conditions</p>	<p>Cleaning is not recommended for this connector. Cleaning agents can deteriorate the mechanical operation and the environmental resistance of this connector.</p>
<p>6. Precautions</p>	<ul style="list-style-type: none"> <li>■ Do not mate or unmate these connectors until they are mounted, failure to follow this precaution can lead to deformation or damage to these connectors.</li> <li>■ Provide another form of support to the PCB, this connector was not designed to be the main form of support.</li> <li>■ When mating/un-mating, do not twist or lift by the corners. It may cause damage or deformation.</li> <li>■ Do not apply excessive amounts of flux as it may cause excess solder and flux wicking.</li> <li>■ There may be a slight variance in the color of the molding between production lots, this variance will not affect the performance of the connector.</li> <li>■ Refer to the next page for the handling precautions when mating and unmating the connectors.</li> <li>■ If the connector becomes disconnected due to impact, a fall or a counterforce to the FPC, it may be necessary to hold the connector in place with an addition to the device's case or other cushioning material to hold the connector in place.</li> </ul>

## ◆ Handling precautions when mating

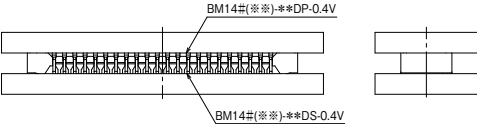
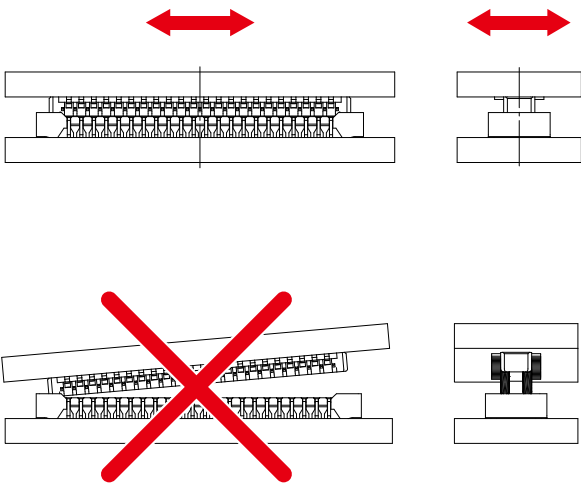
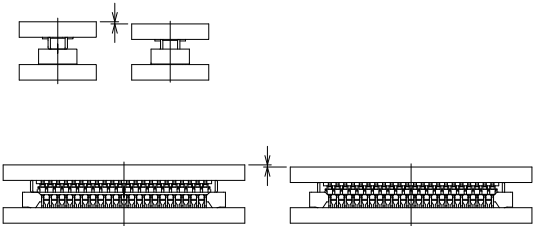
	
	<p>Prior to mating, locate the guide ribs and align the header. Do not apply excessive force during the mating process as it may damage the contacts.</p>
	<p>Once aligned, the position of the connector will drop down slightly. Make sure that the connector is square to the other side, then press it down until it is fully mated.</p>

## ◆ Handling precautions for unmating

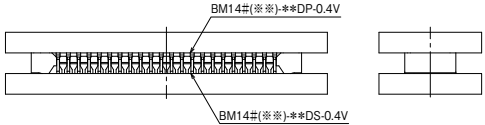
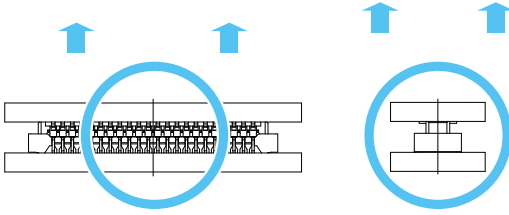
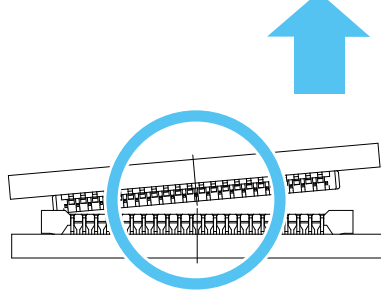
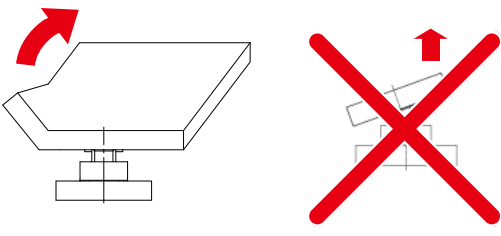
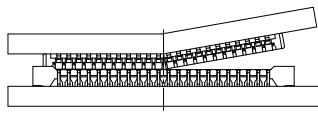
	
	<p>To unmate this connector, lift evenly across the header. Make sure that each side of the connector stays parallel to the other.</p>
	<p>If circumstances prevent the connectors from staying parallel to each other, then one side may be lifted as shown in the diagram. This method is only approved if the connector is mounted onto an extremely rigid circuit board. If the board were to warp during this process it may result in damage to the connector or its solder joints.</p>
	<p>Do not try to disconnect these connectors by pulling on one side or a single corner, or to unmate it when it hasn't been securely mounted onto a rigid FPC. These actions may lead to deformities and ultimately a damaged connector. Prior to the mounting of these connectors we recommend that you check the rigidity of your FPC to ensure that it meets the standards needed to support these connectors.</p>
	<p>If the FPC is not strong enough, there is a risk that the connector could break as illustrated in the diagram to the left. Proper testing and checks must be made with the customer's FPC to determine if the FPC stiffener has sufficient rigidity. Evaluative reports of FPC rigidity and other items are available.</p>



**HIROSE ELECTRIC CO.,LTD.**

2-6-3,Nakagawa Chuoh,Tsuzuki-Ku,Yokohama-Shi 224-8540,JAPAN

TEL: +81-45-620-3526 Fax: +81-45-591-3726

<http://www.hirose.com>

<http://www.hirose-connectors.com>