

SPECIFICATION

G21 GSM Hercules Gen.II Penta Band Cellular Antenna

- Part No. : **G21.B.301111**
- Product Name : Hercules Gen.II Penta Band Cellular Antenna
Screw-mount (Permanent mount)
- Features : GSM/GPRS/CDMA/EVDO/UMTS/HSPA/WCDMA
850/900/1800/1900/2100MHz
Low profile - Height 29mm, diameter 49mm
Heavy duty screw mount
UV and Vandal resistant PC housing
IP67 & IP69K
3M Cable RG174 Standard
SMA(M) Connector Standard
Cable and Connector are Customizable
ROHS Compliant



1. INTRODUCTION

The G21 (Generation II) Hercules is a high performance, steel thread-mount, Penta-band cellular antenna for external use on vehicles and outdoor assets worldwide. Omni-directional high gain across all bands ensures constant reception and transmission. The durable UV resistant PC housing is resistant to vandalism and direct attack.

With IP67 and IP69K waterproof rating, the G21 can be screw mounted on vehicles and outdoor/indoor assets via its extra thick thread. The antenna has a compact dimension at only 28.5mm in height and 49mm in diameter. The enclosure is designed to not catch on tree-branches.

Taoglas recommend a minimum cable length of 300mm when used on a ground plane to achieve an efficiency of greater than 30%.

This antenna can be mounted on metal structures. The G21 is an ideal solution for cellular external applications where it can operate with or without the ground plane.

2. SPECIFICATION

ELECTRICAL-On 30x30cm Ground Plane						
Standard	AMPS	GSM	DCS	PCS	3G	
Band (MHz)	850	900	1800	1900	2100	
Frequency (MHz)	824-896	880-960	1710-1880	1850-1990	1920 -2170	
Return Loss (dB)						
Cable length (meter)	0.3	-6.0	-5.2	-6.1	-6.2	-5.8
	1.0	-7.8	-8.7	-11.4	-15.3	-13.7
	2.0	-8.1	-9.3	-16.5	-20.3	-19.5
	3.0	-11.0	-12.4	-17.5	-18.3	-18.1
	5.0	-11.8	-13.6	-17.6	-17.8	-17.8
Efficiency (%)						
Cable length (meter)	0.3	51.1	41.4	38.0	46.5	33.3
	1.0	39.4	40.2	42.2	43.4	31.3
	2.0	24.3	27.5	28.4	28.2	29.6
	3.0	24.6	27.6	22.0	23.8	24.6
	5.0	17.1	16.4	15.7	15.0	12.0
Peak Gain (dBi)						
Cable length (meter)	0.3	2.0	1.5	4.0	4.3	4.2
	1.0	1.7	2.7	1.8	1.9	1.8
	2.0	1.4	2.1	0.8	-0.3	-0.7
	3.0	1.0	1.0	-0.9	-1.1	-1.1
	5.0	-0.8	-0.3	-4.2	-3.9	-4.2
Polarization	Linear					
Impedance	50 ohms					
Max Input Power	10 watts					
VSWR	<3.5:1					

ELECTRICAL-On 60x60cm Ground Plane						
Standard	AMPS	GSM	DCS	PCS	3G	
Return Loss (dB)						
Cable length (meter)	0.3	-6.0	-5.6	-8.8	-8.5	-7.8
	1.0	-7.8	-8.2	-13.6	-13.8	-16.3
	2.0	-8.9	-11.1	-16.7	-19.6	-19.5
	3.0	-11.0	-13.6	-17.8	-18.3	-18.6
	5.0	-12.3	-14.8	-19.1	-19.1	-18.2
Efficiency (%)						
Cable length (meter)	0.3	31.0	30.3	47.1	43.6	41.6
	1.0	28.0	29.3	39.2	33.5	31.2
	2.0	26.3	28.5	28.8	29.6	30.7
	3.0	19.2	18.6	21.3	22.1	25.2
	5.0	11.4	12.8	13.7	11.6	12.3
Peak Gain (dBi)						
Cable length (meter)	0.3	2.1	2.3	3.1	3.0	2.8
	1.0	1.0	0.6	1.9	1.6	0.9
	2.0	0.6	0.2	0.8	-0.2	-0.8
	3.0	-0.5	0.1	0.2	-0.1	-1.1
	5.0	-2.3	-2.2	-2.9	-3.4	-3.9
ELECTRICAL-FREE SPACE						
Return Loss (dB)						
Cable length (meter)	0.3	-6.2	-5.3	-5.8	-6.4	-5.6
	1.0	-8.1	-8.3	-10.9	-15.8	-13.2
	2.0	-8.5	-12.3	-15.8	-17.6	-17.2
	3.0	-11.6	-12.9	-16.9	-17.9	-18.3
	5.0	-11.8	-15.6	-18.6	-18.4	-18.8
Efficiency (%)						
Cable length (meter)	0.3	53.2	51.3	42.8	43.6	46.7
	1.0	24.3	32.6	32.8	40.2	27.8
	2.0	24.1	25.8	27.8	31.2	26.2
	3.0	23.3	24.2	23.4	22.8	23.6
	5.0	13.6	20.8	12.1	11.8	10.3
Peak Gain (dBi)						
Cable length (meter)	0.3	0.4	0.9	2.4	2.5	2.2
	1.0	0.2	0.2	0.9	0.9	1.8
	2.0	-1.7	-1.3	1.1	-0.4	-1.5
	3.0	-1.8	-1.1	-1.2	-1.8	-1.9
	5.0	-3.3	-2.3	-4.1	-4.6	-4.7

MECHANICAL	
Dimensions	Height = 29 mm and Diameter = 49mm
Cable	3M RG174 – Fully Customizable
Connector	SMA-Male – Fully Customizable
Casing	UV Resistant PC
Base and Thread	Nickel plated steel
Thread Diameter	18 mm
Weather proof gasket	CR4305 foam with 3M9448B double-side adhesive
Sealant	Rubber Stopper
ENVIRONMENTAL	
Protection	IP67 & IP69K
Corrosion	5% NaCl for 48hrs - Nickel plated steel base and thread
Temperature Range	-40°C to +85°C
Thermal Shock	100 cycles -40°C to +85°C
Humidity	Non-condensing 65°C 95% RH
Shock (Drop Test)	1m drop on concrete 6 axes
Cable Pull	8 Kgf
Recommended Mounting Torque	24.5N·m
Maximum Mounting Torque	29.5N·m
Weight	150g

3. TEST SETUP

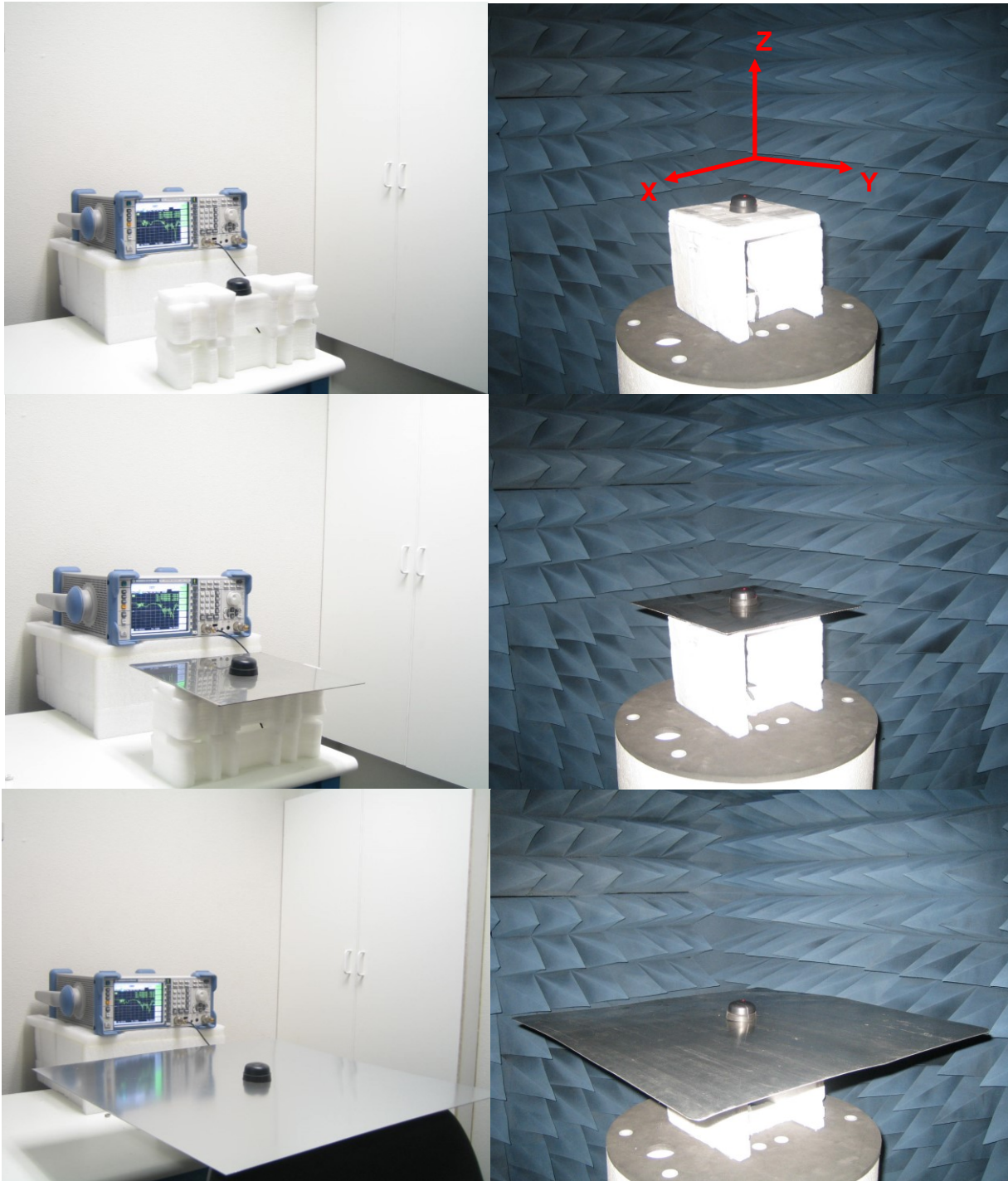

Figure 1. G21 Antenna test set up in free space, 30x30 cm metal plate, and 60x60 cm metal plate, R&SZVL6 VNA (left) and R&S4100 CTIA 3D Chamber (Right).

4. ANTENNA PARAMETERS

4.1 Return Loss

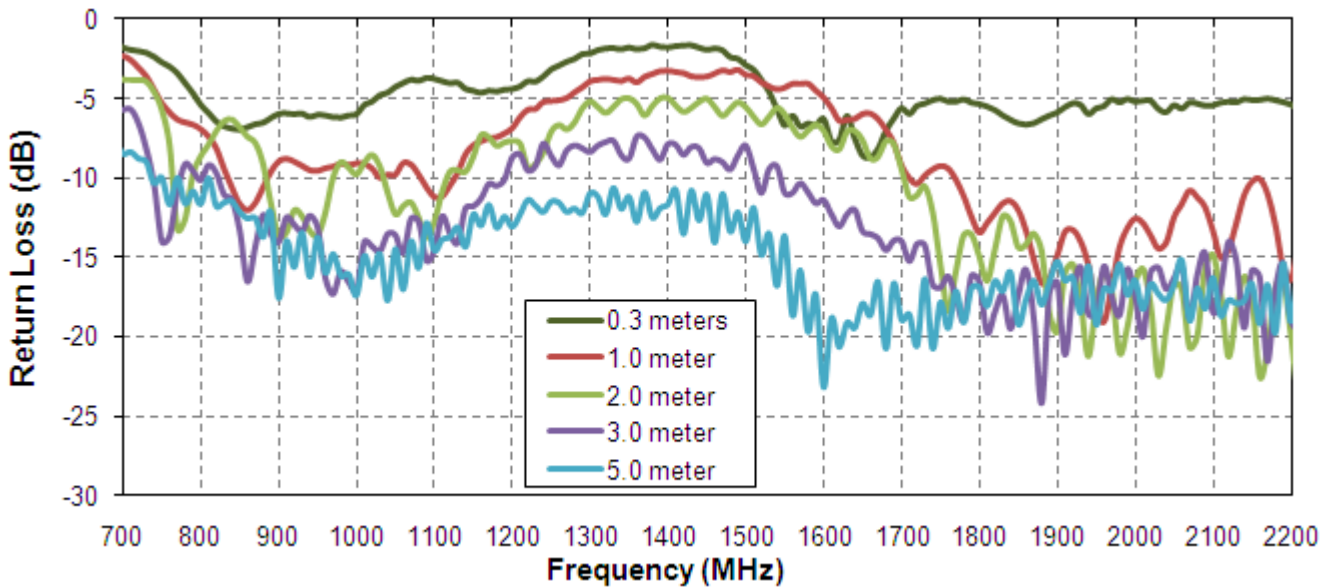

Figure 2. Return Loss of G21 Hercules antenna in free space.

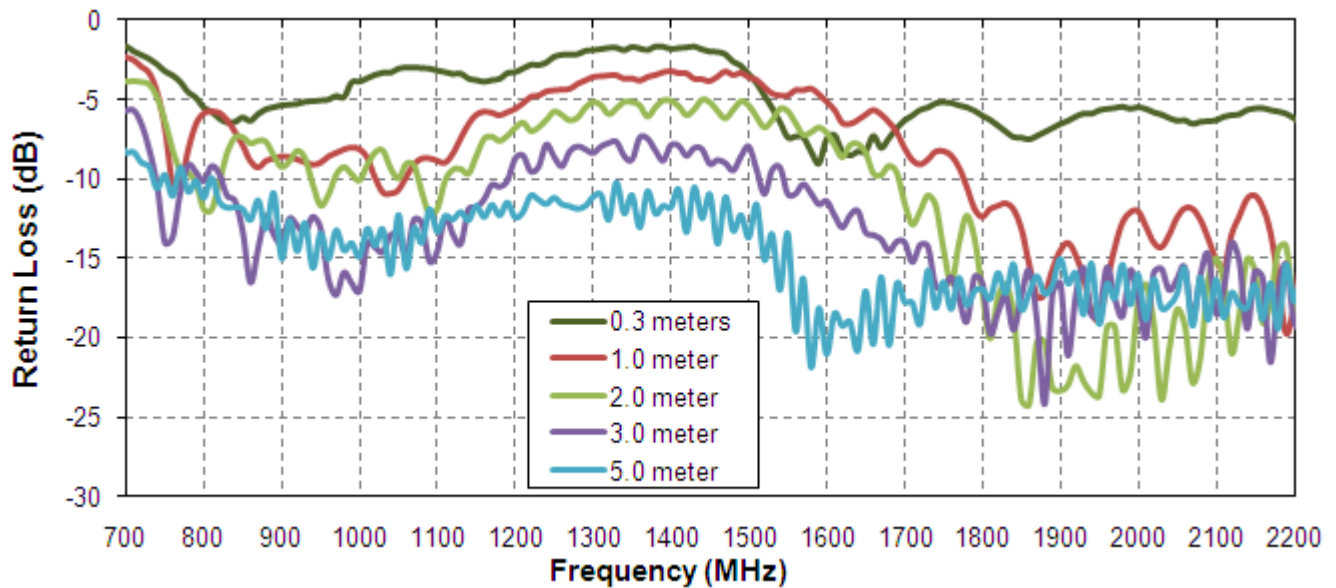

Figure 3. Return loss of G21 Hercules antenna on 30 cm metal plate.

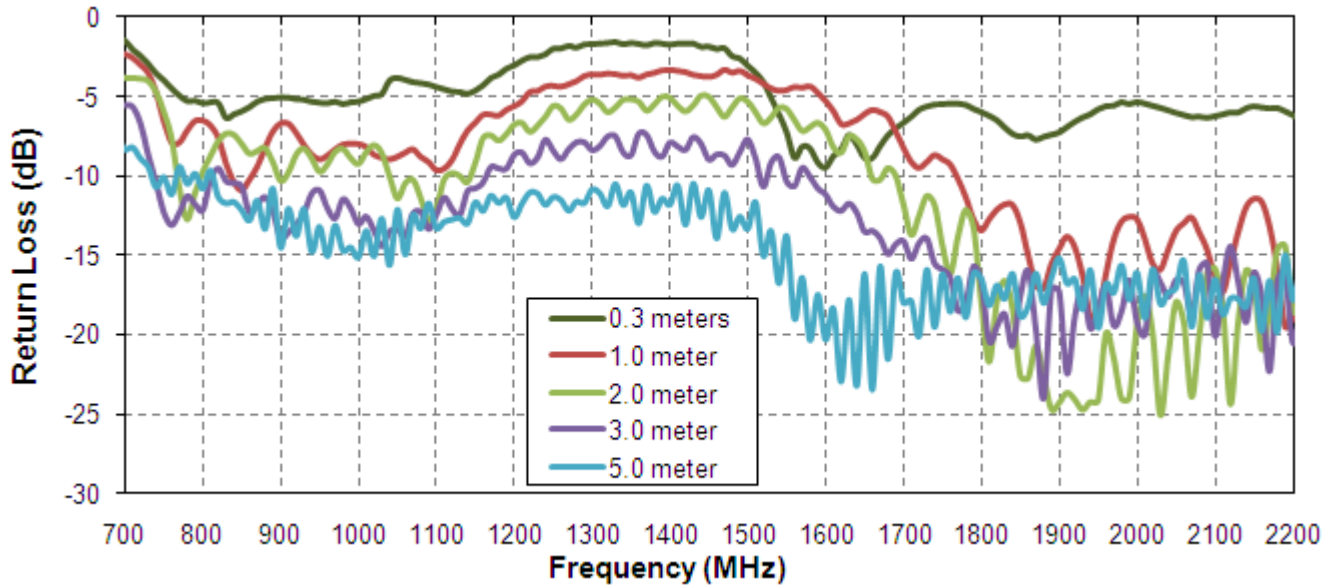

Figure 4. Return loss of G21 Hercules antenna on 60 cm metal plate.

4.2 Efficiency

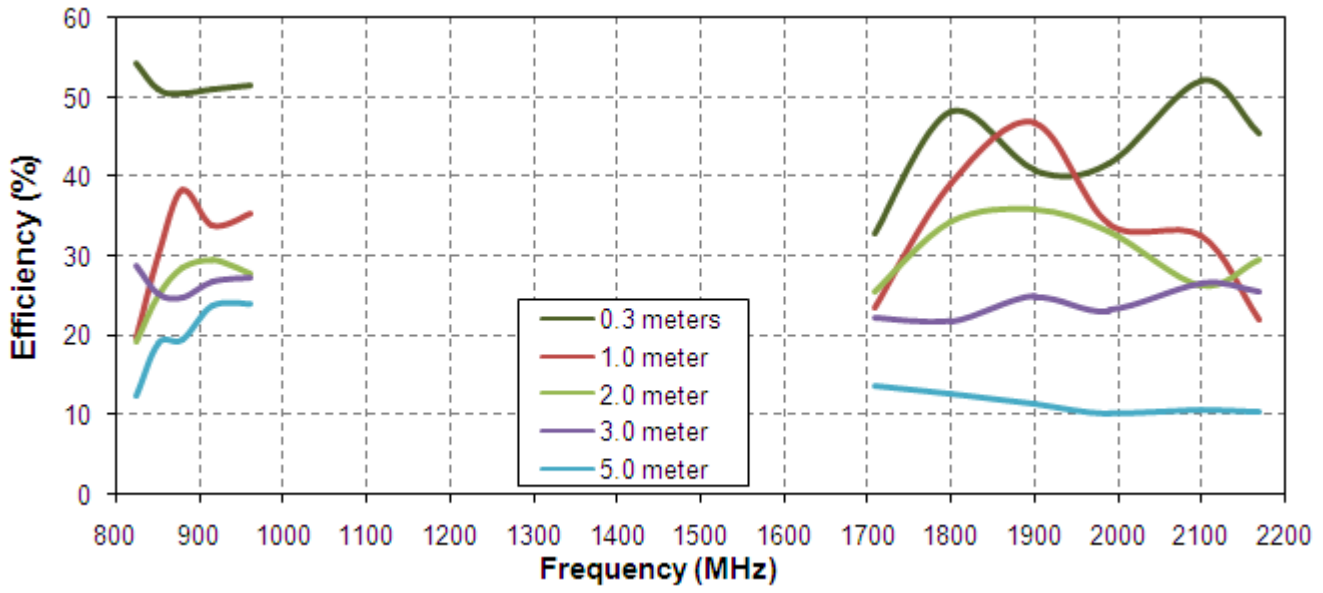

Figure 5. Efficiency of G21 Hercules antenna in free space.

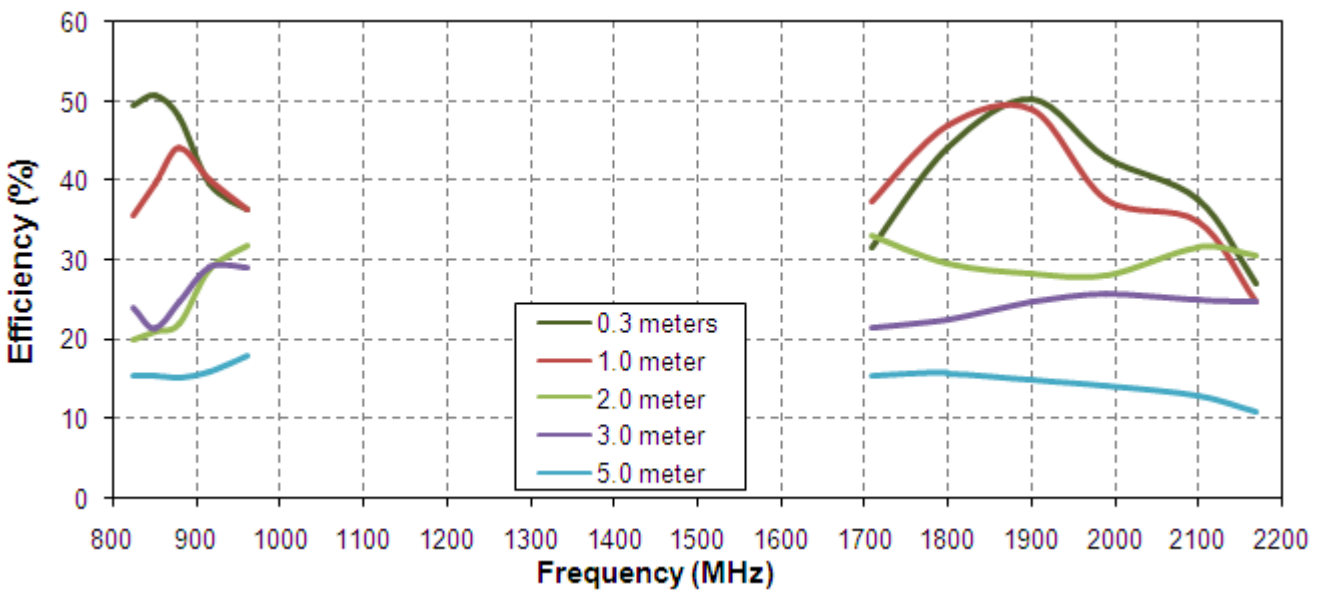

Figure 6. Efficiency of G21 Hercules antenna on 30 cm metal plate.

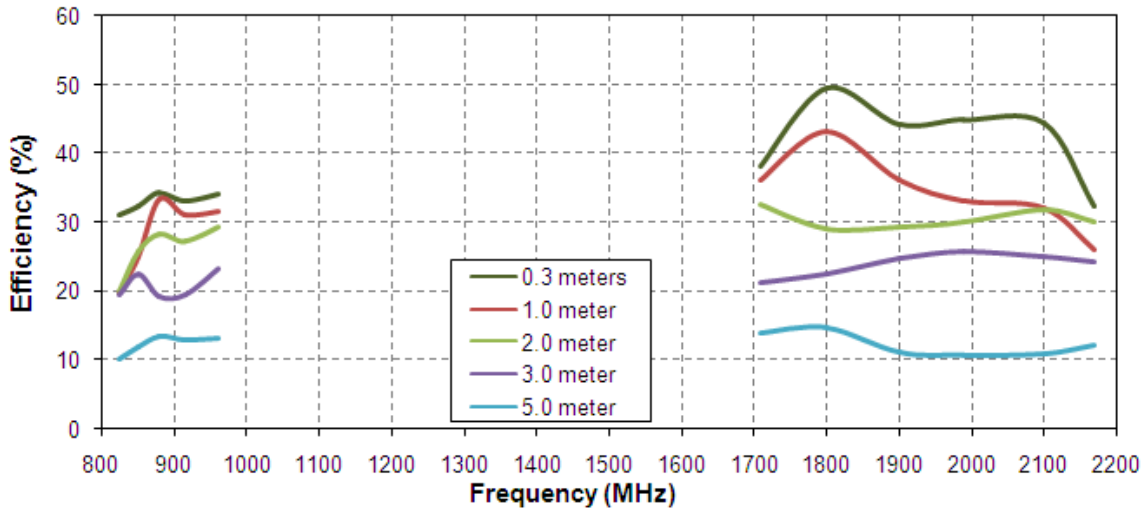

Figure 7. Efficiency of G21 Hercules antenna on 60 cm metal plate.

4.3 Peak Gain

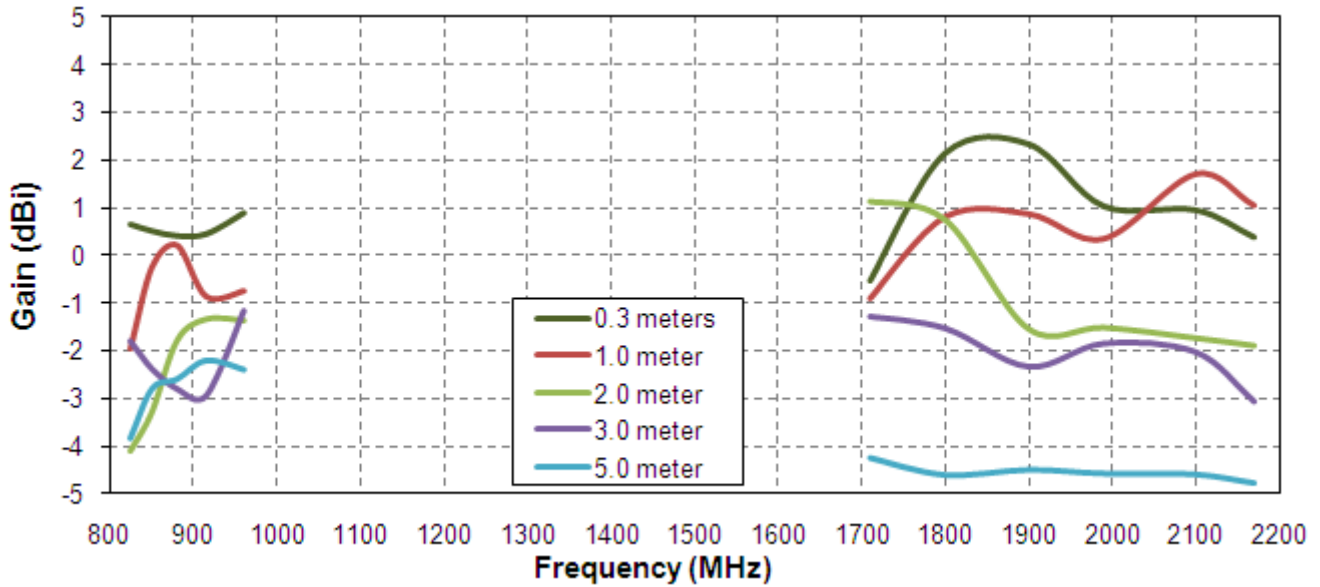

Figure 8. Peak Gain of G21 Hercules antenna in free space.

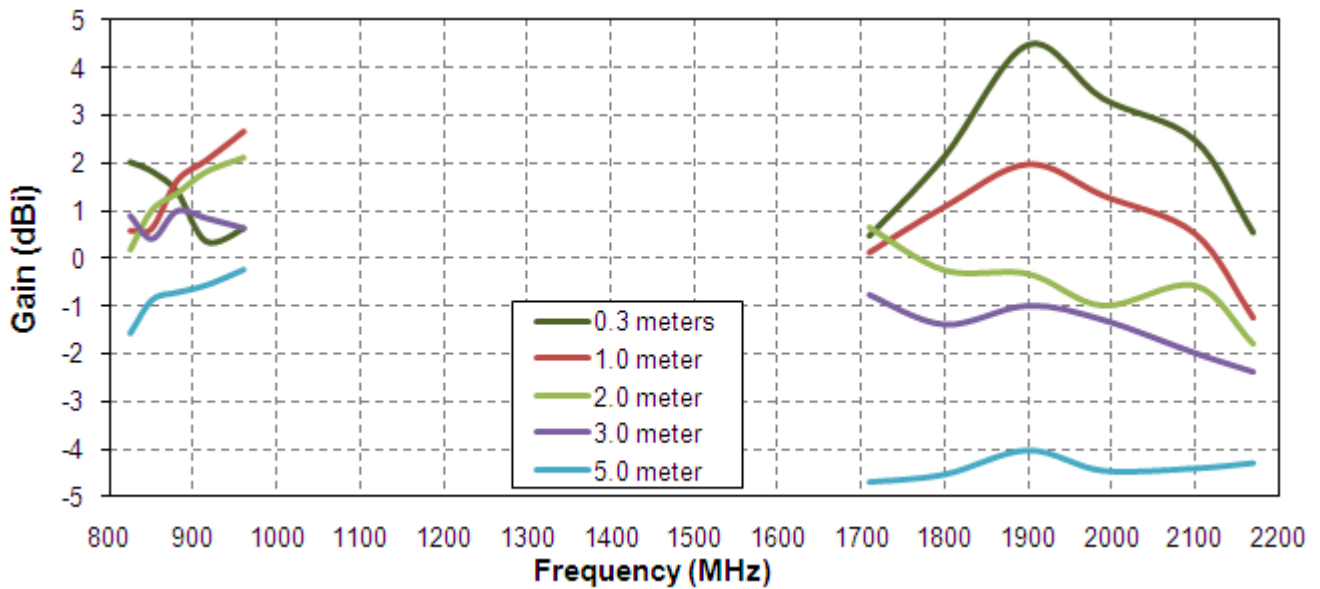

Figure 9. Peak Gain of G21 Hercules antenna on 30 cm metal plate.

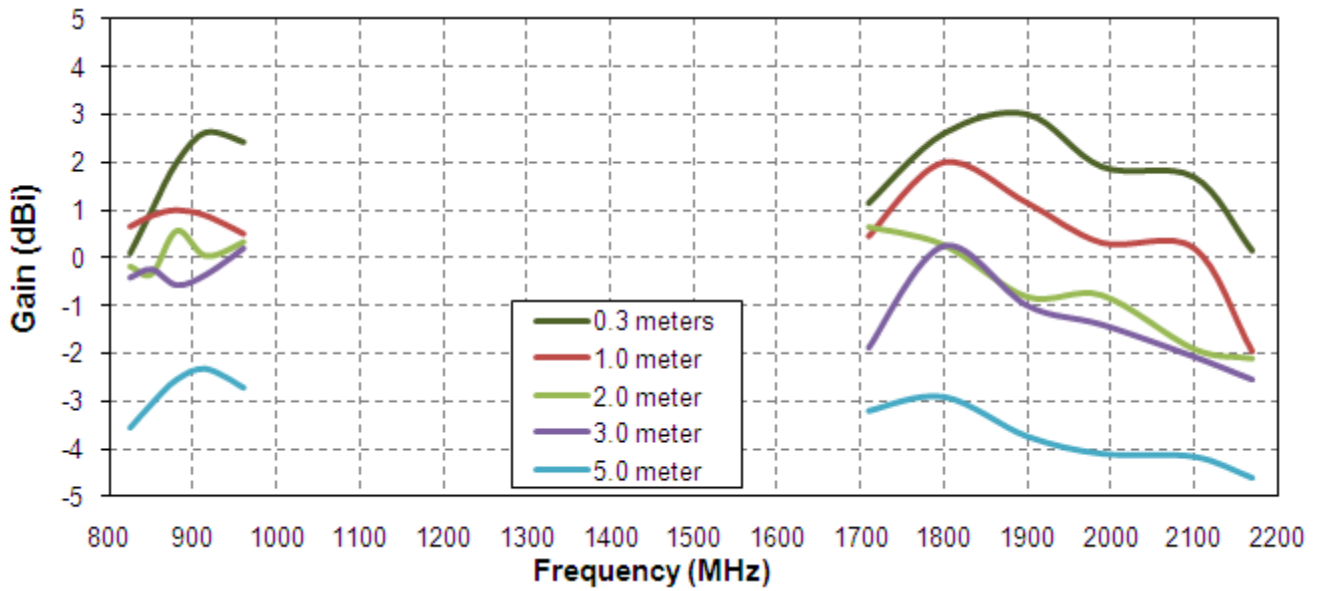

Figure 10. Peak Gain of G21 Hercules antenna on 60 cm metal plate.

5. Radiation Patterns

5.1 Radiation Patterns (Free Space)

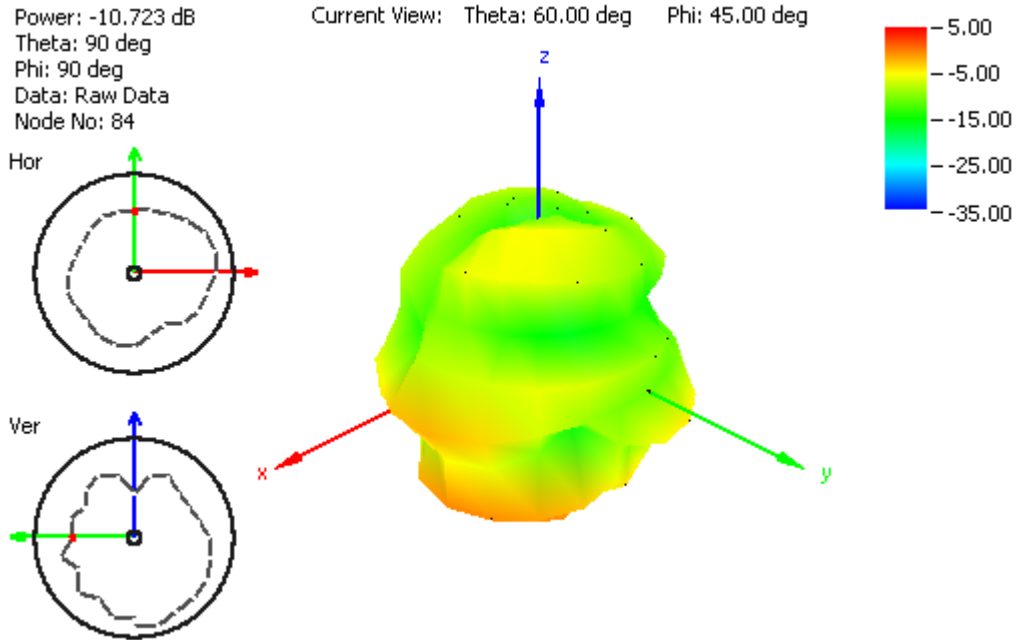

Figure 11. Radiation pattern at 849 MHz, Figure 1 as reference (dB), with 2m RG174 cable and free space

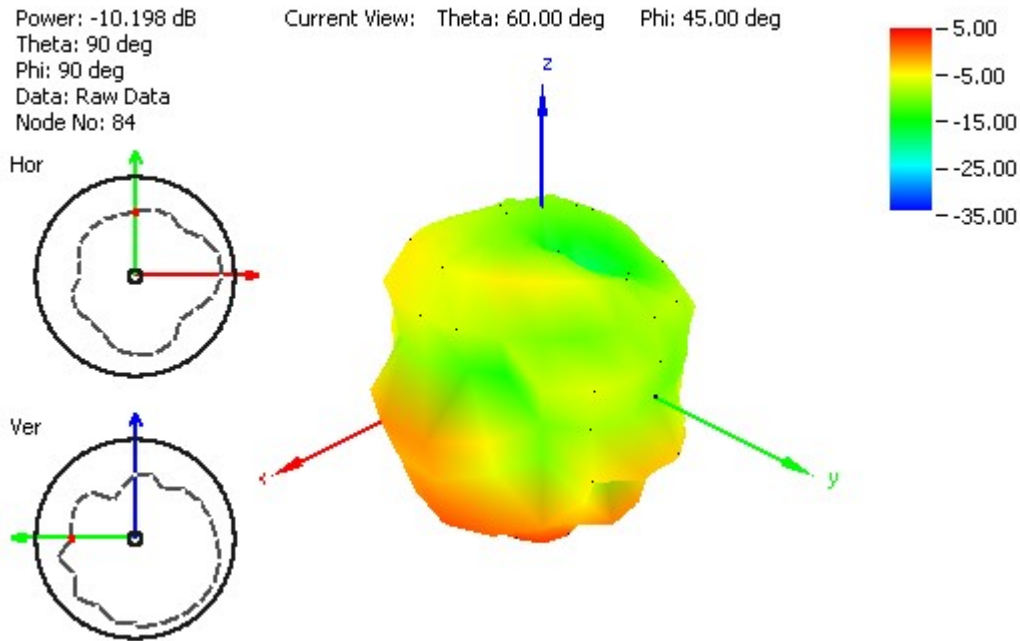

Figure 12. Radiation pattern at 915 MHz, Figure 1 as reference (dB), with 2m RG174 cable and free space.

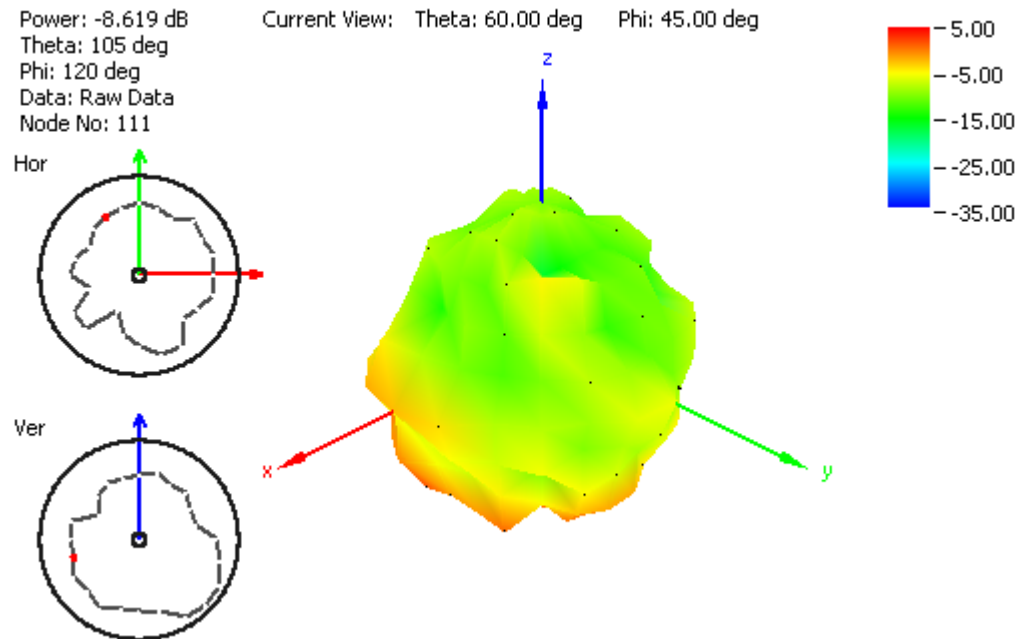

Figure 13. Radiation pattern at 1805 MHz, Figure 1 as reference (dB), with 2m RG174 cable and free space.

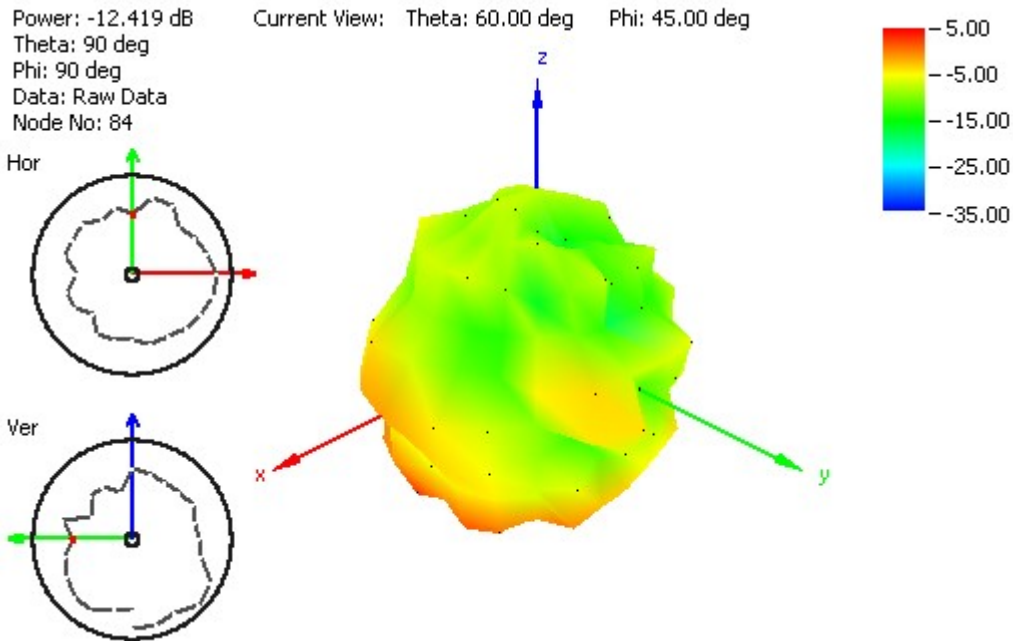

Figure 14. Radiation pattern at 1910 MHz, Figure 1 as reference (dB), with 2m RG174 cable and free space.

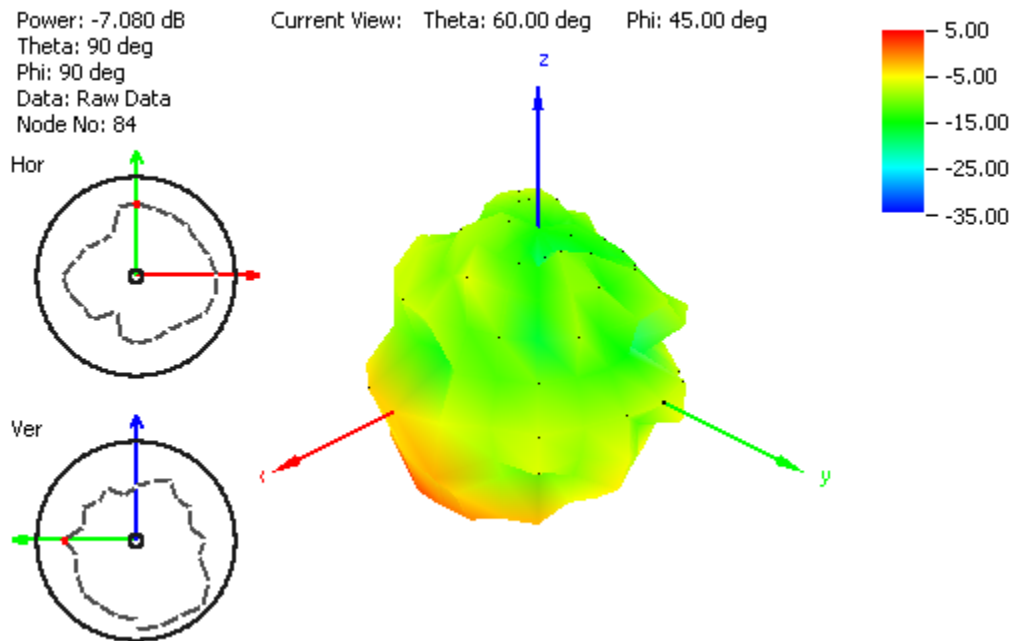

Figure 15. Radiation pattern at 2110 MHz, Figure 1 as reference (dB), with 2m RG174 cable and free space.

5.2 Radiation Patterns (30*30cm Ground Plane)

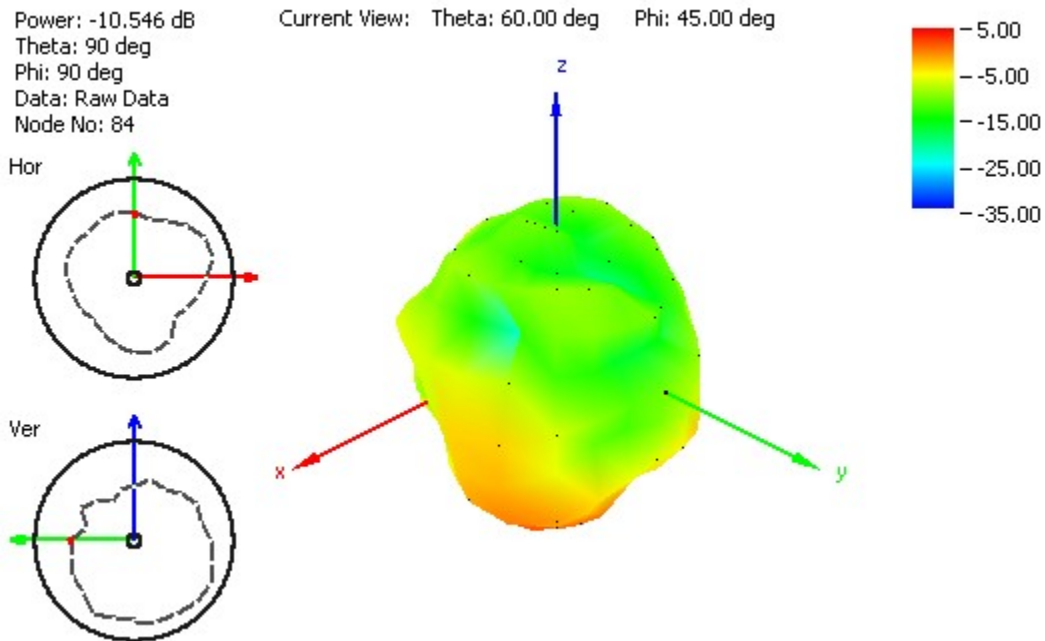

Figure 16. Radiation pattern at 849 MHz, Figure 1 as reference (dB), with 2m RG174 cable and 30x30 cm metal plate.

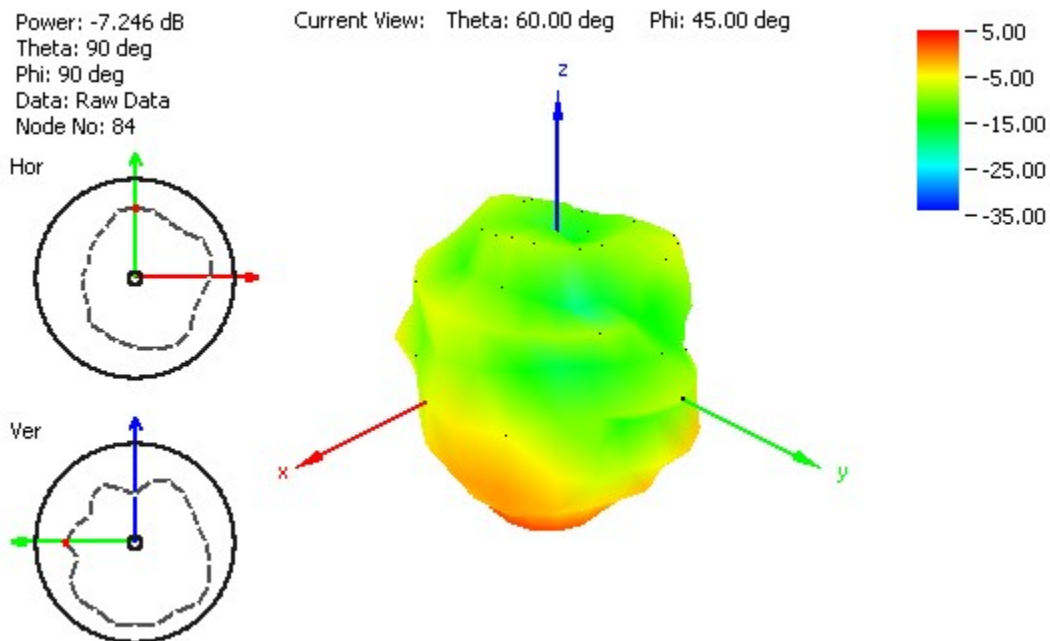

Figure 17. Radiation pattern at 915 MHz, Figure 1 as reference (dB), with 2m RG174 cable and 30x30 cm metal plate.

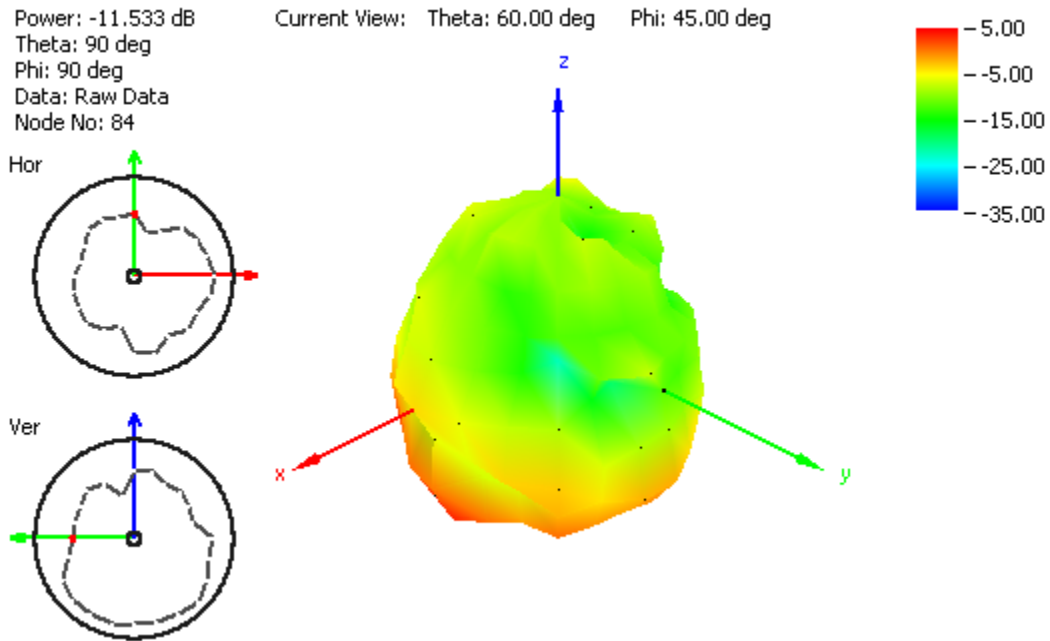

Figure 18. Radiation pattern at 1805 MHz, Figure 1 as reference (dB), with 2m RG174 cable and 30x30 cm metal plate.

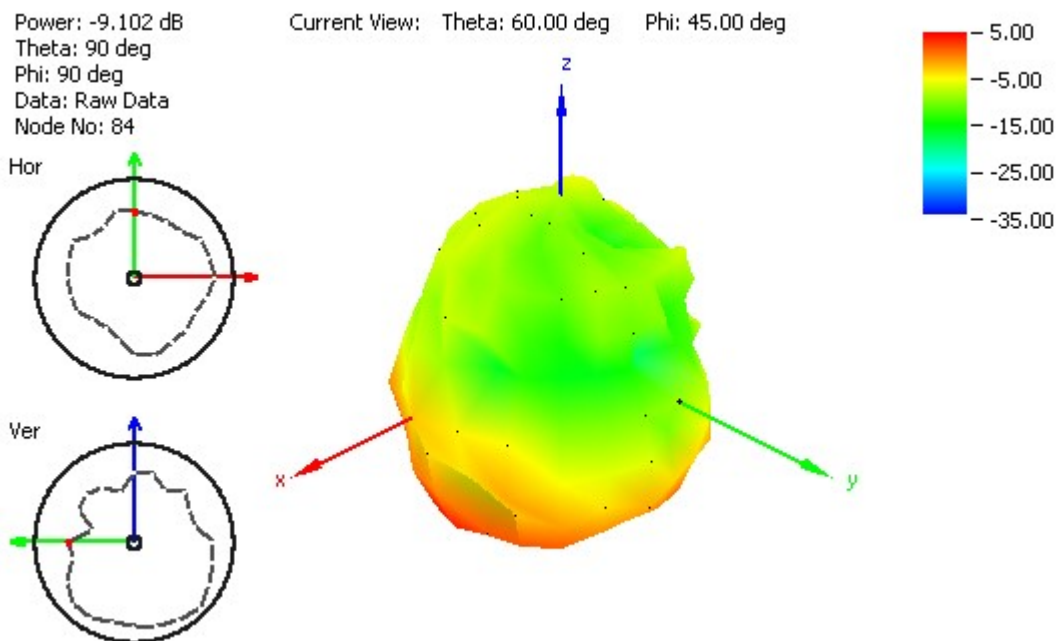

Figure 19. Radiation pattern at 1910 MHz, Figure 1 as reference (dB), with 2m RG174 cable and 30x30 cm metal plate.

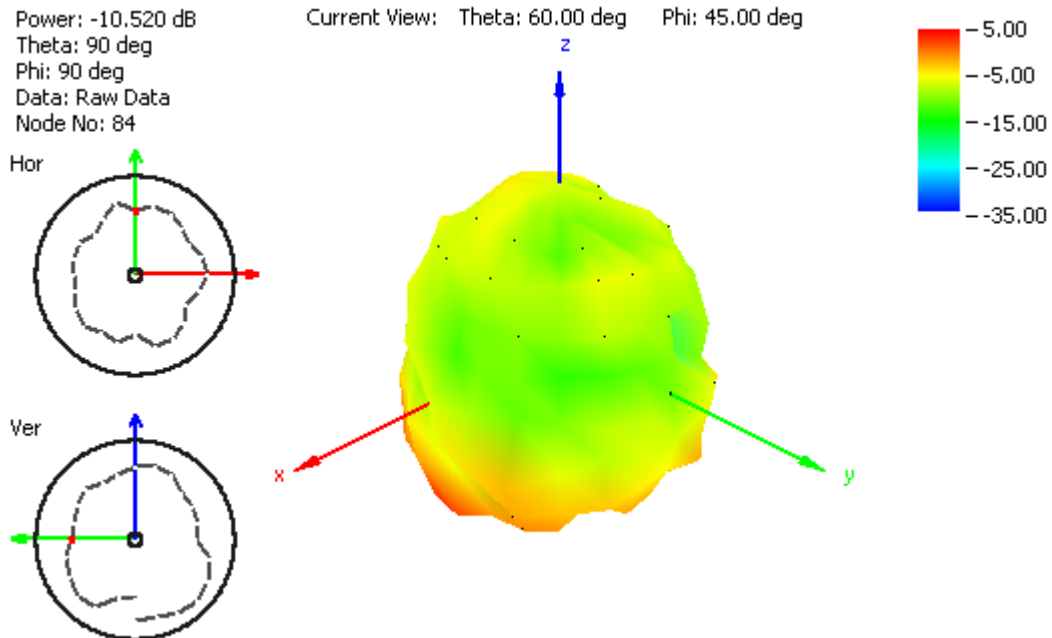

Figure 20. Radiation pattern at 2110 MHz, Figure 1 as reference (dB), with 2m RG174 cable and 30x30 cm metal plate.

5.3 Radiation Patterns (60*60cm Ground Plane)

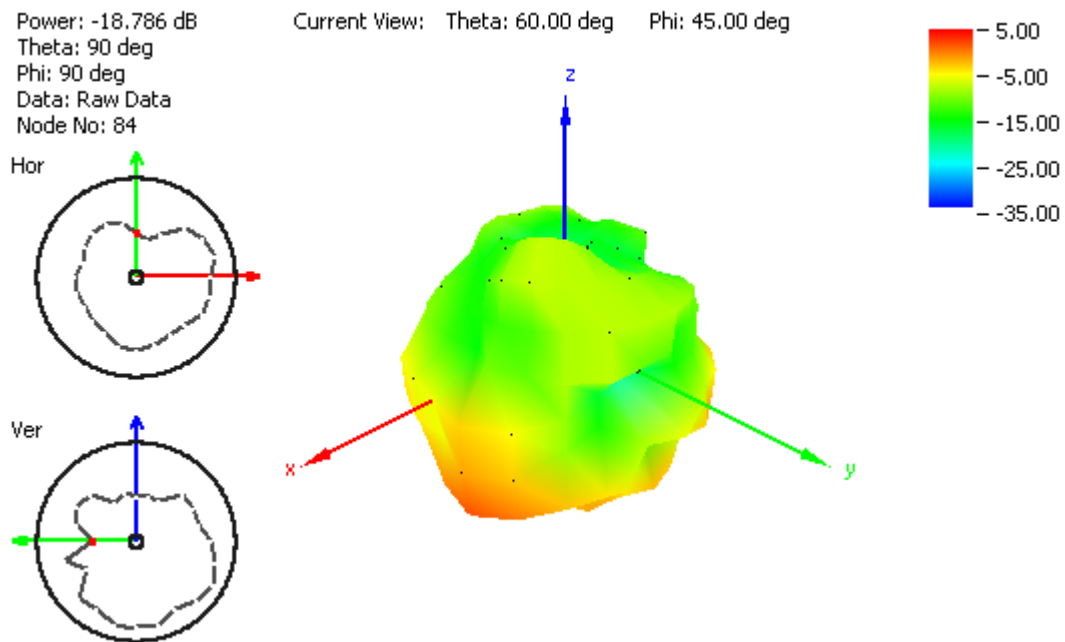

Figure 21. Radiation pattern at 849 MHz, Figure 1 as reference (dB), with 2m RG174 cable and 60x60 cm metal plate.

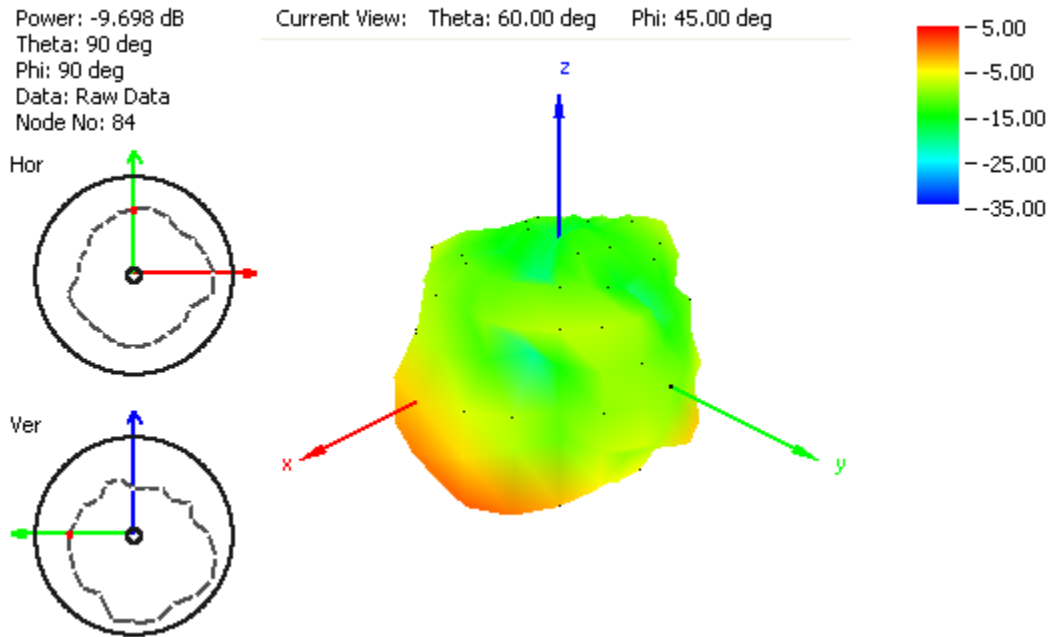

Figure 22. Radiation pattern at 915 MHz, Figure 1 as reference (dB), with 2m RG174 cable and 60x60 cm metal plate.

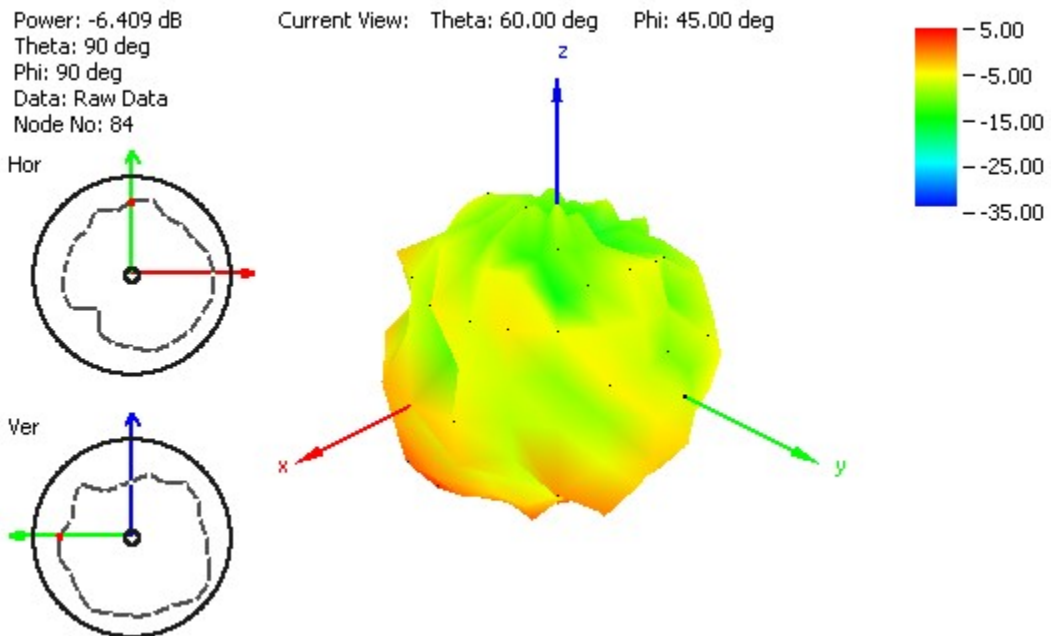

Figure 23. Radiation pattern at 1805 MHz, Figure 1 as reference (dB), with 2m RG174 cable and 60x60 cm metal plate.

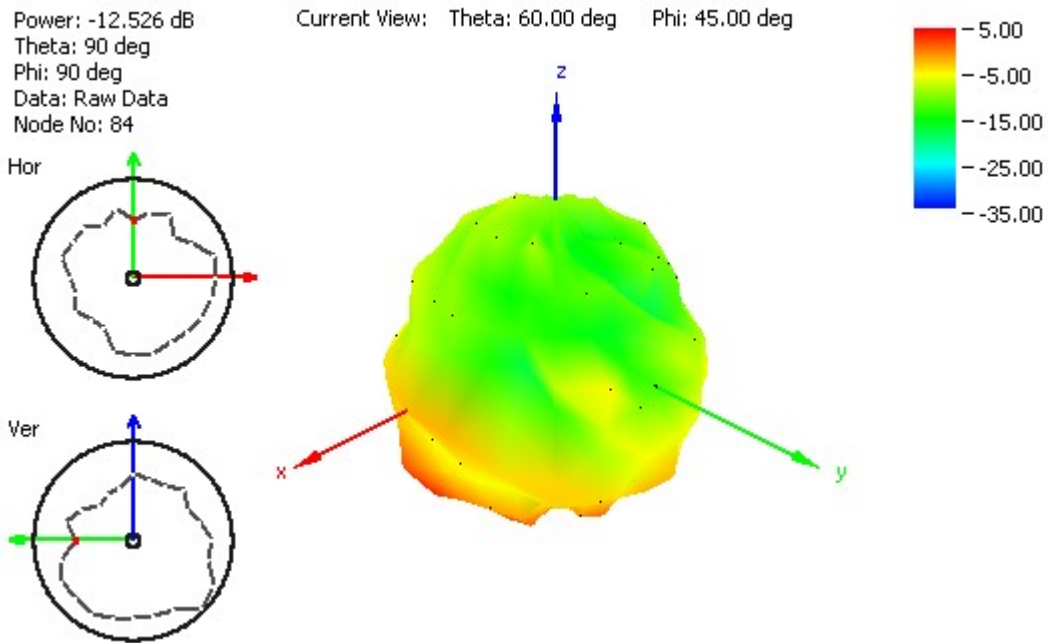

Figure 24. Radiation pattern at 1910 MHz, Figure 1 as reference (dB), with 2m RG174 cable and 60x60 cm metal plate.

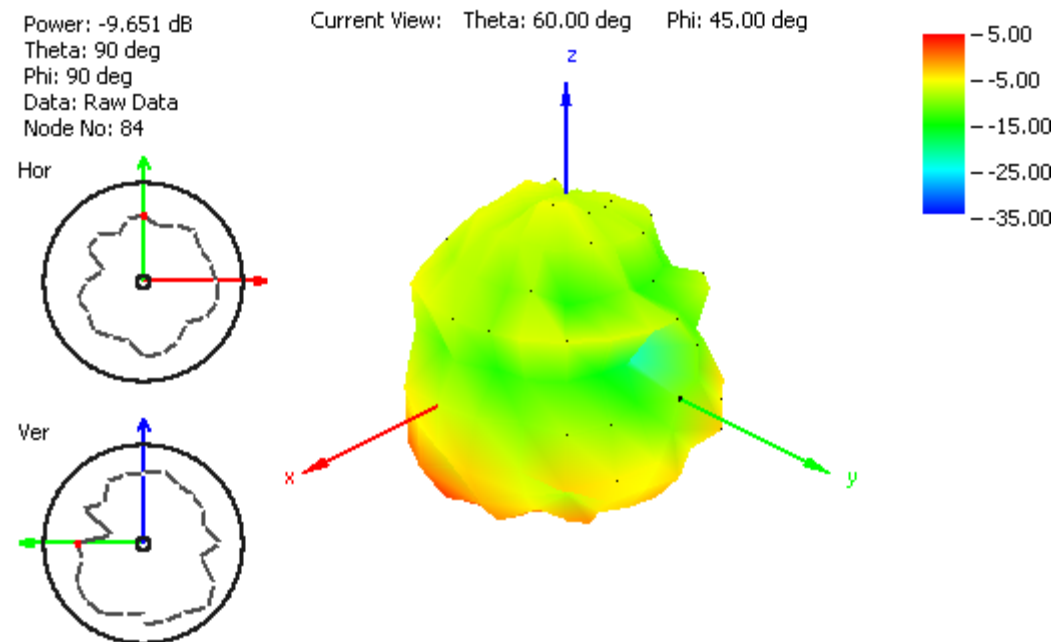
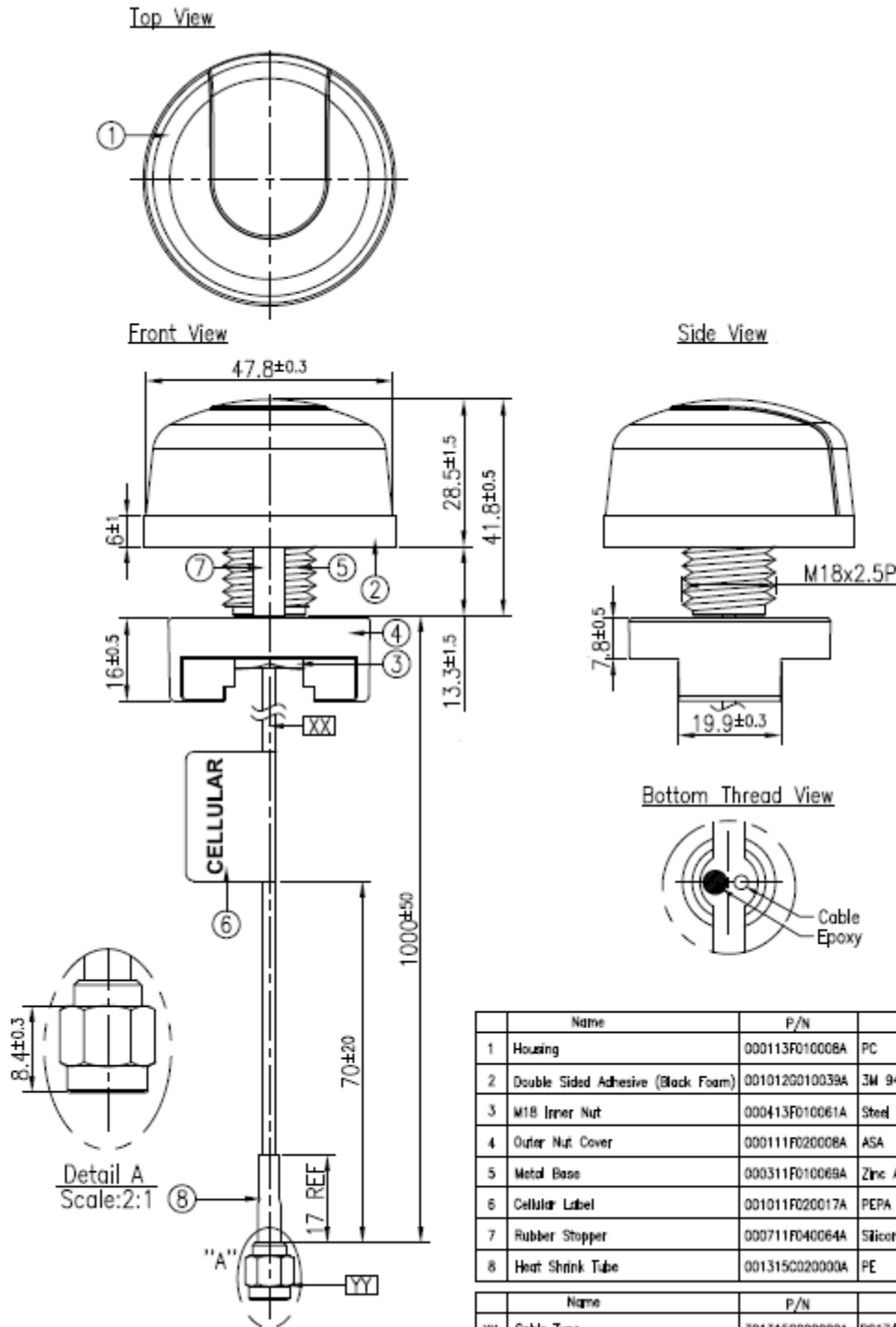

Figure 25. Radiation pattern at 2110 MHz, Figure 1 as reference (dB), with 2m RG174 cable and 60x60 cm metal plate.



6. MECHANICAL DRAWINGS



Name	P/N	Material	Finish	QTY
1 Housing	000113F010008A	PC	Black	1
2 Double Sided Adhesive (Black Foam)	001012G010039A	3M 9448BK+CR4305	White Liner	1
3 M18 Inner Nut	000413F010061A	Steel Carbon	Zn Plated	1
4 Outer Nut Cover	000111F020008A	ASA	Black	1
5 Metal Base	000311F010069A	Zinc Alloy	Ni Plated	1
6 Cellular Label	001011F020017A	PEPA	Blue	1
7 Rubber Stopper	000711F040064A	Silicone Rubber	Black	1
8 Heat Shrink Tube	001315C020000A	PE	Black	1

Name	P/N	Spec	Finish	QTY
XX Cable Type	301315C000000A	RG174	Black	1
YY Connector Type	200212G000013A	SMA(M)5T	Au Plated	1

7. Installation

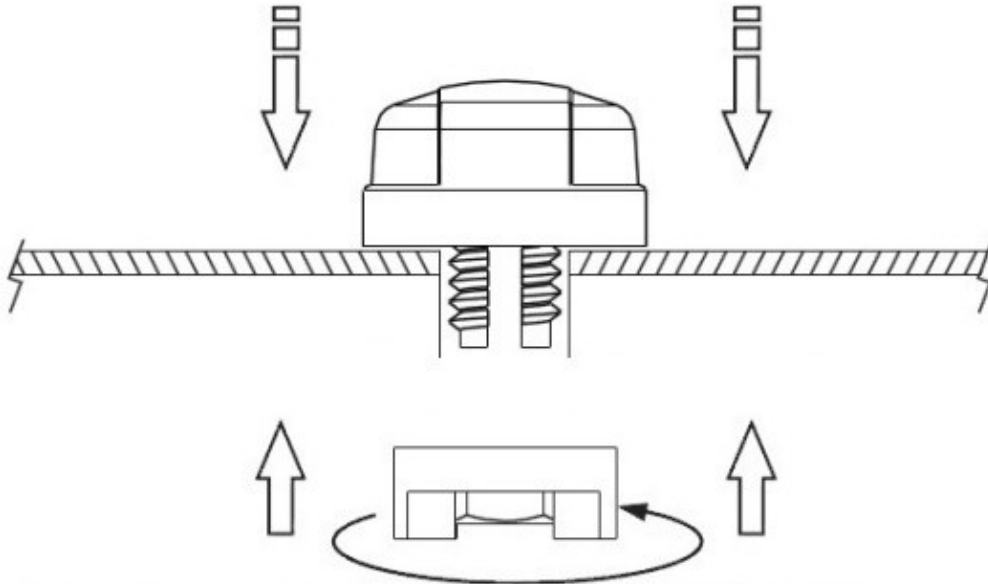

Recommended torque for Mounting is 24.5N·m
Maximum torque for mounting is 29.4N·m



8. Packaging

1 G21.B.301111 per PE bag
 Small bag dimensions - 300*100mm
 10 pcs per big bag
 Big bag dimensions 280*450mm

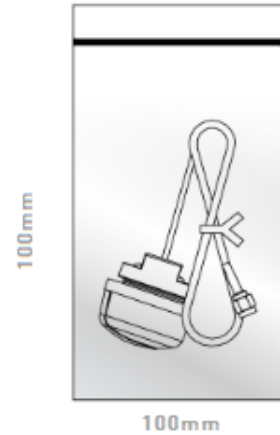

100 PE bags per carton
 Carton Dimensions - 320*250*230mm

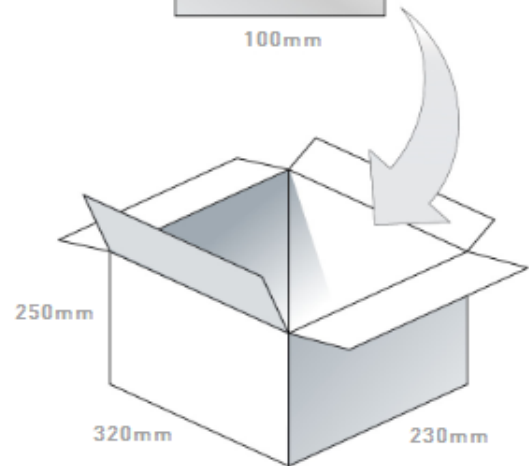

Pallet Dimensions 1200*1200*1500mm
 60 Cartons per pallet
 12 Cartons per layer
 5 Layers

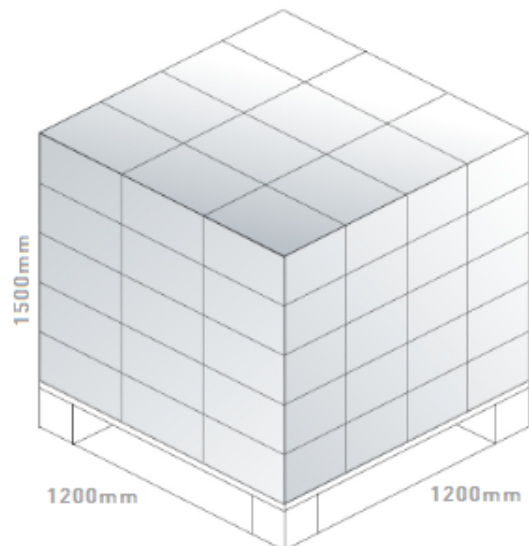



Taoglas makes no warranties based on the accuracy or completeness of the contents of this document and reserves the right to make changes to specifications and product descriptions at any time without notice. Taoglas reserves all rights to this document and the information contained herein.

Reproduction, use or disclosure to third parties without express permission is strictly prohibited.

Copyright © Taoglas Ltd.