

IQS360EV02 Evaluation Kit User Guide

IQ Switch® - ProxSense® Series

Table of Contents

1	Introduction.....	1
2	Driver Board and IQS360 IC.....	1
3	Touch demo board	3
4	Snap demo board.....	5
5	Reference Designs.....	6

1 Introduction

This user guide describes the operation of the IQS360EV02 Evaluation Kit. The EV-Kit consists of 3 parts, the driver board, the touch demo board and the snap demo board. The quick start guide is also included. To visualise raw data from the EV-Kit, the driver board can be interfaced to any personal computer with USB support, and IQS360 software Graphical User Interface (GUI). The purpose of the IQS360EV02 EV-Kit is to help application and development engineers in evaluating the IQS360's 12 channel projected-capacitive proximity and touch sensors. A picture of the evaluation kit is shown below.

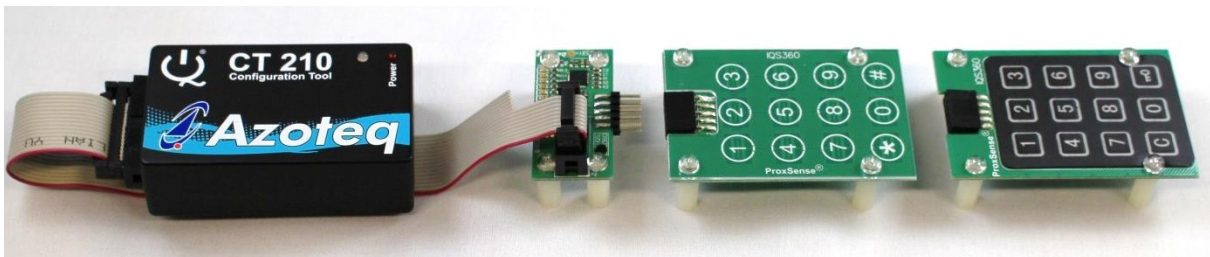

Figure 1.1 CT210 (sold separately) (left), Driver board (middle left), Touch Demo board (middle right) and Snap Demo board (right)

This user guide will help a user to fully use and understand the technology in this evaluation kit. The driver board will be described, followed by the touch demo board and the snap demo board. This will be shown in conjunction with an IQS360 GUI (Graphical User Interface) to simplify explanations.

2 Driver Board and IQS360 IC

The IQS360 IC (Integrated Circuit) is located on the driver board. The IQS360 can be used in projected capacitive mode with up to 12 channels.

The IQS360 has a configurable PWM controller which is used to drive LEDs and can be used as a general output pin. Figure 2.1 and Figure 2.2 shows the working of the PWM controller. Figure 2.1 shows the switched on LEDs on the driver board. This is achieved by running the IQS360 GUI through following the next steps.

- Run IQS360 Application
- Read and Close the Hints & Tips menu
- Click the Start button
- Click the Touch/Snap Demo icon in the demos tab.
- Set the Mode to “Const” (Constant) and “CMP” (Compare) value to 31.
- Click the Send button.

The LEDs on the connection board should turn on as shown below.

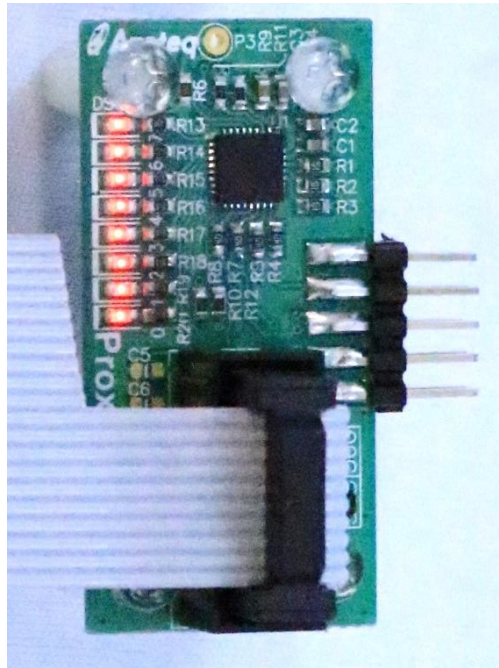

Figure 2.1 Connection board with PWM LEDs switched on

The GUI should look similar to the screenshot below with the relevant settings highlighted.

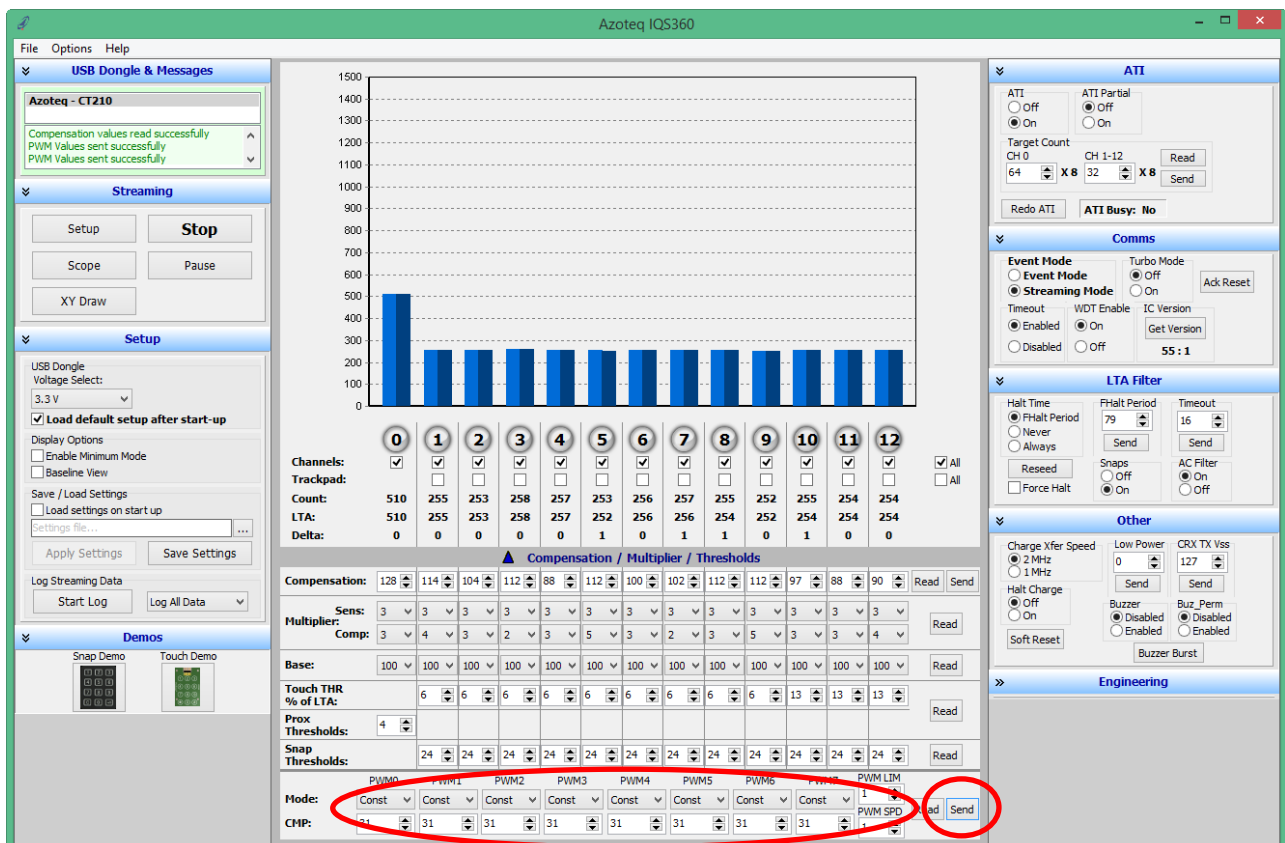

Figure 2.2 Switch PWM LEDs on with IQS360 GUI

The driver board has 2 10-way headers, 1 box header for communicating with a microcontroller, such as a CT210, and a straight DIL header for connecting to the sense electrodes. The pin outs for the headers are numbered in the figure below and each pins description is given in Table 1. This is given as users may wish to connect their own sensing electrodes to the IQS360.

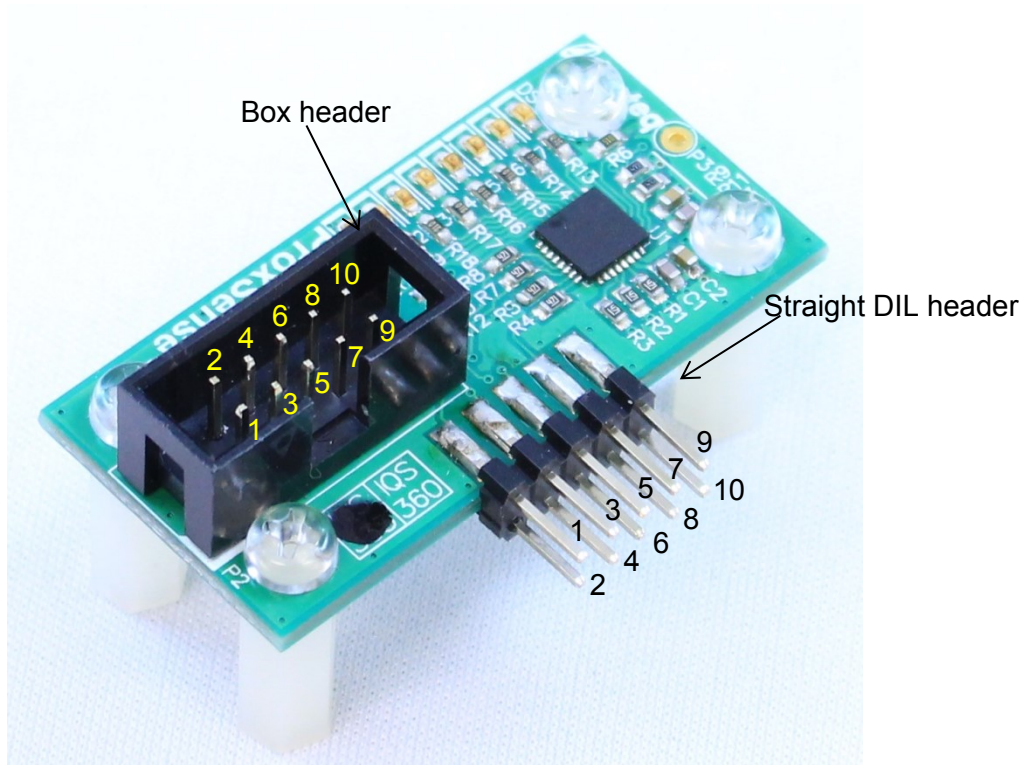

Figure 2.3 Connection board pin outs

Table 1 Connection board pin out description

Header 1 Box header		Header 2 Straight DIL header	
Pin number – Description		Pin number – Description	
1 – Ground	2 – No connect	1 – CTRX0/RX0	2 – CTRX4/TX1
3 – VDDHI	4 – No connect	3 – CTRX1/RX1	4 – CTRX5/TX2
5 – No connect	6 – No connect	5 – CTRX2/RX2	6 – CTRX6
7 – I ² C Data	8 – No connect	7 – CTRX3/TX0	8 – No connect
9 – I ² C Clock	10 – Ready	9 – No connect	10 – Ground

3 Touch demo board

The IQS360EV02 Kit comes with 2 module boards: the touch demo and the snap demo boards. First we look at the working of the touch demo board. Always remember to click the **Stop** button before removing or connecting a module board. When the wanted board is connected click the **Start** button to continue evaluating. This Stop and Start is needed for the software to ensure that no errors occur.

To evaluate the touch demo board, connect the touch demo board to the driver board as shown in the figure below.



Figure 3.1 Touch demo board plugged into driver board

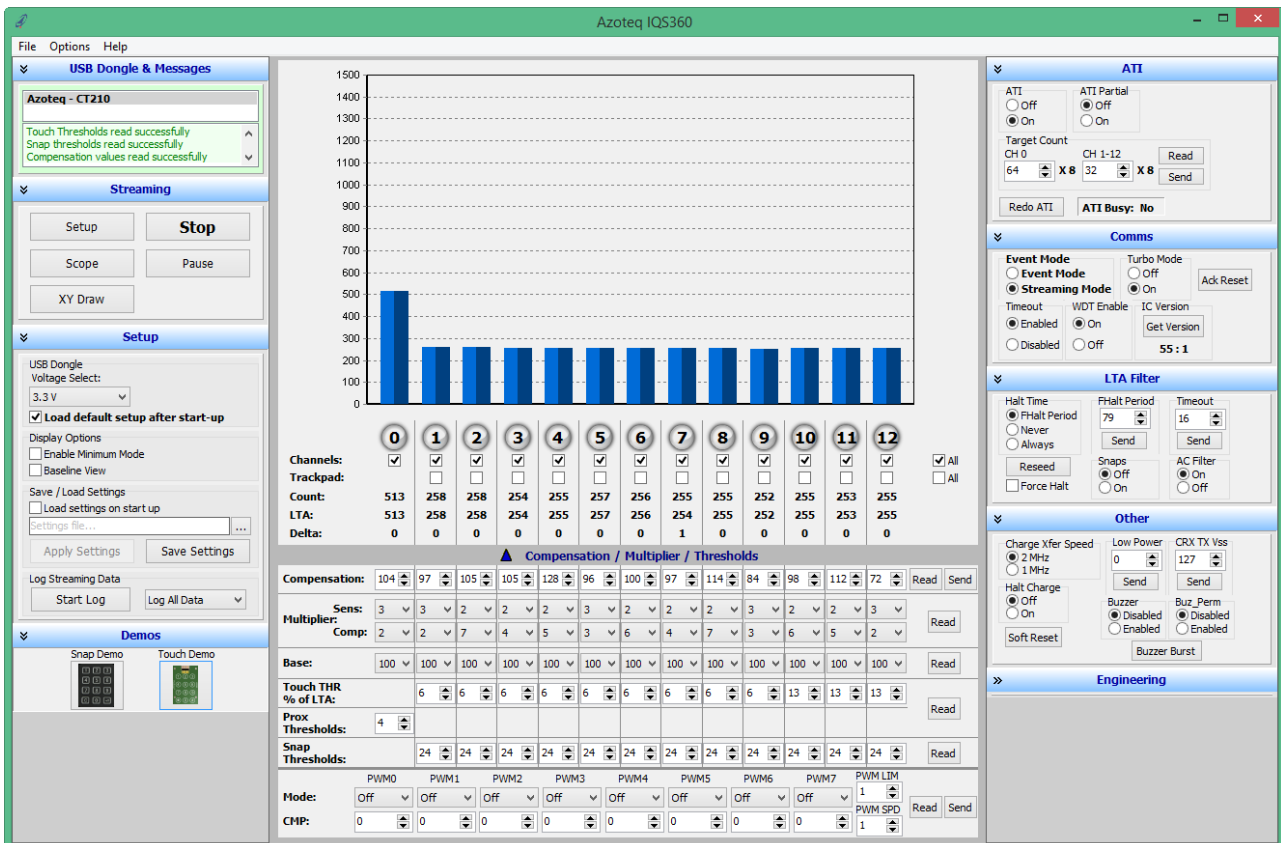

Figure 3.2 IQS360 GUI setup for touch demo board

This is achieved through the following steps:

- Click the Stop button.
- Connect the touch demo board to the driver board.
- Click the Start button.
- Click the Touch Demo icon under the Demos tab.

The GUI is now setup as shown in Figure 3.2 above. Evaluate the board by touching the various buttons. This will correspond to each channel from Channels 1 to 12. Channel 0 is a distributed proximity channel and activates when a finger comes close to a button. After we are done evaluating the touch demo board, we move on to the snap demo module board.



4 Snap demo board

The next board to evaluate is the snap demo board. Remember to click the Stop button, replace the touch board with the snap board and then click the Start button to avoid unwanted errors. The driver board with the snap board plugged in is shown below.



Figure 4.1 Snap demo board plugged into driver board

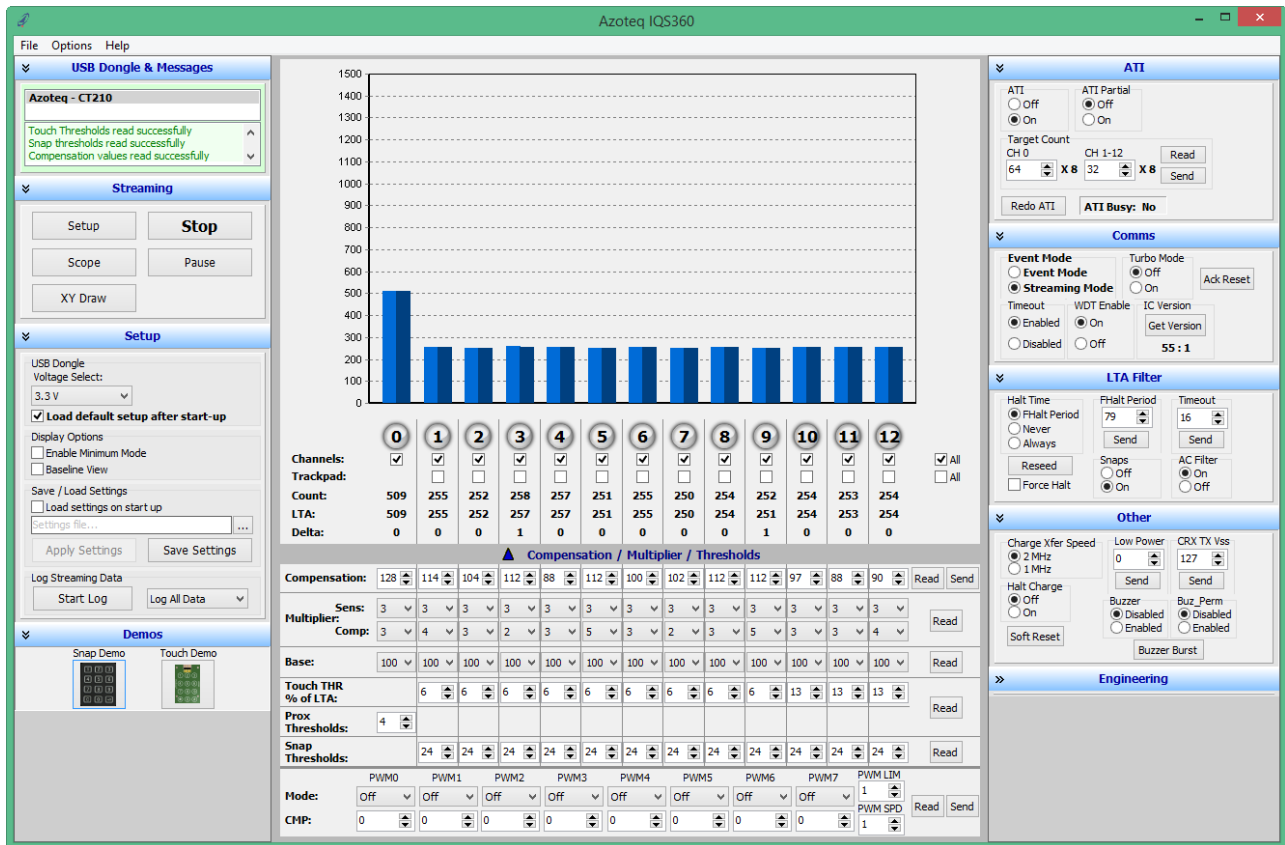

Figure 4.2 IQS360 GUI setup for snap board

Get the snap board setup by following the next couple of steps:

- Click the Stop button.
- Remove the touch demo board from the driver board.
- Connect the snap demo board to the driver board.
- Click the Start button.
- Click the Snap Demo icon under the Demos tab.

The GUI resembles that of Figure 4.2 above. Evaluate the snap board by touching and pressing a finger on the buttons. This will correspond to each channel from Channel 1 to 12. Channel 0 is a distributed proximity channel and activates when a finger comes close to a button. When a button is pressed down, a snap event occurs and the channel indicator changes from red to green. Evaluate this module board fully to see all the capabilities that this board provide.



On the right and bottom of the GUI there are multiple settings that can be changed. For a first time user we suggest to leave these settings and first evaluate the boards with the loaded settings. After evaluation the user can make adjustments to these settings for application specific options. This will help the user in achieving more/less sensitive buttons and various other settings.

5 Reference Designs

For further technical detail the datasheet should be consulted and can be found at the Azoteq website. Some reference designs from the datasheet are shown below.

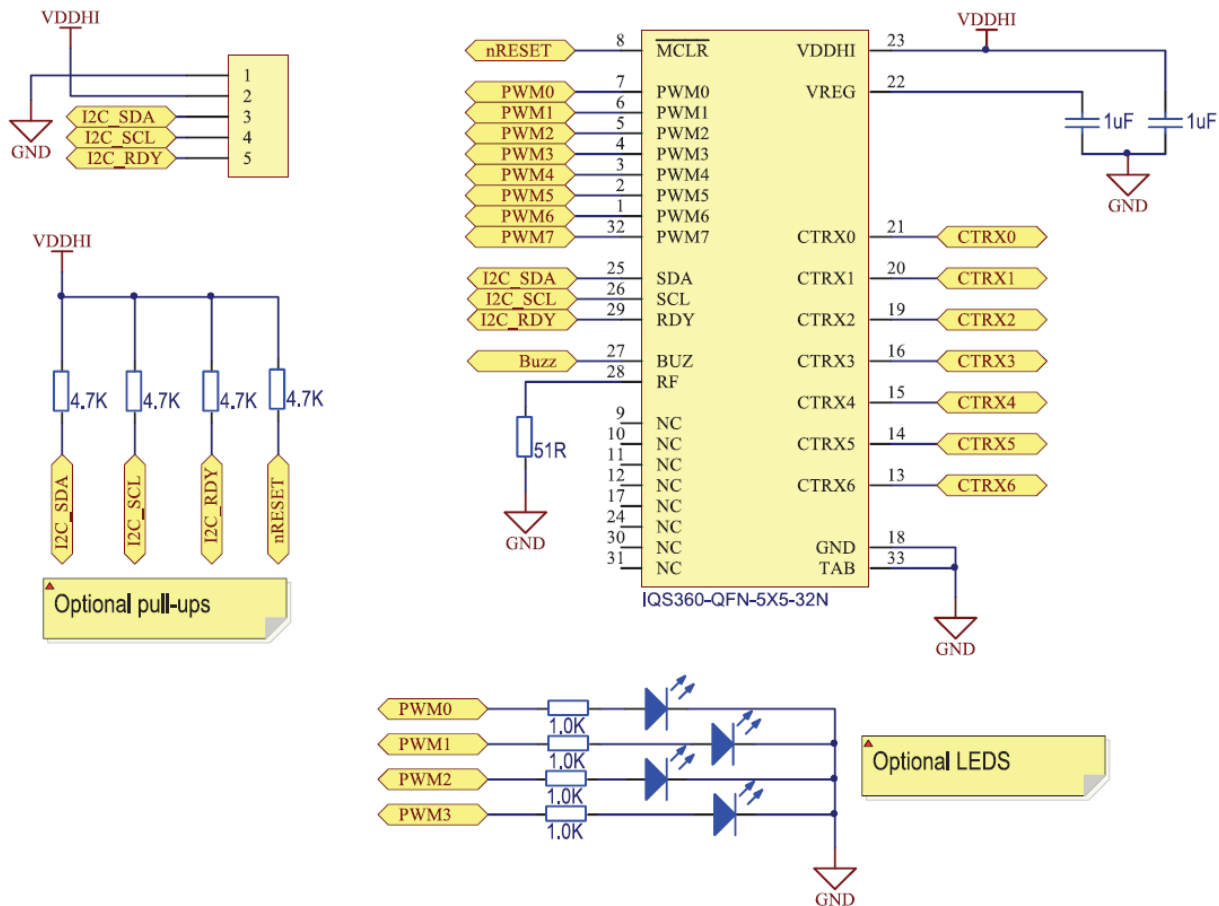

Figure 5.1 IQS360 Projected Capacitive Reference Design



Appendix A Contact Information

	USA	Asia	South Africa
Physical Address	6507 Jester Blvd Bldg 5, suite 510G Austin TX 78750 USA	Rm2125, Glittery City Shennan Rd Futian District Shenzhen, 518033 China	109 Main Street Paarl 7646 South Africa
Postal Address	6507 Jester Blvd Bldg 5, suite 510G Austin TX 78750 USA	Rm2125, Glittery City Shennan Rd Futian District Shenzhen, 518033 China	PO Box 3534 Paarl 7620 South Africa
Tel	+1 512 538 1995	+86 755 8303 5294 ext 808	+27 21 863 0033
Fax	+1 512 672 8442		+27 21 863 1512
Email	kobusm@azoteq.com	linayu@azoteq.com.cn	info@azoteq.com

Please visit www.azoteq.com for a list of distributors and worldwide representation.

The following patents relate to the device or usage of the device: US 6,249,089 B1; US 6,621,225 B2; US 6,650,066 B2; US 6,952,084 B2; US 6,984,900 B1; US 7,084,526 B2; US 7,084,531 B2; US 7,265,494 B2; US 7,291,940 B2; US 7,329,970 B2; US 7,336,037 B2; US 7,443,101 B2; US 7,466,040 B2 ; US 7,498,749 B2; US 7,528,508 B2; US 7,755,219 B2; US 7,772,781 B2; US 7,781,980 B2; US 7,915,765 B2; US 7,994,726 B2; US 8,035,623 B2; US RE43,606 E; US 8,288,952 B2; US 8,395,395 B2; US 8,531,120 B2; US 8,659,306 B2; US 8,823,273 B2; EP 1 120 018 B2; EP 1 206 168 B1; EP 1 308 913 B1; EP 1 530 178 A1; EP 2 351 220 B1; EP 2 559 164 B1; CN 1330853; CN 1783573; AUS 761094; HK 104 1401

IQ Switch®, SwipeSwitch™, ProxSense®, LightSense™, AirButton™ and the  logo are trademarks of Azoteq.

The information in this Datasheet is believed to be accurate at the time of publication. Azoteq uses reasonable effort to maintain the information up-to-date and accurate, but does not warrant the accuracy, completeness or reliability of the information contained herein. All content and information are provided on an "as is" basis only, without any representations or warranties, express or implied, of any kind, including representations about the suitability of these products or information for any purpose. Azoteq disclaims all warranties and conditions with regard to these products and information, including but not limited to all implied warranties and conditions of merchantability, fitness for a particular purpose, title and non-infringement of any third party intellectual property rights. Azoteq assumes no liability for any damages or injury arising from any use of the information or the product or caused by, without limitation, failure of performance, error, omission, interruption, defect, delay in operation or transmission, even if Azoteq has been advised of the possibility of such damages. The applications mentioned herein are used solely for the purpose of illustration and Azoteq makes no warranty or representation that such applications will be suitable without further modification, nor recommends the use of its products for application that may present a risk to human life due to malfunction or otherwise. Azoteq products are not authorized for use as critical components in life support devices or systems. No licenses to patents are granted, implicitly, express or implied, by estoppel or otherwise, under any intellectual property rights. In the event that any of the abovementioned limitations or exclusions does not apply, it is agreed that Azoteq's total liability for all losses, damages and causes of action (in contract, tort (including without limitation, negligence) or otherwise) will not exceed the amount already paid by the customer for the products. Azoteq reserves the right to alter its products, to make corrections, deletions, modifications, enhancements, improvements and other changes to the content and information, its products, programs and services at any time or to move or discontinue any contents, products, programs or services without prior notification. For the most up-to-date information and binding Terms and Conditions please refer to www.azoteq.com.

WWW.AZOTEQ.COM
info@azoteq.com