

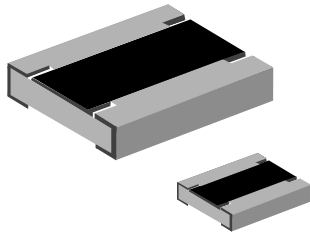

Sulfur Resistant, Long Side Termination Thick Film Chip Resistors



The sulfur resistant, long side termination thick film chip resistors series combines the capability to stand harsh environment operation with enhanced power rating performance compared to standard long side termination resistors.

FEATURES

- Superior resistance against sulfur atmosphere (H₂S), according to ASTM B809-95
- Enhanced power rating
- Long side terminations
- Enhanced thermal cycling performance
- AEC-Q200 qualified
- Material categorization: for definitions of compliance please see www.vishay.com/doc?99912



RoHS COMPLIANT HALOGEN FREE

APPLICATIONS

- Automotive
- Industrial
- Commercial

TECHNICAL SPECIFICATIONS					
DESCRIPTION	RCA0406-LS e3	RCA0612-LS e3	RCA1020-LS e3	RCA1218-LS e3	RCA1225-LS e3
Imperial size	0406	0612	1020	1218	1225
Metric size code	RR1016M	RR1632M	RR2550M	RR3246M	RR3263M
Resistance range	1 Ω to 1 MΩ; Jumper (0 Ω)			1 Ω to 2.2 MΩ; Jumper (0 Ω)	1 Ω to 1 MΩ; Jumper (0 Ω)
Resistance tolerance	± 5 %; ± 1 %				
Temperature coefficient	± 200 ppm/K; ± 100 ppm/K				
Rated dissipation, P ₇₀ ⁽¹⁾	0.25 W	0.5 W	1.0 W	1.0 W	2.0 W ⁽²⁾
Operating voltage, U _{max.} AC _{RMS} /DC	50 V	75 V	200 V	200 V	200 V
Permissible film temperature, θ _{F max.} ⁽¹⁾	155 °C				
Operating temperature range	-55 °C to +155 °C				
Max. resistance change at P ₇₀ for resistance range, ΔR/R after:					
1000 h	≤ 1.0 %				
8000 h	≤ 2.0 %				
Permissible voltage against ambient (insulation):					
1 min, U _{ins}	100 V	100 V	300 V	300 V	300 V

Notes

⁽¹⁾ Please refer to APPLICATION INFORMATION below.

⁽²⁾ Specified power rating requires dedicated mounting conditions to achieve the required thermal resistance.

APPLICATION INFORMATION

When the resistor dissipates power, a temperature rise above the ambient temperature occurs, dependent on the thermal resistance of the assembled resistor together with the printed circuit board. The rated dissipation applies only if the permitted film temperature is not exceeded.

These resistors do not feature a limited lifetime when operated within the permissible limits. However, resistance value drift increasing over operating time may result in exceeding a limit acceptable to the specific application, thereby establishing a functional lifetime.



TEMPERATURE COEFFICIENT AND RESISTANCE RANGE				
TYPE / SIZE	TCR	TOLERANCE	RESISTANCE	E-SERIES
RCA0406-LS e3	± 200 ppm/K	± 5 %	1 Ω to 1 MΩ	E24
	± 100 ppm/K	± 1 %	1 Ω to 1 MΩ	E24; E96
	Jumper, $I_{max.} = 4$ A	≤ 10 mΩ	0 Ω	-
RCA0612-LS e3	± 200 ppm/K	± 5 %	1 Ω to 1 MΩ	E24
	± 100 ppm/K	± 1 %	1 Ω to 1 MΩ	E24; E96
	Jumper, $I_{max.} = 6$ A	≤ 10 mΩ	0 Ω	-
RCA1020-LS e3	± 200 ppm/K	± 5 %	1 Ω to 1 MΩ	E24
	± 100 ppm/K	± 1 %	1 Ω to 1 MΩ	E24; E96
	Jumper, $I_{max.} = 10$ A	≤ 10 mΩ	0 Ω	-
RCA1218-LS e3	± 200 ppm/K	± 5 %	1 Ω to 2.2 MΩ	E24
	± 100 ppm/K	± 1 %	1 Ω to 2.2 MΩ	E24; E96
	Jumper, $I_{max.} = 7$ A	≤ 20 mΩ	0 Ω	-
RCA1225-LS e3	± 200 ppm/K	± 5 %	1 Ω to 1 MΩ	E24
	± 100 ppm/K	± 1 %	1 Ω to 1 MΩ	E24; E96
	Jumper, $I_{max.} = 12$ A	≤ 10 mΩ	0 Ω	-

Note

- The temperature coefficient of resistance (TCR) is not specified for 0 Ω jumpers.

PACKAGING						
TYPE / SIZE	CODE	QUANTITY	PACKAGING STYLE	WIDTH	PITCH	PACKAGING DIMENSIONS
RCA0406-LS e3	EA = ET1	5000	Paper tape acc. to IEC 60286-3, Type 1a	8 mm	4 mm	Ø 180 mm/7"
	EB = ET5	10 000				Ø 285 mm/11.25"
	EC = ET6	20 000				Ø 330 mm/13"
RCA0612-LS e3	EA = ET1	5000	Blister tape acc. to IEC 60286-3, Type 2a	12 mm	4 mm	Ø 180 mm/7"
	EB = ET5	10 000				Ø 285 mm/11.25"
	EC = ET6	20 000				Ø 330 mm/13"
RCA1020-LS e3	EF = E02	4000			4 mm	Ø 180 mm/7"
RCA1218-LS e3	EK = ET9	4000				
RCA1225-LS e3	EG = E67	2000				
	EH = E82	4000	4 mm			



PART NUMBER AND PRODUCT DESCRIPTION

Part Number: RCA061210K0FKEALS
Part Number: RCA06120000Z0EALS

R C A 0 6 1 2 1 0 K 0 F K E A L S

TYPE / SIZE	VALUE	TOLERANCE	TCR	PACKAGING	SPECIAL
RCA0406 RCA0612 RCA1020 RCA1218 RCA1225	R = decimal K = thousand M = million 0000 = jumper	F = ± 1 % J = ± 5 % Z = jumper	K = ± 100 ppm/K N = ± 200 ppm/K 0 = jumper	EA EB EC EF EG EH EK	Up to 2 digits LS = long side termination

Product Description: RCA0612-LS 100 10K 1 % ET1 e3
Product Description: RCA0612-LS 0R0 ET1 e3

RCA0612-LS	100	10K	1 %	ET1	e3
TYPE / SIZE RCA0406-LS RCA0612-LS RCA1020-LS RCA1218-LS RCA1225-LS	TCR ± 100 ppm/K ± 200 ppm/K	RESISTANCE 10R = 10 Ω 1K = 10 Ω 10K = 10 kΩ 1M0 = 1 MΩ 0R0 = jumper	TOLERANCE ± 1 % ± 5 %	PACKAGING ET1, ET5, ET6, ET9, E02, E67, E82	LEAD (Pb)-FREE e3 = pure tin termination finish



DESCRIPTION

Production is strictly controlled and follows an extensive set of instructions established for reproducibility. A cermet film layer and a glass-over are deposited on a high grade (Al₂O₃) ceramic substrate with its prepared inner contacts on both sides. A special laser is used to achieve the target value by smoothly fine trimming the resistive layer without damaging the ceramics. A special process is used to ensure resistor long term operation in harsh environment (sulfur atmosphere). The resistor elements are covered by a protective coating designed for electrical, mechanical and climatic protection. The terminations receive a final pure tin on nickel plating.

The result of the determined production is verified by an extensive testing procedure on 100 % of the individual chip resistors. Only accepted products are laid directly into the tape in accordance with **IEC 60286-3 Type 1a and Type 2a** ⁽¹⁾.

ASSEMBLY

The resistors are suitable for processing on automatic SMD assembly systems. They are suitable for automatic soldering using wave, reflow or vapor phase as shown in **IEC 61760-1** ⁽¹⁾. The encapsulation is resistant to all cleaning solvents commonly used in the electronics industry, including alcohols, esters and aqueous solutions. The suitability of conformal coatings, potting compounds and their processes, if applied, shall be qualified by appropriate means to ensure the long-term stability of the whole system.

The resistors are RoHS compliant, the pure tin plating provides compatibility with lead (Pb)-free and lead-containing soldering processes. Solderability is specified for 2 years after production or requalification. The permitted storage time is 20 years. The immunity of the plating against tin whisker growth has been proven under extensive testing.

MATERIALS

Vishay acknowledges the following systems for the regulation of hazardous substances:

- IEC 62474, Material Declaration for Products of and for the Electrotechnical Industry, with the list of declarable substances given therein ⁽²⁾
- The Global Automotive Declarable Substance List (GADSL) ⁽³⁾
- The REACH regulation (1907/2006/EC) and the related list of substances with very high concern (SVHC) ⁽⁴⁾ for its supply chain

Notes

- ⁽¹⁾ The quoted IEC standards are also released as EN standards with the same number and identical contents.
- ⁽²⁾ The IEC 62474 list of declarable substances is maintained in a dedicated database, which is available at <http://std.iec.ch/iec62474>.
- ⁽³⁾ The Global Automotive Declarable Substance List (GADSL) is maintained by the American Chemistry Council and available at www.gadsl.org.
- ⁽⁴⁾ The SVHC list is maintained by the European Chemical Agency (ECHA) and available at <http://echa.europa.eu/candidate-list-table>.

The products do not contain any of the banned substances as per IEC 62474, GADSL, or the SVHC list, see www.vishay.com/how/leadfree.

Hence the products fully comply with the following directives:

- 2000/53/EC End-of-Life Vehicle Directive (ELV) and Annex II (ELV II)
- 2011/65/EU Restriction of the Use of Hazardous Substances Directive (RoHS) with amendment 2015/863/EU
- 2012/19/EU Waste Electrical and Electronic Equipment Directive (WEEE)

Vishay pursues the elimination of conflict minerals from its supply chain, see the Conflict Minerals Policy at www.vishay.com/doc?49037.

APPROVALS

The resistors are qualified according to AEC-Q200.

Where applicable, the resistors are tested in accordance with **EN 140401-802** which refers to **EN 60115-1, EN 60115-8** and the variety of environmental test procedures of the **IEC 60068** ⁽¹⁾ series.

RELATED PRODUCTS

The RCL e3 series is not designed for sulfur-containing environment applications. For ordering RCL e3 products please refer to latest edition of datasheet: www.vishay.com/doc?20046



FUNCTIONAL PERFORMANCE

PERFORMANCE IN SULFUR-CONTAINING AMBIANCE		
TEST NAME	HUMID SULFUR VAPOR TEST	HUMID SULFUR VAPOR TEST (Accelerated)
Reference specification	ASTM B809-95	ASTM B809-95 accelerated conditions
Test conditions (temperature, humidity)	60 °C ± 2 °C 85 % ± 4 % RH	90 °C ± 2 °C 74 % ± 7 % RH
Aggressive agent	Sulfur (saturated vapor)	Sulfur (saturated vapor)
Failure criteria in VI under magnification	No silver sulfide growth at the interface between termination and protective overcoat. No signs of mechanical damage.	No silver sulfide growth at the interface between termination and protective overcoat. No signs of mechanical damage.
Failure criteria in electrical test	≤ (± 1 % R + 0.05 Ω)	≤ (± 1 % R + 0.05 Ω)
Time before failure	8000 h	1000 h

Single Pulse

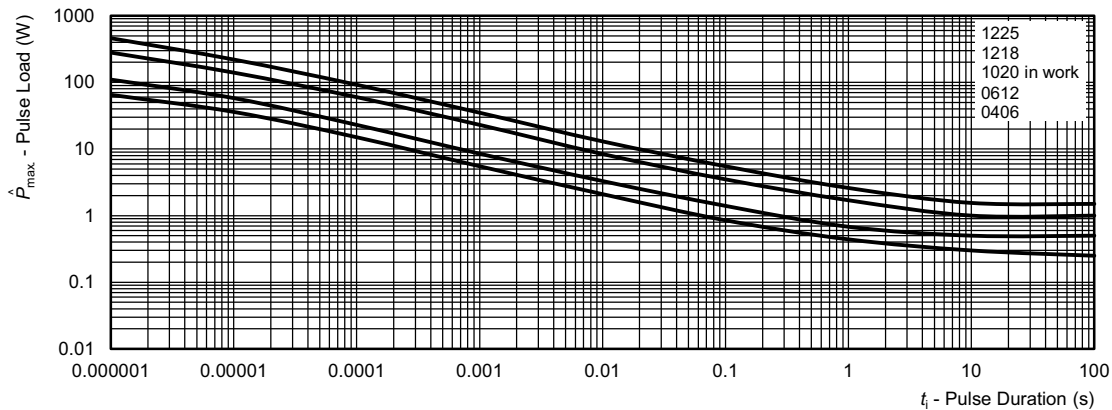

Maximum pulse load, single pulse; applicable if $\bar{P} \rightarrow 0$ and $n < 1000$ and $\hat{U} \leq \hat{U}_{max}$; for permissible resistance change equivalent to 8000 h operation

Continuous Pulse

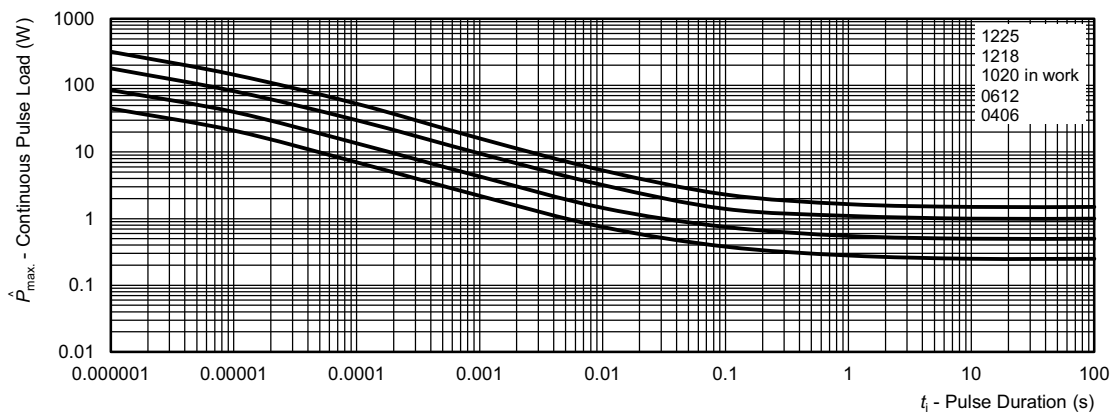

Maximum pulse load, continuous pulses; applicable if $\bar{P} \leq P(\vartheta_{amb})$ and $\hat{U} \leq \hat{U}_{max}$; for permissible resistance change equivalent to 8000 h operation



Pulse Voltage

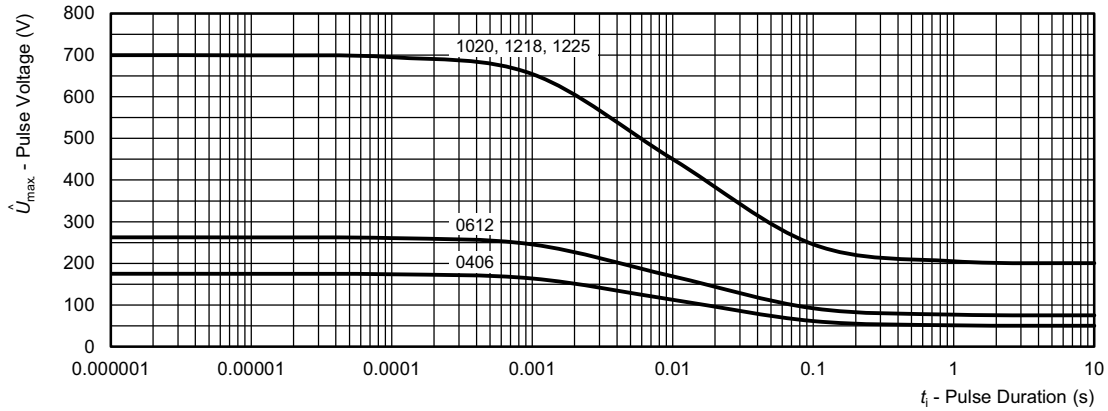

Maximum pulse voltage, single and continuous pulses; applicable if $\hat{P} \leq \hat{P}_{max.}$;
for permissible resistance change equivalent to 8000 h operation

Derating

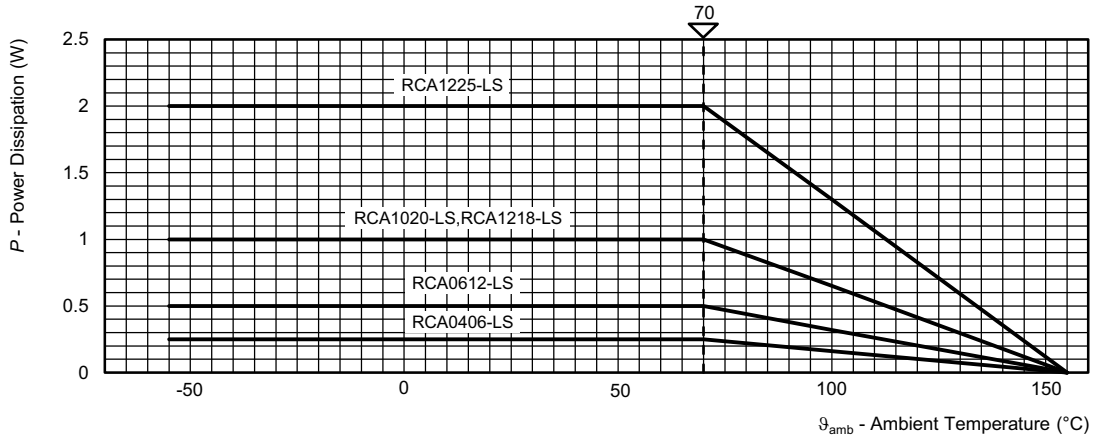



TESTS AND REQUIREMENTS

All executed tests are carried out in accordance with the following specifications:

EN 60115-1, generic specification

EN 60115-8 (successor of EN 140400), sectional specification

EN 140401-802, detail specification

IEC 60068-2-xx, test methods

The parameters stated in the Test Procedures and Requirements table are based on the required tests and permitted limits of EN 140401-802. The table presents only the most important tests, for the full test schedule refer to the documents listed above. However, some additional tests and a number of improvements against those minimum requirements have been included.

The testing also covers most of the requirements specified by EIA/IS-703 and JIS-C-5201-1.

The tests are carried out under standard atmospheric conditions in accordance with IEC 60068-1, 4.3, whereupon the following values are applied:

Temperature: 15 °C to 35 °C

Relative humidity: 25 % to 75 %

Air pressure: 86 kPa to 106 kPa (860 mbar to 1060 mbar).

TEST PROCEDURES AND REQUIREMENTS					
EN 60115-1 CLAUSE	IEC 60068-2 (1) TEST METHOD	TEST	PROCEDURE	REQUIREMENTS PERMISSIBLE CHANGE (ΔR)	
			Stability for product types:	STABILITY CLASS 1 OR BETTER	STABILITY CLASS 2 OR BETTER
			RCA-LS e3	1 Ω to 2.2 M Ω	
4.5	-	Resistance	-	$\pm 1 \%$	$\pm 5 \%$
4.8	-	Temperature coefficient	(20 / -55 / 20) °C and (20 / 155 / 20) °C	± 100 ppm/K	± 200 ppm/K
4.25.1	-	Endurance at 70 °C	$U = \sqrt{P_{70} \times R}$ or $U = U_{max.}$; whichever is the less severe; 1.5 h on; 0.5 h off 70 °C; 1000 h 70 °C; 8000 h	$\pm (1 \% R + 0.05 \Omega)$ $\pm (2 \% R + 0.1 \Omega)$	$\pm (2 \% R + 0.1 \Omega)$ $\pm (4 \% R + 0.1 \Omega)$
4.25.3	-	Endurance at upper category temperature	155 °C, 1000 h	$\pm (1 \% R + 0.05 \Omega)$	$\pm (2 \% R + 0.1 \Omega)$
4.24	78 (Cab)	Damp heat, steady state	(40 \pm 2) °C; 56 days; (93 \pm 3) % RH;	$\pm (1 \% R + 0.05 \Omega)$	
4.37	67 (Cy)	Damp heat, steady state, accelerated	(85 \pm 2) °C; (85 \pm 5) % RH; $U = \sqrt{0.1 \times P_{85} \times R} \leq 100$ V; 1000 h	$\pm (1 \% R + 0.05 \Omega)$	$\pm (2 \% R + 0.1 \Omega)$
4.23	-	Climatic sequence:	-	$\pm (1 \% R + 0.05 \Omega)$ $\pm (2 \% R + 0.1 \Omega)$	
4.23.2	2 (Bb)	dry heat	125 °C; 16 h		
4.23.3	30 (Db)	damp heat, cyclic	55 °C; 24 h; ≥ 90 % RH; 1 cycle		
4.23.4	1 (Ab)	cold	-55 °C; 2 h		
4.23.5	13 (M)	low air pressure	8.5 kPa; 2 h; (25 \pm 10) °C		
4.23.6	30 (Db)	damp heat, cyclic	55 °C; 24 h; ≥ 90 % RH; 5 cycles		
4.23.7	-	DC load	$U = \sqrt{P_{70} \times R} \leq U_{max.}$; 1 min;		
-	1 (Aa)	Cold	-55 °C; 2 h	$\pm (0.25 \% R + 0.05 \Omega)$	$\pm (0.5 \% R + 0.05 \Omega)$
4.19	14 (Na)	Rapid change of temperature	30 min at -55 °C and 30 min at 125 °C; 1000 cycles	$\pm (1 \% R + 0.05 \Omega)$	



TEST PROCEDURES AND REQUIREMENTS					
EN 60115-1 CLAUSE	IEC 60068-2 (1) TEST METHOD	TEST	PROCEDURE	REQUIREMENTS PERMISSIBLE CHANGE (ΔR)	
			Stability for product types:	STABILITY CLASS 1 OR BETTER	STABILITY CLASS 2 OR BETTER
			RCA-LS e3	1 Ω to 2.2 M Ω	
4.13	-	Short time overload	$U = 2.5 \times \sqrt{P_{70} \times R} \leq 2 \times U_{max.};$ whichever is the less severe; 5 s	$\pm (2 \% R + 0.05 \Omega)$	
4.27	-	Single pulse high voltage overload	Severity no. 4: $U = 10 \times \sqrt{P_{70} \times R} \leq$ $U = 2 \times U_{max.};$ whichever is the less severe; 10 pulses 10 μ s/700 μ s	$\pm (1 \% R + 0.05 \Omega)$ no visible damage	
4.39	-	Periodic electric overload	$U = \sqrt{15 \times P_{70} \times R} \leq$ $U = 2 \times U_{max.};$ whichever is the less severe; 0.1 s on; 2.5 s off; 1000 cycles	$\pm (1 \% R + 0.05 \Omega)$ no visible damage	
4.38	-	Electrostatic discharge (human body model)	IEC 61340-3-1 (1); 3 pos. + 3 neg. discharges; ESD voltage acc. to the size	$\pm (1 \% R + 0.05 \Omega)$	
4.22	6 (Fc)	Vibration	Endurance by sweeping; 10 Hz to 2000 Hz; no resonance; amplitude ≤ 1.5 mm or ≤ 200 m/s ² ; 7.5 h	$\pm (0.25 \% R + 0.05 \Omega)$ no visible damage	$\pm (0.5 \% R + 0.05 \Omega)$ no visible damage
4.17	58 (Td)	Solderability	Solder bath method; Sn60Pb40 non-activated flux; (235 \pm 5) $^{\circ}$ C; (2 \pm 0.2) s	Good tinning (≥ 95 % covered) no visible damage	
			Solder bath method; Sn96.5Ag3Cu0.5 non-activated flux; (245 \pm 5) $^{\circ}$ C; (3 \pm 0.3) s		
4.18	58 (Td)	Resistance to soldering heat	Solder bath method (260 \pm 5) $^{\circ}$ C; (10 \pm 1) s	$\pm (0.25 \% R + 0.05 \Omega)$	$\pm (0.5 \% R + 0.05 \Omega)$
4.29	45 (XA)	Component solvent resistance	Isopropyl alcohol; +50 $^{\circ}$ C; method 2	No visible damage	
4.32	21 (Uu ₃)	Shear (adhesion)	17.7 N	No visible damage	
4.33	21 (Uu ₁)	Substrate bending	Depth 2 mm; 3 times	$\pm (0.25 \% R + 0.05 \Omega)$ no visible damage, no open circuit in bent position	
4.7	-	Voltage proof	$U = 1.4 \times U_{ins.};$ 60 s	No flashover or breakdown	
4.35	-	Flammability, needle flame test	IEC 60695-11-5 (1); 10 s	No burning after 30 s	

Note

(1) The quoted IEC standards are also released as EN standards with the same number and identical contents.

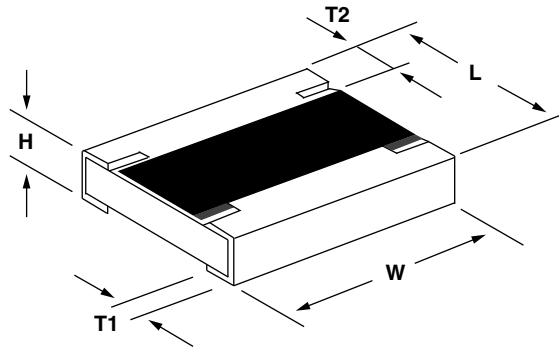
DIMENSIONS

DIMENSIONS AND MASS						
TYPE / SIZE	L (mm)	W (mm)	H (mm)	T1 (mm)	T2 (mm)	MASS (mg)
RCA0406-LS e3	1.0 ± 0.10	1.6 ± 0.10	0.35 ± 0.10	0.2 +0.10 / -0.15	0.2 ± 0.10	2
RCA0612-LS e3	1.6 ± 0.20	3.2 ± 0.20	0.55 ± 0.10	0.35 ± 0.15	0.25 ± 0.15	11
RCA1020-LS e3	2.5 ± 0.20	5.0 ± 0.20	0.55 ± 0.10	0.38 ± 0.15	0.25 ± 0.15	25.5
RCA1218-LS e3	3.2 +0.10 / -0.20	4.6 ± 0.15	0.55 ± 0.05	0.45 ± 0.20	0.4 ± 0.20	29.5
RCA1225-LS e3	3.2 ± 0.20	6.3 ± 0.20	0.70 ± 0.10	0.8 ± 0.20	0.4 ± 0.20	55

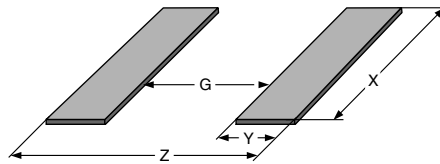
SOLDER PAD DIMENSIONS

RECOMMENDED SOLDER PAD DIMENSIONS								
TYPE / SIZE	WAVE SOLDERING				REFLOW SOLDERING			
	G (mm)	Y (mm)	X (mm)	Z (mm)	G (mm)	Y (mm)	X (mm)	Z (mm)
RCA0406-LS e3	0.30	0.80	1.95	1.90	0.35	0.60	1.75	1.55
RCA0612-LS e3	0.50	1.20	3.70	2.90	0.60	1.00	3.50	2.60
RCA1020-LS e3	1.30	1.25	5.50	3.80	1.30	1.10	5.25	3.50
RCA1218-LS e3	1.80	1.30	5.10	4.40	1.90	1.10	4.90	4.10
RCA1225-LS e3	1.10	1.80	6.80	4.70	1.20	1.60	6.60	4.40

Notes

- The given solder pad dimensions reflect the considerations for board design and assembly as outlined e.g in standards IEC 61188-5-x ⁽¹⁾ or in publication IPC-7351.
Still, the given solder pad dimensions will be found adequate for most general applications.
- ⁽¹⁾ The quoted IEC standards are also released as EN standards with the same number and identical contents.



Disclaimer

ALL PRODUCT, PRODUCT SPECIFICATIONS AND DATA ARE SUBJECT TO CHANGE WITHOUT NOTICE TO IMPROVE RELIABILITY, FUNCTION OR DESIGN OR OTHERWISE.

Vishay Intertechnology, Inc., its affiliates, agents, and employees, and all persons acting on its or their behalf (collectively, "Vishay"), disclaim any and all liability for any errors, inaccuracies or incompleteness contained in any datasheet or in any other disclosure relating to any product.

Vishay makes no warranty, representation or guarantee regarding the suitability of the products for any particular purpose or the continuing production of any product. To the maximum extent permitted by applicable law, Vishay disclaims (i) any and all liability arising out of the application or use of any product, (ii) any and all liability, including without limitation special, consequential or incidental damages, and (iii) any and all implied warranties, including warranties of fitness for particular purpose, non-infringement and merchantability.

Statements regarding the suitability of products for certain types of applications are based on Vishay's knowledge of typical requirements that are often placed on Vishay products in generic applications. Such statements are not binding statements about the suitability of products for a particular application. It is the customer's responsibility to validate that a particular product with the properties described in the product specification is suitable for use in a particular application. Parameters provided in datasheets and / or specifications may vary in different applications and performance may vary over time. All operating parameters, including typical parameters, must be validated for each customer application by the customer's technical experts. Product specifications do not expand or otherwise modify Vishay's terms and conditions of purchase, including but not limited to the warranty expressed therein.

Except as expressly indicated in writing, Vishay products are not designed for use in medical, life-saving, or life-sustaining applications or for any other application in which the failure of the Vishay product could result in personal injury or death. Customers using or selling Vishay products not expressly indicated for use in such applications do so at their own risk. Please contact authorized Vishay personnel to obtain written terms and conditions regarding products designed for such applications.

No license, express or implied, by estoppel or otherwise, to any intellectual property rights is granted by this document or by any conduct of Vishay. Product names and markings noted herein may be trademarks of their respective owners.