

TIN LEAD P/N  
70264-XYX

LEAD FREE P/N  
70264-XYXLF

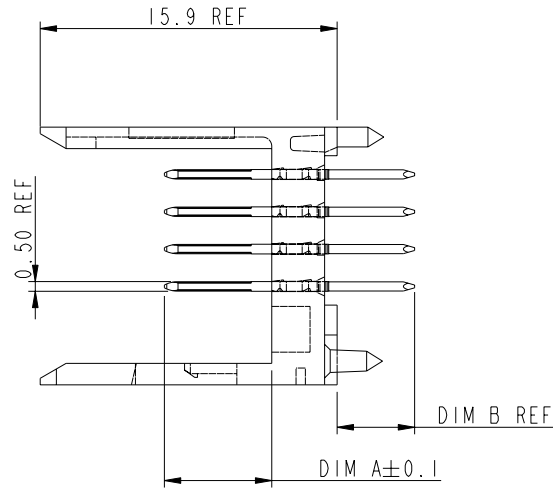
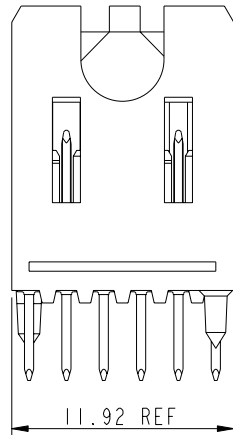
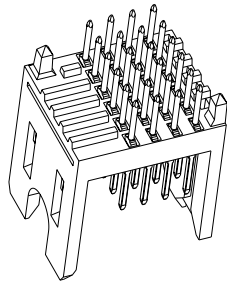
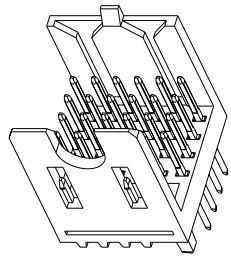
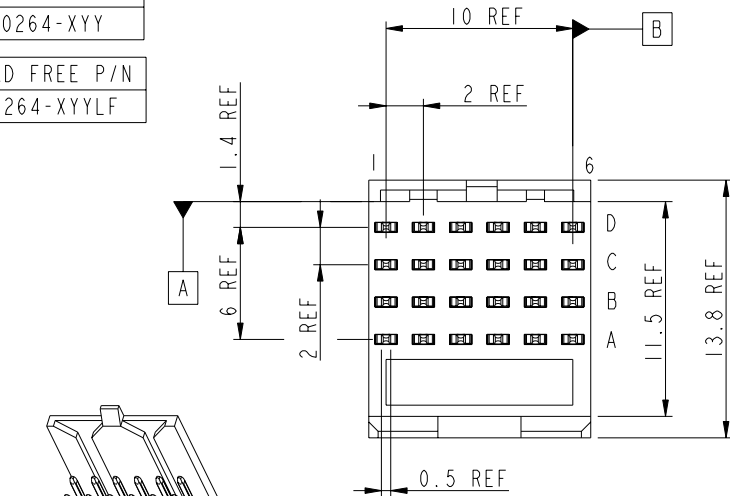

NOTES :

- FOR DIM A AND DIM B, SEE SHEET 2 AND UP.
- BODY MATERIAL : LIQUID CRYSTAL.  
POLYMER 30% GLASS.  
FLAME RETARDANT ACC. UL 94-V0.
- PIN MATERIAL :  
PHOSPHOR BRONZE.
- PLATING ON CONTACT AREA  
CONFORMS TO PERFORMANCE LEVEL  
SHOWN IN TABLE BELOW.
- PRODUCT MARKING :  
PART NUMBER DESIGNATION & BATCH I.D.
- ALL PRODUCTS WITH PART NUMBERS SHOWN IN  
SUBSEQUENT TABLES WILL BE PACKAGED IN TUBES.

GENERAL CHARACTERISTICS AND RoHS INFORMATIONS:  
SEE DRAWING C-8626-000S

PLATING IN CONTACT AREA

DASH NUMBER	PERFORMANCE LEVEL
-1YY(LF)	TELCORDIA CO
-3YY(LF)	IEC CLASS I

rev	ecn no	dr	date
G	LS3018	SPE	2003/09/09
H	LS05-0056	LGO	2005/05/04
J	LS06-0084	LGO	2006/06/30
-	-	-	-
-	-	-	-
-	-	-	-

www.fciconnect.com			surface - ISO 1302	tolerance std ISO 406 ISO 1101	projection mm	
			TOLERANCES UNLESS OTHERWISE SPECIFIED			
Dr	J.TARON	2003/01/24	ANGULAR	0.X ±0.3	size	Scale
Eng	S-PERRICHOT	2003/01/24	LINEAR	0.XX ±0.1	A3	4:1
Chr	PH-LEGARE	2003/01/24	0° ±2°	0.XXX ±0.05	ECN	LS06-0084
Appr	PH-LEGARE	2003/01/24	Product family	METRAL	Spec ref	-
			FCJ METRAL SIGNAL HEADER		dwg no	70264C
			1 MOD 4 ROW NARROW BODY STB			Rev. J
			catalog no	-	CUSTOMER	sheet 1 of 3

REV F - 2006-04-17



Copyright FCJ.

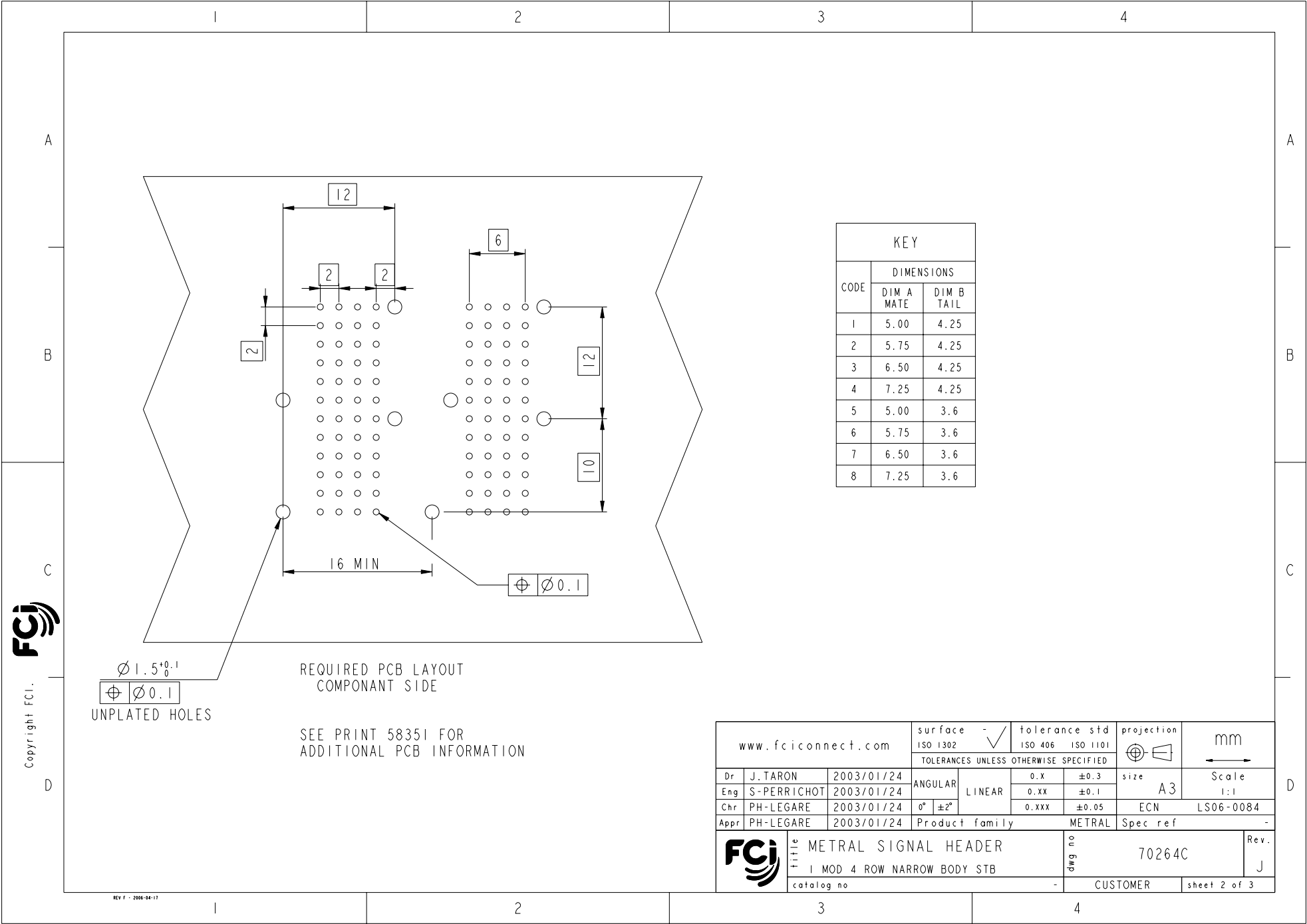

KEY		
CODE	DIMENSIONS	
	DIM A MATE	DIM B TAIL
1	5.00	4.25
2	5.75	4.25
3	6.50	4.25
4	7.25	4.25
5	5.00	3.6
6	5.75	3.6
7	6.50	3.6
8	7.25	3.6



Copyright FCi.

$\phi 1.5^{+0.1}$   
 $\phi 0.1$   
 UNPLATED HOLES

REQUIRED PCB LAYOUT  
 COMPONENT SIDE

SEE PRINT 58351 FOR  
 ADDITIONAL PCB INFORMATION

www.fciconnect.com		surface - <input checked="" type="checkbox"/> ISO 1302	tolerance std ISO 406	projection <input checked="" type="checkbox"/>	mm
		TOLERANCES UNLESS OTHERWISE SPECIFIED			
Dr	J. TARON	2003/01/24	ANGULAR	0.X	±0.3
Eng	S-PERRICHOT	2003/01/24	LINEAR	0.XX	±0.1
Chr	PH-LEGARE	2003/01/24	0° ±2°	0.XXX	±0.05
Appr	PH-LEGARE	2003/01/24	Product family	METRAL	Spec ref -
		title METRAL SIGNAL HEADER		dwg no 70264C	Rev. J
		1 MOD 4 ROW NARROW BODY STB		CUSTOMER	sheet 2 of 3
		catalog no -			

REV 1 - 2006-04-17

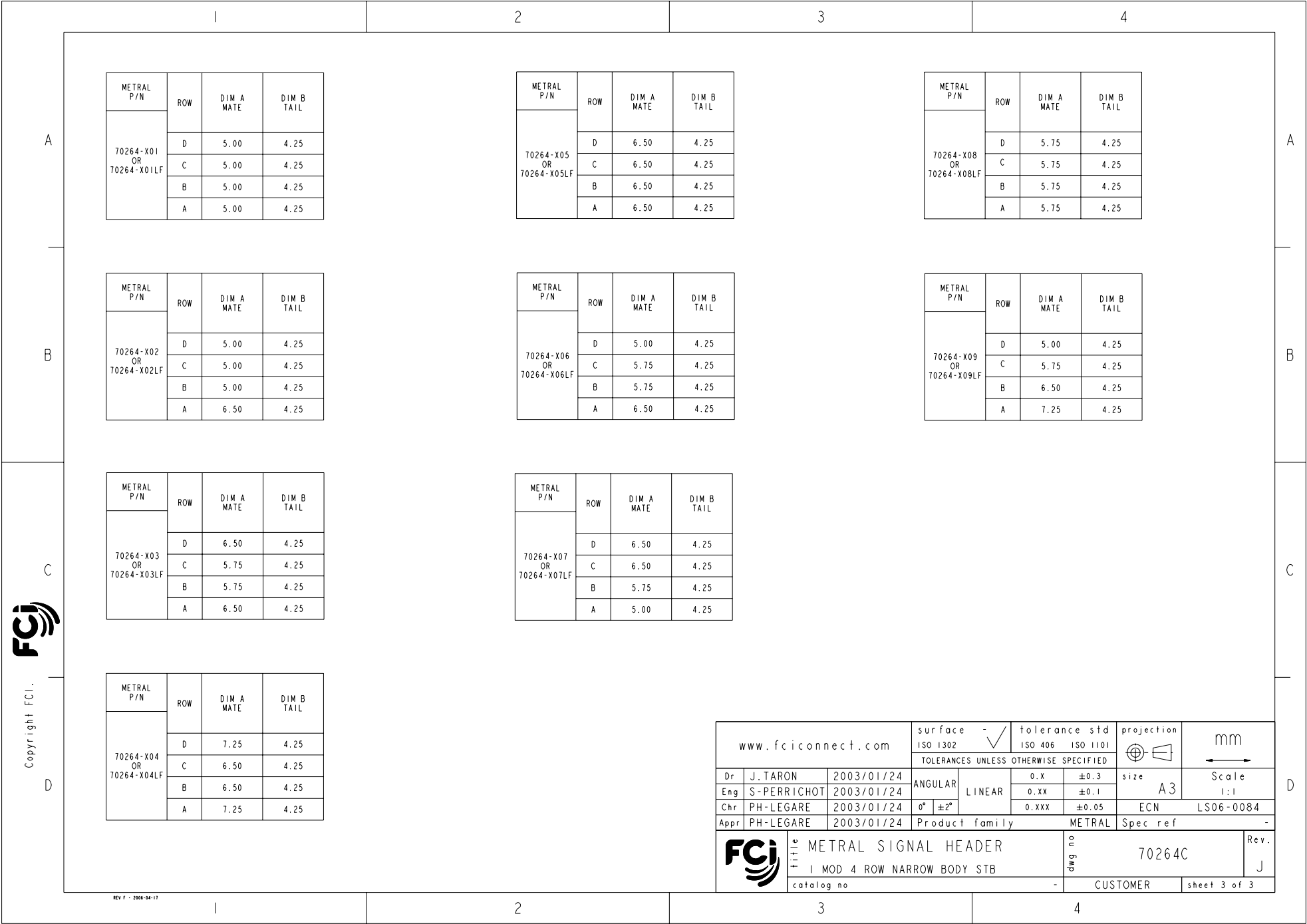

METRAL P/N	ROW	DIM A MATE	DIM B TAIL
70264-X01 OR 70264-X01LF	D	5.00	4.25
	C	5.00	4.25
	B	5.00	4.25
	A	5.00	4.25

METRAL P/N	ROW	DIM A MATE	DIM B TAIL
70264-X05 OR 70264-X05LF	D	6.50	4.25
	C	6.50	4.25
	B	6.50	4.25
	A	6.50	4.25

METRAL P/N	ROW	DIM A MATE	DIM B TAIL
70264-X08 OR 70264-X08LF	D	5.75	4.25
	C	5.75	4.25
	B	5.75	4.25
	A	5.75	4.25

METRAL P/N	ROW	DIM A MATE	DIM B TAIL
70264-X02 OR 70264-X02LF	D	5.00	4.25
	C	5.00	4.25
	B	5.00	4.25
	A	6.50	4.25

METRAL P/N	ROW	DIM A MATE	DIM B TAIL
70264-X06 OR 70264-X06LF	D	5.00	4.25
	C	5.75	4.25
	B	5.75	4.25
	A	6.50	4.25

METRAL P/N	ROW	DIM A MATE	DIM B TAIL
70264-X09 OR 70264-X09LF	D	5.00	4.25
	C	5.75	4.25
	B	6.50	4.25
	A	7.25	4.25

METRAL P/N	ROW	DIM A MATE	DIM B TAIL
70264-X03 OR 70264-X03LF	D	6.50	4.25
	C	5.75	4.25
	B	5.75	4.25
	A	6.50	4.25

METRAL P/N	ROW	DIM A MATE	DIM B TAIL
70264-X07 OR 70264-X07LF	D	6.50	4.25
	C	6.50	4.25
	B	5.75	4.25
	A	5.00	4.25

METRAL P/N	ROW	DIM A MATE	DIM B TAIL
70264-X04 OR 70264-X04LF	D	7.25	4.25
	C	6.50	4.25
	B	6.50	4.25
	A	7.25	4.25

www.fciconnect.com			surface - <input checked="" type="checkbox"/> ISO 1302	tolerance std ISO 406 ISO 1101	projection	mm
TOLERANCES UNLESS OTHERWISE SPECIFIED			ANGULAR	LINEAR	size A3	Scale 1:1
Dr	J. TARON	2003/01/24	0.X	±0.3	ECN	LS06-0084
Eng	S-PERRICHOT	2003/01/24	0.XX	±0.1	Spec ref	-
Chr	PH-LEGARE	2003/01/24	0° ±2°	0.XXX	Product family	METRAL
Appr	PH-LEGARE	2003/01/24	Product family		METRAL	Spec ref
			title METRAL SIGNAL HEADER		dwg no 70264C	Rev. J
			I MOD 4 ROW NARROW BODY STB		CUSTOMER	sheet 3 of 3
			catalog no			



Copyright FCJ.

REV 1 - 2006-04-17