

Turnkey Pentium Pro¹ power supply specification

The new IRP6VRM1 offers the power supply designer a complete turnkey solution for DC/DC converters required to power next-generation microprocessors. A synchronous buck regulator topology operating at 200kHz is employed and achieves excellent efficiency with very fast load response and tight output voltage regulation.

The new FETKY™ D²Pak is used in the synchronous recirculation circuitry to reduce board space and assembly costs while actually improving circuit efficiency through reduced stray inductance. Complete performance characterization along with a detailed schematic, bill-of-materials, PCB layout and modeling are offered to reduce the customer's design time and effort.

Purpose

This is a production-ready design. It has been thoroughly tested for performance against the Intel P6 power specification, and evaluated for manufacturability by a high volume manufacturer.

This design will not be manufactured by International Rectifier. Its purpose is to simplify the design and qualification process for our customers.

Web Site

This design may be downloaded in two formats at IR's web site (<http://www.irf.com>). One is PDF format for on screen viewing or printing, the other is in native format.

Floppy Disk

The design is also available on floppy disk. As on our web site, the floppy version contains two formats, PDF and native format.

Demo Boards

Completed boards are available free to IR customers, and at a reasonable charge to others.

Support

E-mail Chris Davis at cdavis1@irf.com for support of this design.

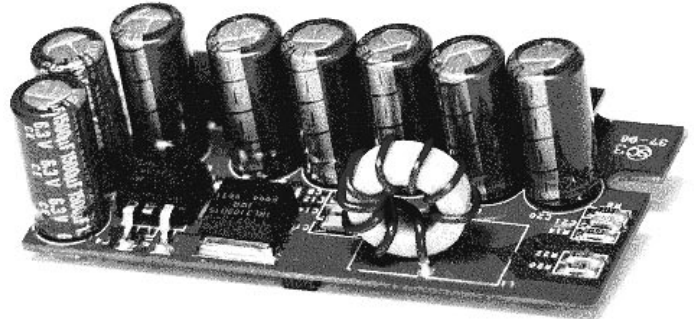

Figure 1. IRP6VRM1

Key Features

- Conforms to Intel 200Mhz P6 specification
- 12.4 ampere continuous output
- 2.0V-to-3.5V digitally selectable output
- 30A/μS transient load response capability
- Meets Pentium II power requirements
- Greater than 90% efficient
- Short circuit protected
- FETKY™ D²Pak synchronous rectifier
- Evaluation kit available: IRP6VRM1-EV

Contents

Specifications	2
Schematic Diagram	3
Bill of Materials	4
Inductor Specifications	5
Assembly Options	5
Static Performance	5
Dynamic Performance	6

Copyright Restriction

This design may be used for production or evaluation purposes under the condition that all IR labeling and identification marks remain on all boards produced using this design, or as otherwise agreed to in writing by International Rectifier.

¹: A registered trademark of Intel Corporation

Specifications

Absolute maximum ratings (Table 1)

Parameter	Min	Max	Units	Conditions / Description
5 volt input	-	6.0	V	
12 volt input	-	15.0	V	
Continuous output current	-	12.4	A	Pulse width > 100ms
Pulsed output current	-	14	A	100ms pulse width, 1% duty factor
Ambient Temperature	10	60	°C	

Electrical Input Specifications

Parameter	Min	Typ	Max	Units	Conditions / Description
5 volt input (5Vin)	4.75	5.0	5.25	V	Supply meet all output specifications
5 volt input current	-	-	10	A	All line and load conditions
12 volt input (12Vin)	11.8	12.0	13.2	V	Supply meets all output specifications
12 volt input current	-	12.5	50	mA	All line and load conditions

Power Output Specifications (all specified line and load conditions)

Parameter	Min	Typ	Max	Units	Conditions / Description
Voltage Range	2.0	-	3.5	V	Selected by VID[0:3]
Current	0	-	12.4	A	
Voltage regulation	-5	-	+5	%	Of nominal VID set point. Includes 30A/us transients from min-to-max-to-min load current
Ripple voltage	-1	-	+1	%	Percent of set point.
Turn on settling time	-	1.5	10	mS	Within ±10% of VID set point

Digital Input / Output Specifications

Signal	Input / Output	Conditions / Description
PWRGD	output	Open collector output. Logic 1 output signifies that the voltage output of the module is within ±10% of the selected level
OUTEN	input	Open collector input. Logic 0 disables the module output.
UP#	input	Open. Not required in this module since the module has upgrade capability.
VID[0:3]	input	Open collector input. Selects nominal output voltage as shown in table #2.

Output Fault Protection

Parameter	Min	Typ	Max	Units	Conditions / Description
Short circuit protection	13	17	21	A	Limits output current during short circuit or overload
Over voltage protection	+10	-	+20	%	Shuts down the power supply when the output voltage exceeds 10%-to-20% above the set point

VID Codes (Table 2)

VccP	VID3	VID2	VID1	VID0	Comments
2.0	1	1	1	1	No CPU
2.1	1	1	1	0	Optional
2.2	1	1	0	1	Optional
2.3	1	1	0	0	Optional
2.4	1	0	1	1	Optional
2.5	1	0	1	0	Optional
2.6	1	0	0	1	Optional
2.7	1	0	0	0	
2.8	0	1	1	1	
2.9	0	1	1	0	
3.0	0	1	0	1	
3.1	0	1	0	0	
3.2	0	0	1	1	
3.3	0	0	1	0	
3.4	0	0	0	1	
3.5	0	0	0	0	

Fig 2. Connector pin out

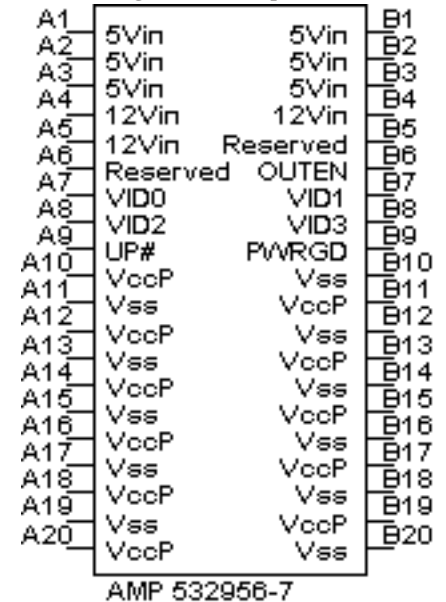

Fig 3. Silk screen top view

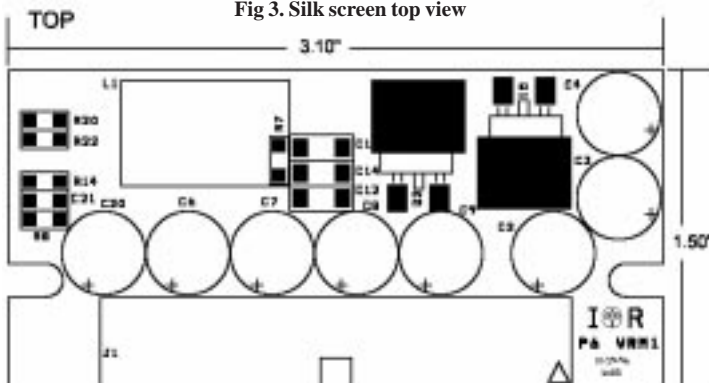
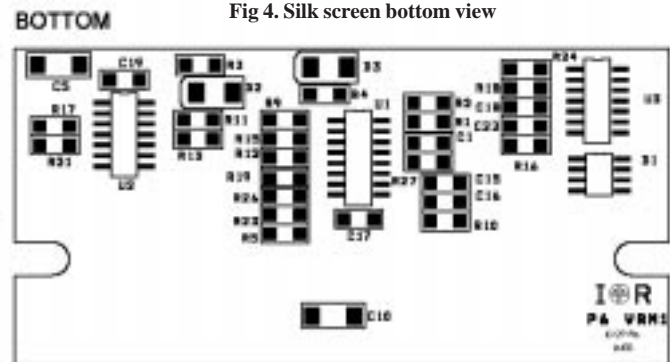
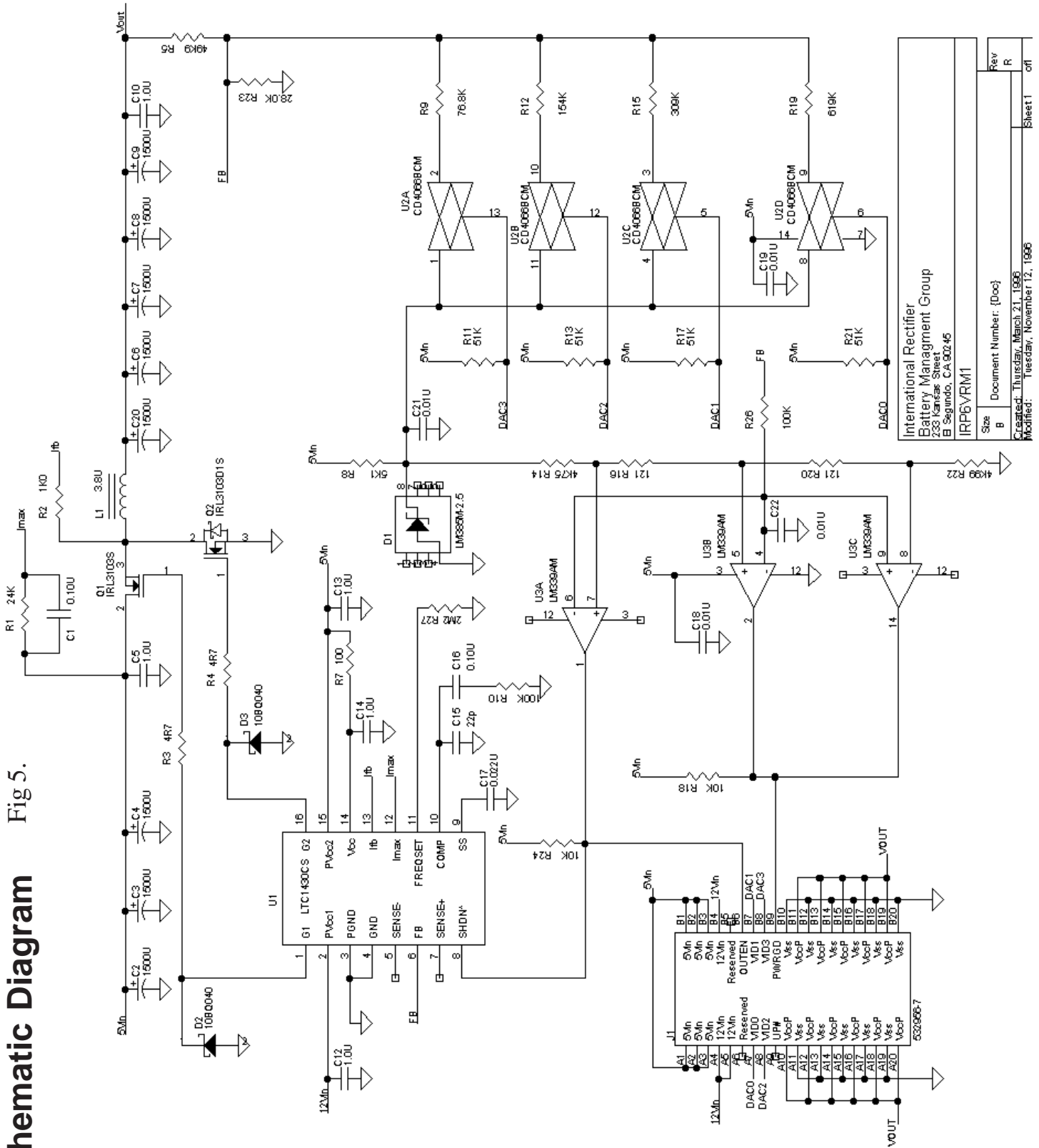

Fig 4. Silk screen bottom view



Schematic Diagram Fig.5.



International Rectifier
Battery Management Group
233 Kankoa Street
B. Segundo, CA 90245
IRP6VRM1

Size	Document Number: {Doc}	Rev
B		R
	Created: Thursday, March 21, 1996	Sheet1
	Modified: Tuesday, November 12, 1996	off

4 Bill of Materials

(Table #3)

Item	Qty	Reference	Part	Description	Manufacturer	Man PN	Vendor	Vend PN
1	2	C1,C16	0.10U	20% 1206 Z5U capacitor	Novacap	1206Z104M500N	Garrett	1206Z104M500N
2	8	C2,C3,C4,C6,C7,C8,C9,C20	1500U	Radial lead electrolytic capacitor	Sanyo	6MV1500GX	Sanyo	6MV1500GX
3	5	C5,C10,C12,C13,C14	1.0U	20% 1808 Z5U capacitor	Novacap	1808Z105M250N	Garrett	1808Z105M250N
4	1	C15	22p	5% 1206 NPO capacitor	Novacap	1206N220J101N	Garrett	1206N220J101N
5	1	C17	0.022U	10% 1206 X7R capacitor	Novacap	1206B223K500N	Garrett	1206B223K500N
6	4	C18,C19,C21,C22	0.01U	10% 1206 X7R capacitor	Novacap	1206B103K500N	Garrett	1206B103K500N
7	1	D1	LM385M-2.5	2.5V S08 Precision shunt reference	National Semiconductor	LM385M-2.6	Anthem	LM385M-2.5-ND
8	2	D2,D3	10BQ040	1A 40V SM schottky diode	International Rectifier	10BQ040	IR	10BQ040
9	1	J1	532956-7	40 Pin connector	AMP	532956-7	AMP	532956-7
10	1	L1	3.8U	9t of 16g on Micrometals T60-52 core	Pacific Transformer	IR001	Pacific Transformer	IR001
11	1	Q1	IRL3103S	N-Channel Power MOSFET	International Rectifier	IRL3103S	IR	IRL3103S
12	1	Q2	IRL3103D1S	N-Channel Super FETKY	International Rectifier	IRL3103D1S	IR	IRL3103D1S
13	1	R1	24K	5% 1206 Resistor	Panasonic	ERJ-8GEYJ243V	Digi-Key	P24KETR-ND
14	1	R2	1K0	5% 1206 Resistor	Panasonic	ERJ-8GEYJ102V	Digi-Key	P1.0KETR-ND
15	2	R4,R3	4R7	5% 1206 Resistor	Panasonic	ERJ-8GEYJ4R7V	Digi-Key	P4R7ETR-ND
16	1	R5	49K9	1% 1206 Resistor	Panasonic	ERJ-8ENF4992V	Digi-Key	P49.9KFTR-ND
17	1	R7	100	5% 1206 Resistor	Panasonic	ERJ-8GEYJ101V	Digi-Key	P100ETR-ND
18	1	R8	5K1	5% 1206 Resistor	Panasonic	ERJ-8GEYJ512V	Digi-Key	P5.1KETR-ND
19	1	R9	76.8K	1% 1206 Resistor	Panasonic	ERJ-8ENF7682V	Digi-Key	P76.8KFTR-ND
20	2	R26,R10	100K	5% 1206 Resistor	Panasonic	ERJ-8GEYJ104V	Digi-Key	P100KETR-ND
21	4	R11,R13,R17,R21	51K	5% 1206 Resistor	Panasonic	ERJ-8GEYJ511V	Digi-Key	P51KETR-ND
22	1	R12	154K	1% 1206 Resistor	Panasonic	ERJ-8ENF1543V	Digi-Key	P154KFTR-ND
23	1	R14	4K75	1% 1206 Resistor	Panasonic	ERJ-8ENF4751V	Digi-Key	P4.75KFTR-ND
24	1	R15	309K	1% 1206 Resistor	Panasonic	ERJ-8ENF3093V	Digi-Key	P309KFTR-ND
25	2	R16,R20	121	1% 1206 Resistor	Panasonic	ERJ-8ENF1210V	Digi-Key	P121FTR-ND
26	2	R18,R24	10K	5% 1206 Resistor	Panasonic	ERJ-8GEYJ103V	Digi-Key	P10KETR-ND
27	1	R19	619K	1% 1206 Resistor	Panasonic	ERJ-8ENF6193V	Digi-Key	P619KFTR-ND
28	1	R22	4K99	1% 1206 Resistor	Panasonic	ERJ-8ENF4991V	Digi-Key	P4.99KFTR-ND
29	1	R23	28.0K	1% 1206 Resistor	Panasonic	ERJ-8ENF2802V	Digi-Key	P28.0KFTR-ND
30	1	R27	2M2	5% 1206 Resistor	Panasonic	ERJ-8GEYJ225V	Digi-Key	P2.2METR-ND
31	1	U1	LTC1430CS	Synchronous Buck Controller	Linear Technology	LTC1430CS	Linear Technology	LTC1430CS
32	1	U2	CD4066BCM	Quad Bilateral Switch	National Semiconductor	CD4066BCM	Anthem	CD4066BCM-ND
33	1	U3	LM339AM	Quad Comparator	National Semiconductor	LM339AM	Anthem	LM339AM

Manufacturers

Novacap----- (800) 227-2447
 Panasonic----- (800) 922-0028
 National Semiconductor----- (800) 272-9959
 Linear Technology----- (714) 453-4650
 Micrometals Inc----- (714) 970-9400
International Rectifier----- (310) 322-3331
 AMP----- (800) 522-6752
 Sanyo----- (619) 661-6835

Distributors

Digi-Key----- (800) 344-4539
 Garrett----- (800) 767-0081
 Anthem----- (714) 768-4444

PCB Fabrication

South Coast Circuits----- (714) 966-2108

Turn Key Manufacturing

Corlund Electronics Corporation (805) 499-6877

Inductor Winding

Pacific Transformer----- (714) 779-0450

Delivery

Items used in this design were found to have production quantity lead times of under 10 weeks. Most were well under 8 weeks.

Inductor Specifications

Inductor Drawing

The specified inductor IR001, or optional IR002 can be purchased, assembled and tested (see BOM).

Fig 6. IR001

Core = Micrometals T60-52
Winding = 9 turns, 18 gauge, single layer
Finished OD = 0.800 MAX
Finished Height = 0.400 MAX
Leads extend 0.2" past OD, Stripped and tinned 0.2"

3.8uH Nominal @ 0A DC
2.5uH Nominal @ 14A DC



International Rectifier Battery Management Group 230 Kandler Street El Segundo, CA 90245		
3.8uH, 12.4A inductor		
Size	Document Number: IR001	Rev
A		1
Created: Thursday, July 11, 1996		Sheet 1 of 1
Modified: Thursday, October 10, 1996		

Fig 7. IR002

Core = Micrometals T60-52
Winding = 13 turns, 18 gauge, single layer
Finished OD = 0.800 MAX
Finished Height = 0.400 MAX
Leads extend 0.2" past OD, Stripped and tinned 0.2"

8.0uH Nominal @ 0A DC
5.5uH Nominal @ 8.6A DC



International Rectifier Battery Management Group 230 Kandler Street El Segundo, CA 90245		
8.0uH, 8.6A inductor		
Size	Document Number: IR002	Rev
A		1
Created: Thursday, October 10, 1996		Sheet 1 of 1
Modified: Thursday, October 10, 1996		

Assembly Options

Options For 8A Output (table #4)

REF	From	To
C4	1500UF	Don't install
C6, C8	1500UF	Don't install
Q1	IRL3103S	IRL3303S
Q2	IRL3103D1S	IRL3303S
L1	IR001	IR002

8 Ampere Design Adaptation

Many motherboards do not require the full 12.4 ampere current output. In this case the IRP6VRM1 can be adapted to lower current levels by using the assembly options shown. These options will reduce cost by removing components and by using smaller die size MOSFETs. Substitution of a MOSFET for a FETKY will reduce efficiency somewhat, but junction temperatures will still remain well within a safe limit.

Fig 8. Typical T_j of Q1 @ $T_a = 50^\circ\text{C}$, still air

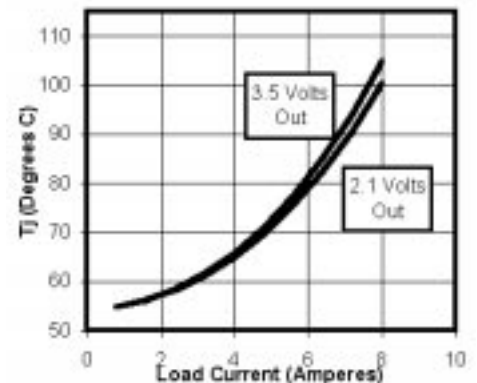

Static Performance

Fig 9. Average Efficiency

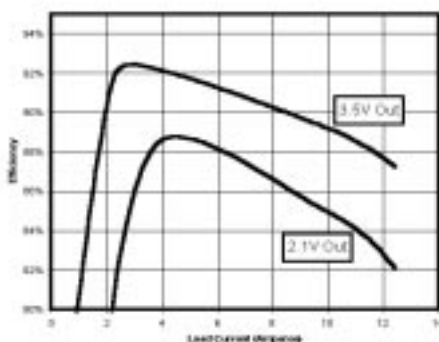

Efficiency

Efficiency is required to be at least 80% at full load. Thanks to the very efficient IRL3103S and the FETKY IRL3103D1S, IRP6VRM1 exceeds the required specification by a wide margin.

Maximum Junction Temperature

Analysis of Q1 junction temperature shows that it remains within specifications at an ambient temperature of 50°C , even in still air.

Fig 10. Typical T_j of Q1 @ $T_a = 50^\circ\text{C}$, still air

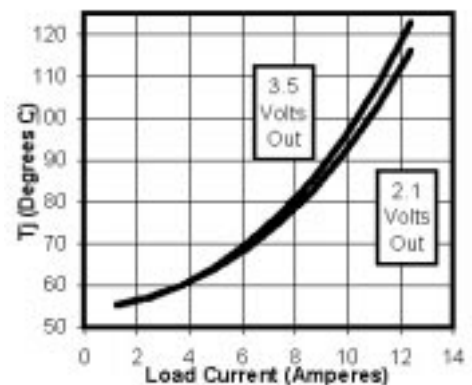

Dynamic Performance

Fig 11. Load Regulation, 2.1 Volts Out

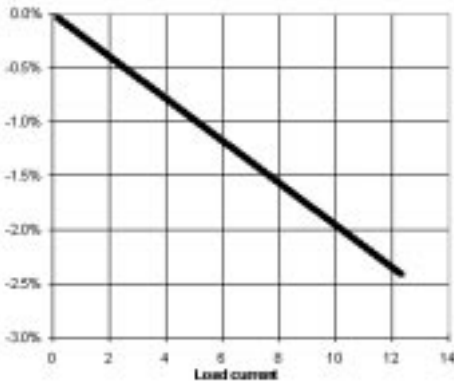

Load Regulation

The output must stay within its +5% specification from no load to full load.

Fig 12. Load Regulation, 3.5 Volts Out

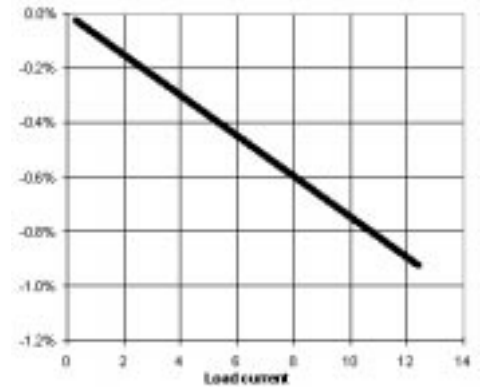
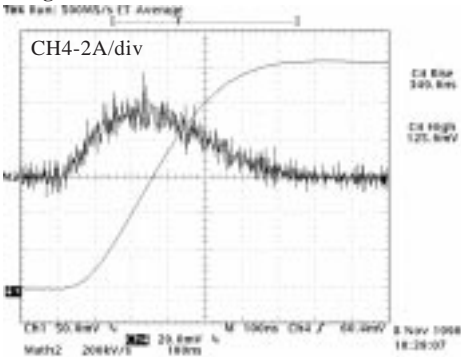

Fig 13. Transient Load Current Rise Time



Transient Load Test Conditions

The Intel specification requires the supply to stay within its $\pm 5\%$ specification during transient load event of 0.3A-to-12.4A in 413ns. Although most motherboards do not require this full level of performance, the IRP6VRM1 meets the full transient response specification.

Fig 14. Transient Load Current Fall time

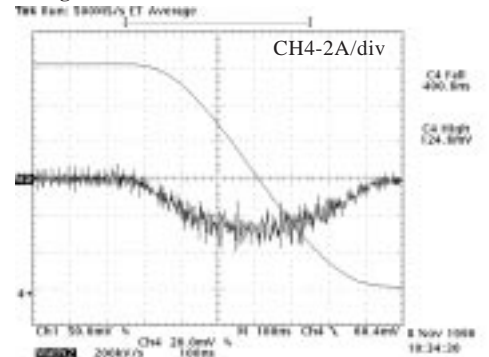
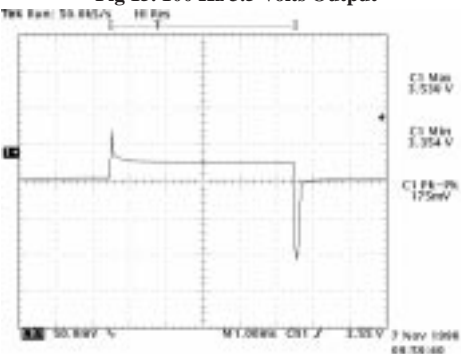

Fig 15. 100 Hz 3.5 Volts Output



Transient Load At 3.5V Out

Performance at 100kHz is dominated by stray output inductance. This inductance is a combination of output capacitor ESL and board / connector inductance. Performance at 100Hz is dominated by loop characteristics.

	Limit	100Hz	100kHz
Min	3.325	3.354	3.351
Max	3.675	3.530	3.519

Fig 16. 100 kHz 3.5 Volts Output

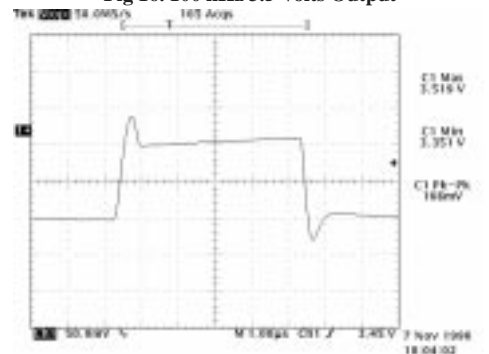

Dynamic Performance (continued)

Fig 17. 100Hz 2.1 Volts Output

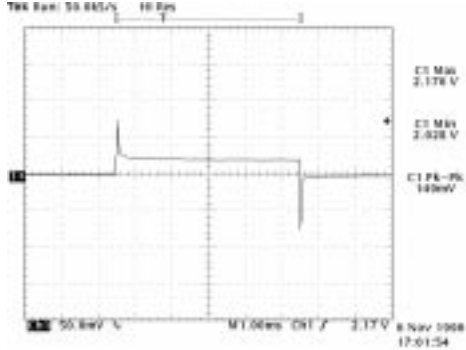

Transient Load At 2.1V Out

Performance at 2.1 volts out is very similar to that at 3.5 volts. The notable exception is a reduction of the negative spike at the current rising edge. This is due to having more average voltage available to change the current in L1.

	Limit	100Hz	100kHz
Min	1.995	2.028	2.004
Max	2.205	2.176	2.163

Fig 18. 100kHz 2.1 Volts Output

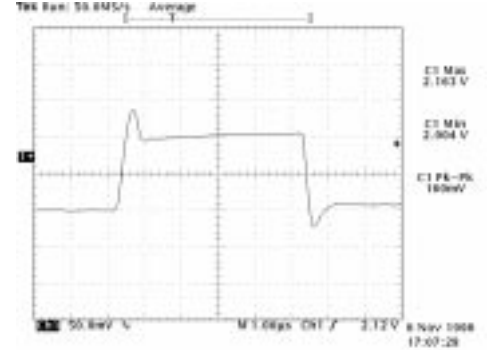
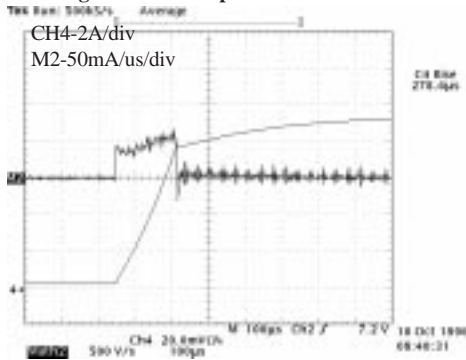

Fig 19. Turn On Input Current Waveform



Input di/dt During Transient Load

The Intel guideline (optional) specification calls for a maximum input di/dt during transient load of 0.1A/µs. The IRP6VRM1 readily meets this specification at turn on, but falls short at turn off.

This is common to all VRM boards evaluated by IR, regardless of manufacturer. It should not cause difficulties for most users, but if it is an issue for your design, add input inductance.

Fig 20. Falling Input Current Waveform

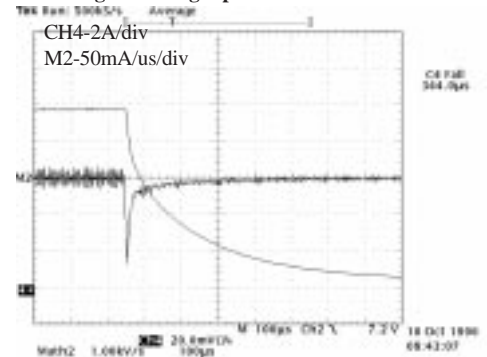

Dynamic Performance (continued)

Fig 21. 2.1 Volts Out, No Load

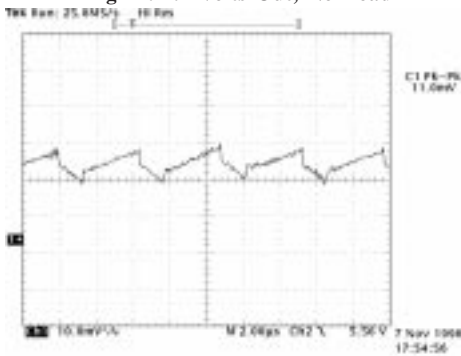

Output Ripple Voltage

Output ripple voltage is specified as a maximum 2% p-p.

Out	Limit	Measured
2.1V	42mV	11mV
3.5V	70mV	16mV

Fig 22. 3.5 Volts Out, Full Load

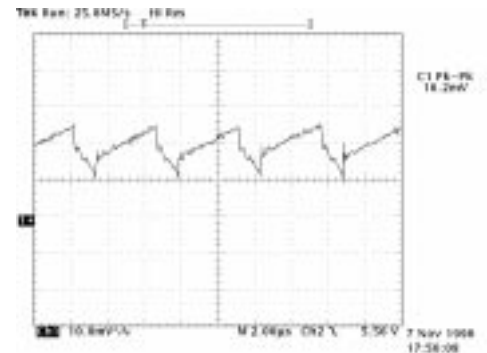
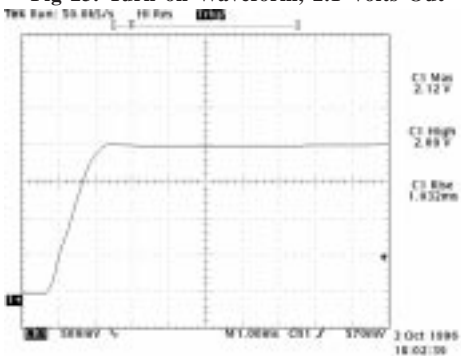

Fig 23. Turn on Waveform, 2.1 Volts Out



Turn On Transient

Output voltage must remain within 10% of the nominal set point.

Out	Limit	Measured
2.1V	2.31	2.12
3.5V	3.85	3.84

Fig 24. Turn on Waveform, 3.5 Volts Out

