

QT-Brightek Optocoupler Series

4-PIN DC Input Photodarlington

Part No.: QTM415

Product: QTM415	Date: April 13, 2018	Page 1 of 12
	Version# 1.1	



Table of Contents:

Introduction3
Absolute Maximum Rating4
Electrical Characteristic (T_A=25 °C).....5
Characteristic Curves.....6
Solder Profile & Footprint.....8
Packing & Labeling10
Device Marking11
Ordering Information11
Revision History12
Disclaimer12

Introduction

Feature:

- High Isolation voltage between input and output (Viso = 3750V rms)
- DC input with transistor output
- Operating Temperature up to 110 °C
- Mini-Flat package

Certification & Compliance:

- Pb free and RoHS Compliant
- UL recognized (File #E338132)
- cUL recognized (File #E338132)
- VDE (Pending Approval)

Schematic:

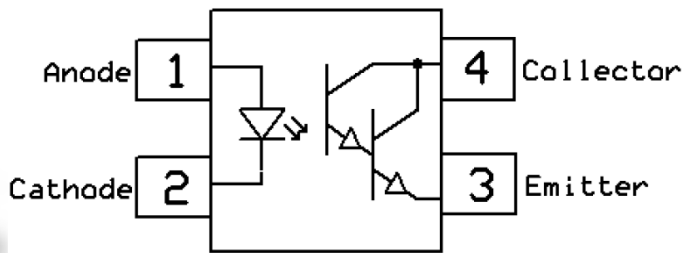

Dimension: (Dot location indicates pin 1)

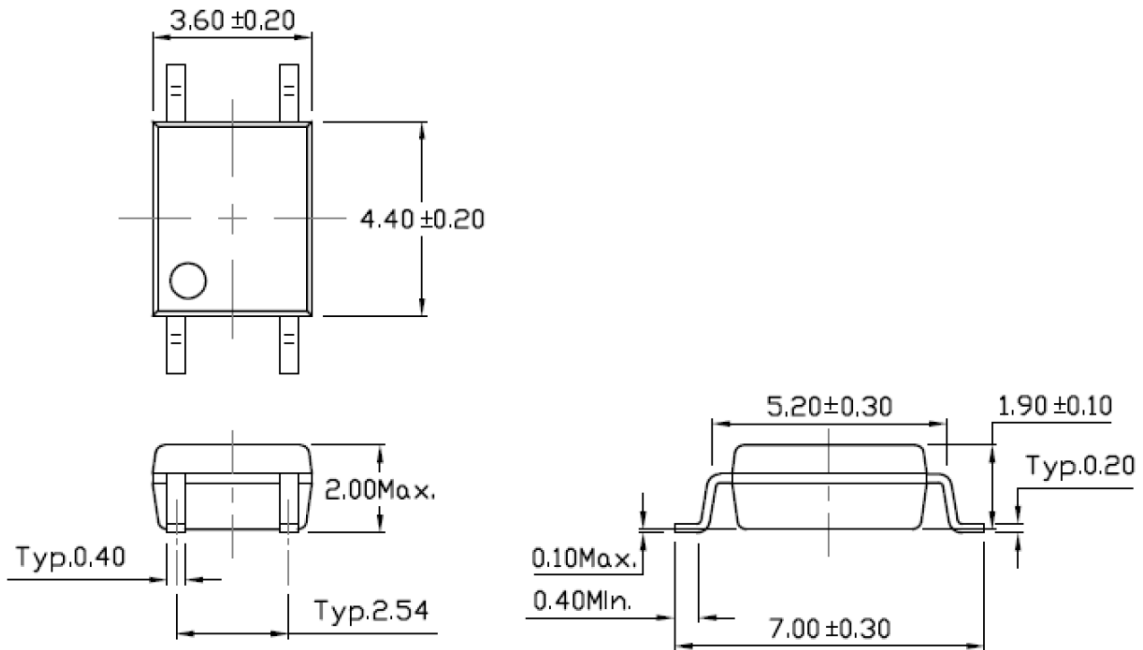

All Dimensions are in mm

Absolute Maximum Rating

Symbol	Parameter	Rating	Units
V _{ISO}	Isolation Voltage	3750	V _{RMS}
T _{STG}	Storage Temperature	-55 ~ +150	°C
T _{OPR}	Operating Temperature	-55 ~ +110	°C
T _{SOL}	Lead Solder Temperature	260 for 10 sec	°C
P _{TOT}	Total Power Dissipation	170	mW
EMITTER			
I _F	Continuous Forward Current	50	mA
I _{FP}	Peak Forward Current (≤ 1us, 300pps)	1	A
V _R	Reverse Voltage	6	V
P _D	Power Dissipation	70	mW
	Power Dissipation Derated above 100°C	-	mW/°C
DETECTOR			
B _{VCEO}	Collector-Emitter Breakdown Voltage	60	V
B _{VECO}	Emitter-Collector Breakdown Voltage	7	V
I _C	Collector current	80	mA
P _C	Power Dissipation	150	mW

Electrical Characteristic (T_A=25 °C)

Emitter

Symbol	Characteristics	Device	Test Condition	Range			Unit
				Min	Typ	Max	
V _F	Forward Voltage	-	I _F = 10mA	-	1.4	1.6	V
I _R	Reverse Current		V _R =6V	-	-	5	uA
C _{IN}	Input Capacitance		f =1kHz	-	10	250	pF

Detector

Symbol	Characteristic	Device	Test Condition	Range			Unit
				Min	Typ	Max	
B _{VCEO}	Collector-Emitter Breakdown Voltage	-	I _c =100uA	35	-	-	V
B _{VECO}	Emitter-Collector Breakdown Voltage	-	I _c =100uA	7	-	-	uA
I _{CEO}	Collector-Emitter Dark Current	-	V _{CE} =10V, I _F =0mA	-	-	1	uA

Transfer Characteristics (T_A=0 to 70C unless specified otherwise)

Symbol	Characteristic	Device	Test Condition	Range			Unit
				Min	Typ	Max	
CTR	Current Transfer Ratio	QTM415	I _F = 1mA, V _{CE} =2V	600	-	-	%
		QTM415A		3000	-	6500	
		QTM415B		5500	-	-	
V _{CE(SAT)}	Collector-Emitter Saturation Voltage		I _F = 20mA, I _c =5mA	-	0.8	1	V
R _{IO}	Isolation Resistance		V _{IO} =500V _{DC}	5x10 ¹⁰	-	-	Ω
C _{IO}	Isolation Capacitance		f=1MHz	-	0.5	1.0	pF

Switching Characteristics (T_A=25°C, V_{CC}=5V)

Symbol	Characteristic	Device	Test Condition	Range			Unit
				Min	Typ	Max	
t _r	Rise Time		I _c =2mA, V _{CE} 2V, R _L =100Ω	-	-	300	us
t _f	Fall Time			-	-	250	

Characteristic Curves

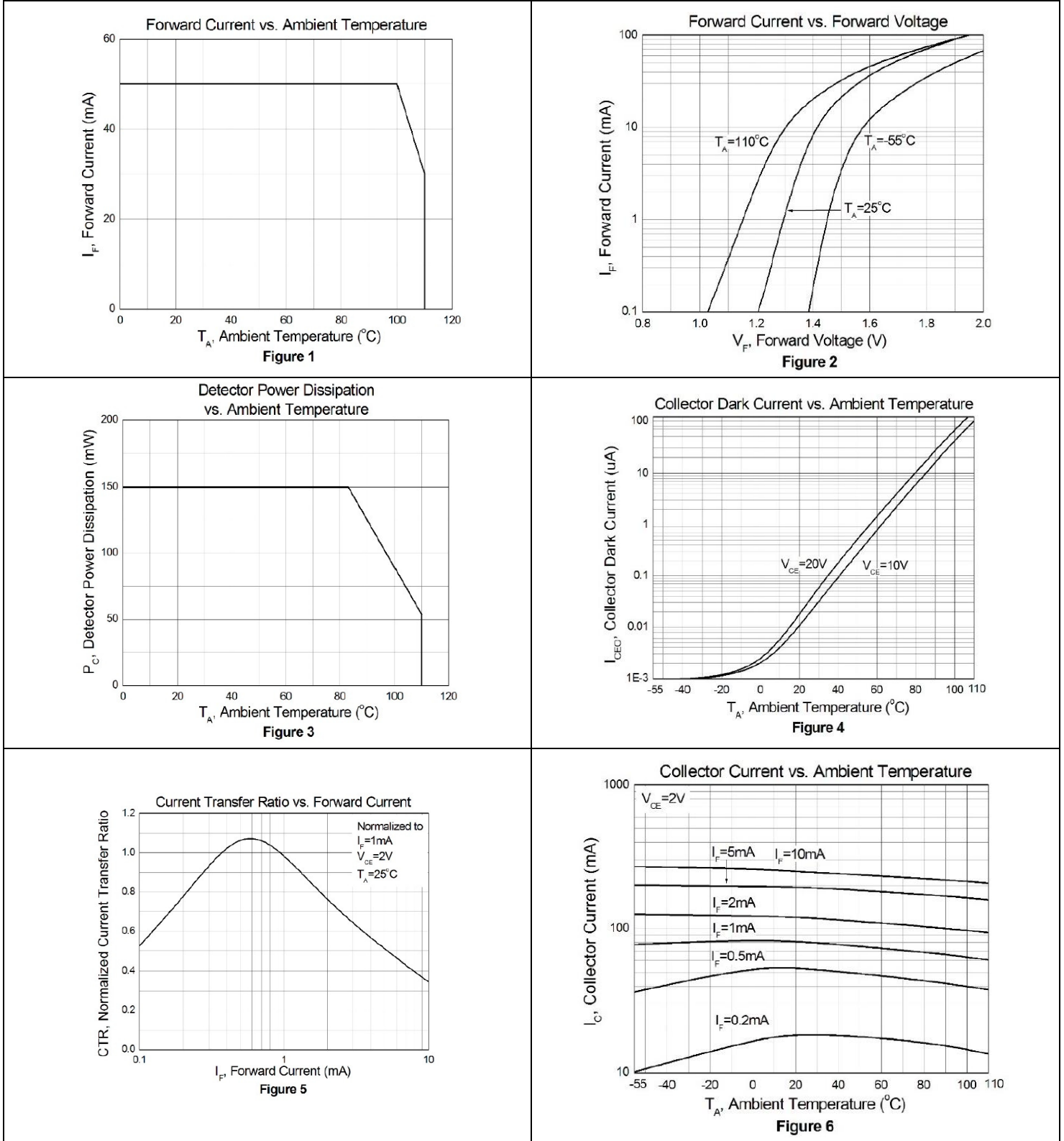

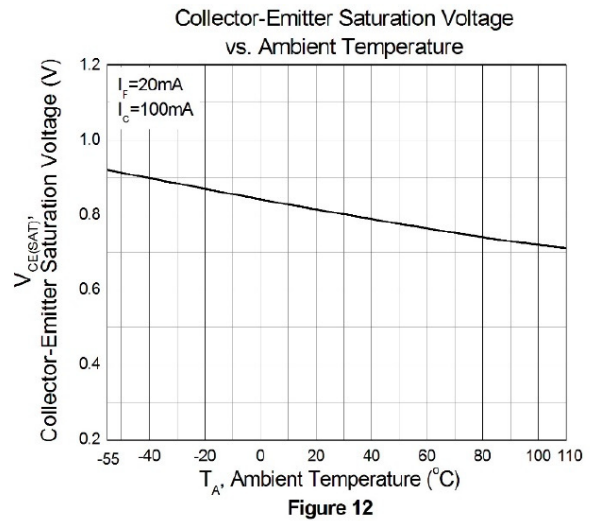
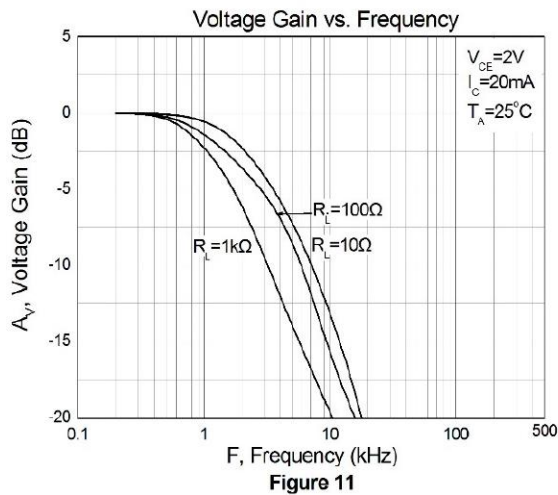
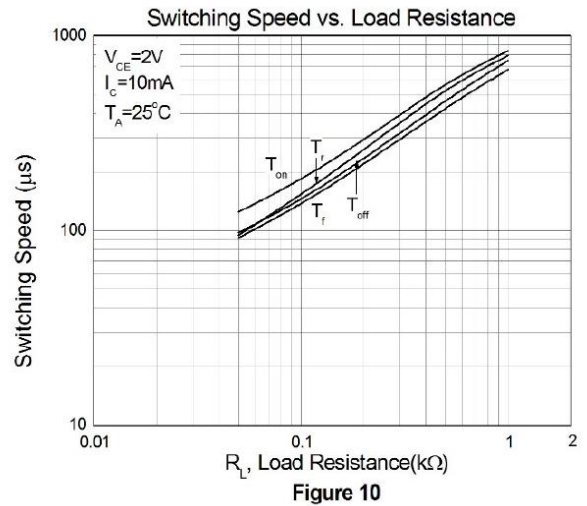
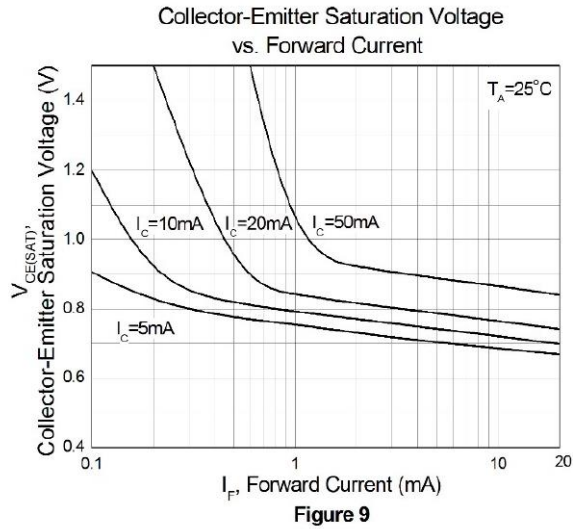
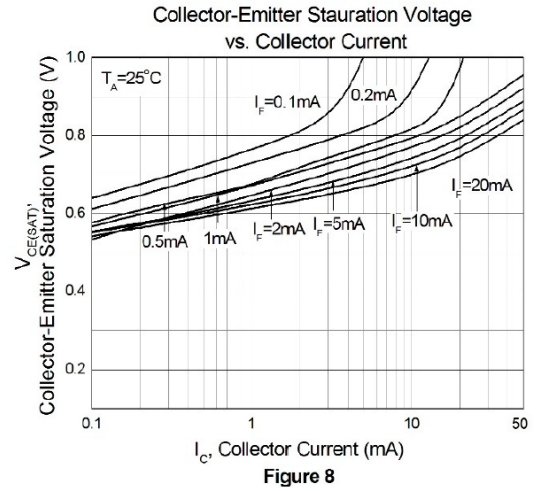
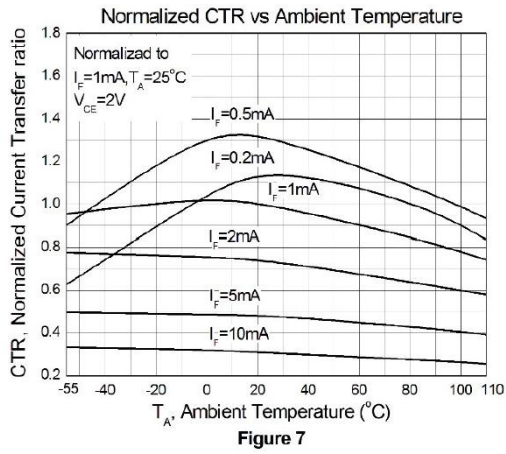

Solder Profile & Footprint

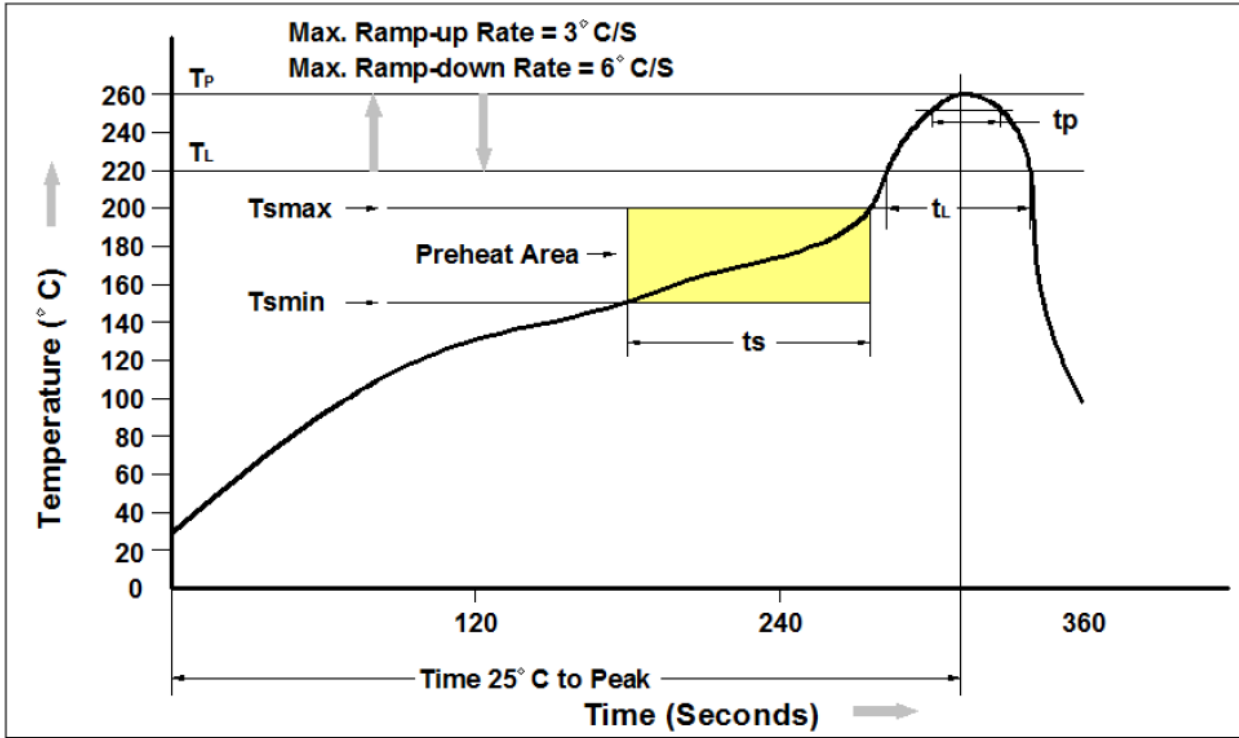

Profile Feature	Pb-Free Assembly Profile
Temperature Min. (T _{smin})	150°C
Temperature Max. (T _{smax})	200°C
Time (t _s) from (T _{smin} to T _{smax})	60-120 seconds
Ramp-up Rate (t _L to t _p)	3°C/second max.
Liquidous Temperature (T _L)	217°C
Time (t _L) Maintained Above (T _L)	60 – 150 seconds
Peak Body Package Temperature	260°C +0°C / -5°C
Time (t _p) within 5°C of 260°C	30 seconds
Ramp-down Rate (T _P to T _L)	6°C/second max
Time 25°C to Peak Temperature	8 minutes max.

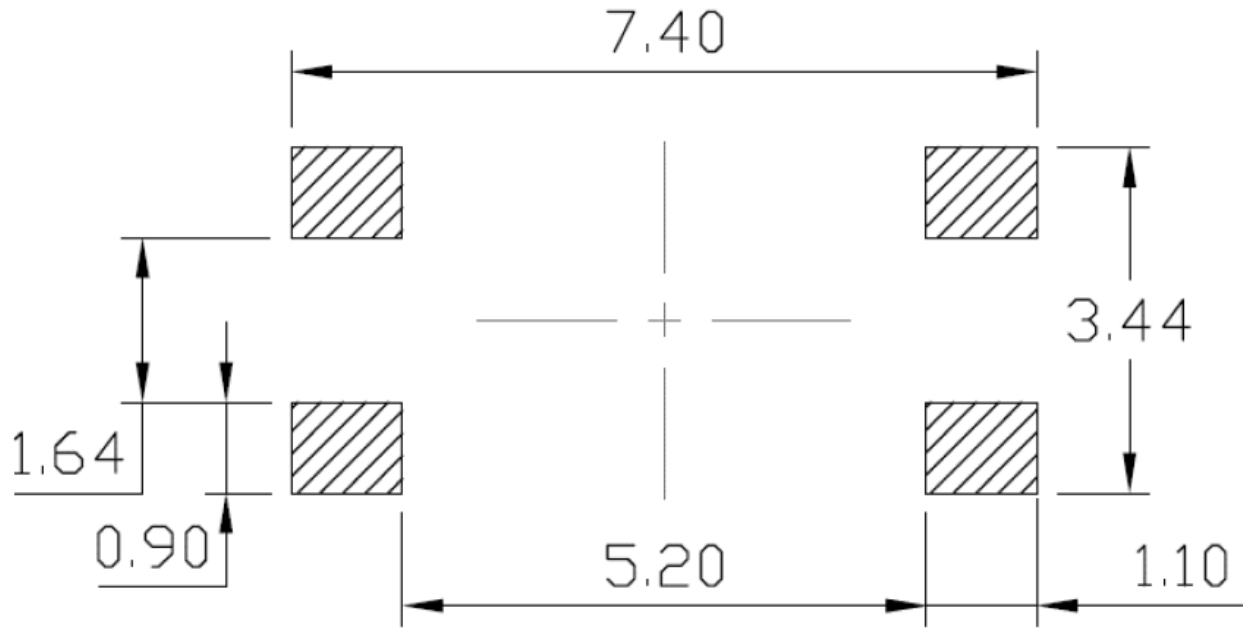

Recommended Solder Footprint for SMD Leadform

Units: mm

tolerance: +/- 0.1mm

Packing & Labeling**Tape Dimension:**

Option (T1)

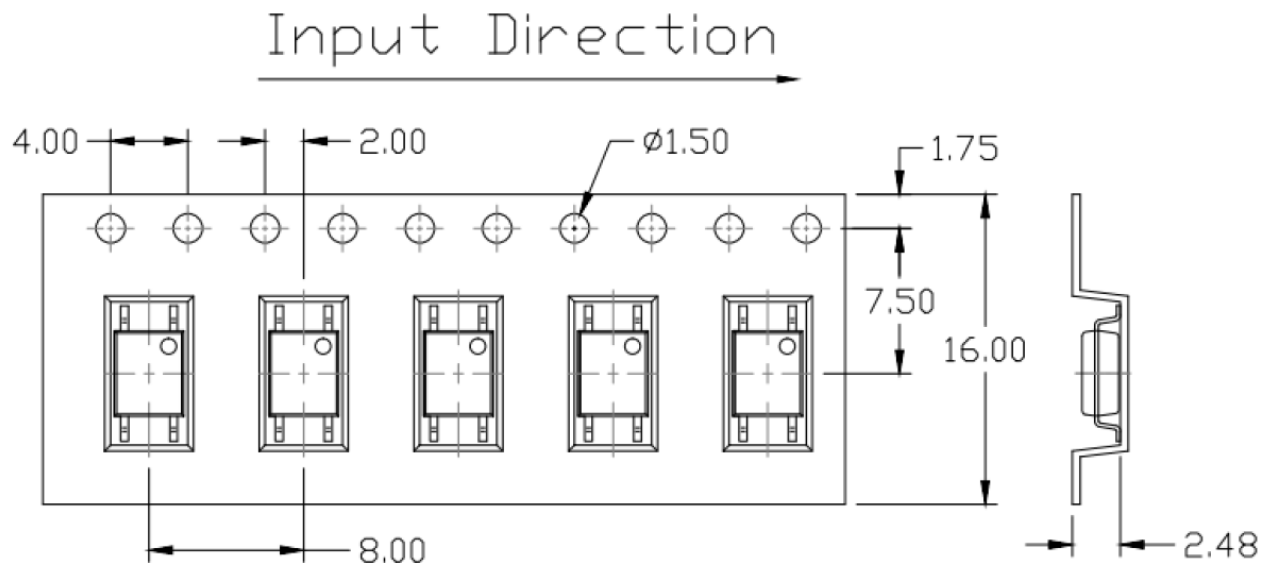

Option (T2)

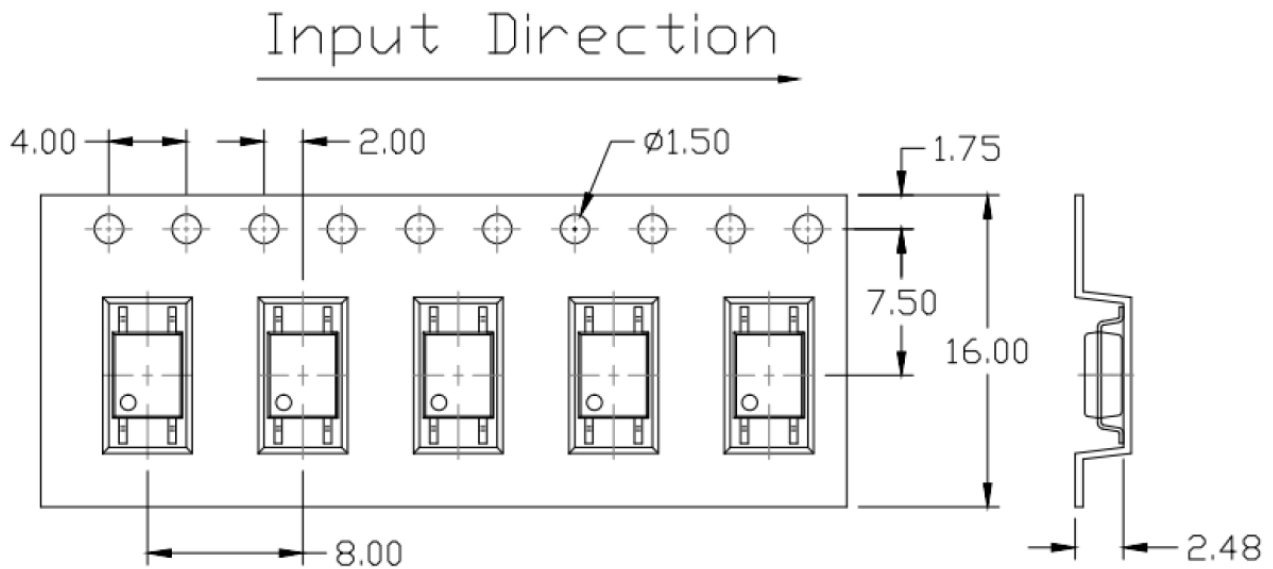

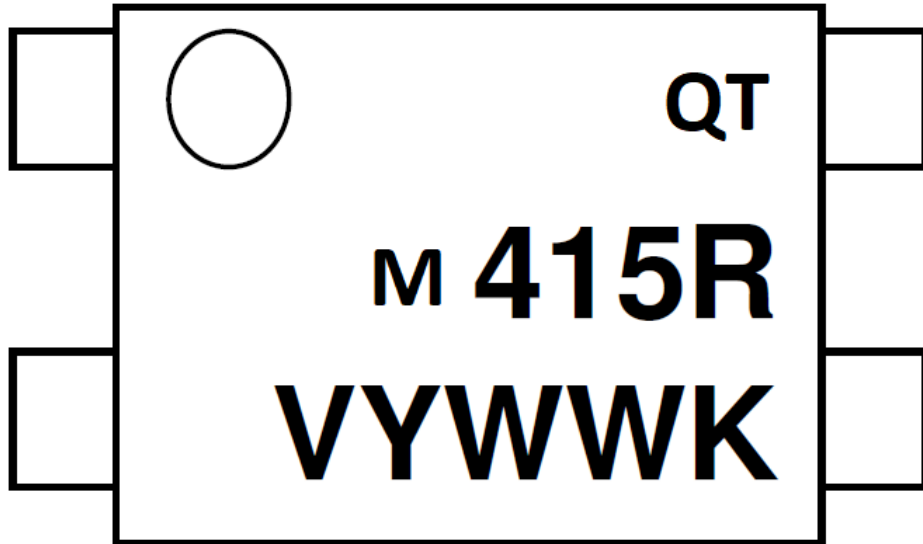
Device Marking

QT = QT-Brightek Corporation
 M= Mini-Flat Package
 415 = part number
 R= CTR Rank
 Y = Year
 WW = Week
 V = VDE Option
 K= Manufacturing code

Ordering Information

QTM415X(V)(Z)
 X = Part number (X=A,B or None)
 V = VDE option (V or None)
 Z = Tape and reel option (T1 or T2)

Option	Description	Quantity
T1	Surface Mount Lead Forming – with Option 1 Taping	3000 pcs/ reel
T2	Surface Mount Lead Forming – with Option 2 Taping	3000 pcs/ reel

Product: QTM415	Date: April 13, 2018	Page 11 of 12
	Version# 1.1	



Revision History

Description:	Revision #	Revision Date
Initial release of QTM415	1.0	02/08/2018
Amend the Marking	1.1	04/13/2018

Disclaimer

QT-BRIGHTEK reserves the right to make changes without further notice to any products herein to improve reliability, function or design. QT-BRIGHTEK does not assume any liability arising out of the application or use of any product or circuit described herein; neither does it convey any license under its patent rights, nor the rights of others.

Life Support Policy

QT-BRIGHTEK’s products are not authorized for use as critical components in life support devices or systems without the express written approval of QT-BRIGHTEK. As used herein:

1. Life support devices or systems are devices or systems which, (a) are intended for surgical implant into the body, or (b) support or sustain life, and (c) whose failure to perform when properly used in accordance with instructions for use provided in the labeling, can be reasonably expected to result in a significant injury of the user.
2. A critical component in any component of a life support device or system whose failure to perform can be reasonably expected to cause the failure of the life support device or system, or to affect its safety or effectiveness.