

GlobTek, Inc.
 www.globtek.com
 186 Veterans Drive,
 Northvale, NJ 07647
 Tel. (201) 784-1000
 Fax (201) 784-0111

Drawing Title: GTM96180-1807-2.0-T3, ITE / Medical Power Supply/Class 2/Household Power Supply, Efficiency Level: VI, Case Color/Style: GlobTek Black, Desktop/External, Regulated Switchmode AC-DC Power Supply AC Adaptor, Input Rating: 100-240V~, 50-60 Hz, IEC 60320/C14 , Output Rating: 18W, 5V@3.6A, Output Configuration: 1200 mm, 18/1C + Shield Cond, UL 1185, USB Type-C Connector, Ferrite: None, GlobTek Black, GT Cord # C7462, Pin Out: Per customer requirement, no pin out marked on the label, Blades/Input Cord: (Order Separately), Approvals: Taiwan BSMI IP42 CB CB Class I 230V CoC Tier 2 cUL Korea (12V Only) CE NOM S-Mark ETL CCC CE IRAM CB cETLus UL1310 CE China RoHS Level VI LPS RoHS Ukraine VCCI WEEE PSE PSE FCC CAN ICES-3 cETLus cETLus 60601-1 3rd CB RCM

Model No. GTM96180-1807-2.0-T3

Part No./Ordering No. TR9CA3600USBC-IMR6B

Rev A

REVISION HISTORY

REV	DESCRIPTION	SUB	DATE	APPROVED
A	INITIAL RELEASE	DR	03/26/2018	QA

In Addition to GlobTek Inc.'s renewed ISO9001:2008 - Quality Management System Certification, GlobTek Inc. is now certified to:

ISO13485:2003 - Medical Devices Quality Management System Certification
 ISO14001:2004 - Environmental Management System Certification

ISO Certificates are available online at <http://www.globtek.com/iso-certificates/>

Customer Approval of Specification:

Please approve, sign and send back to GlobTek so we can complete order processing.

A delay in receipt of this form will delay delivery schedule.

Company Name:

Customer P/N:

Quote Number:

Date:

Authorized Representative Name:

Authorized Representative Signature:

The acceptance of this specification and use of the product described in this document indicates the acceptance and binding of the customer to Globtek terms and conditions, which supersede all other agreements, terms, and conditions (<http://en.globtek.com/terms-and-conditions/>).

Footnote:

GlobTek Inc. will not be liable for the safety and performance of these power supplies if unauthorized access and repair occurs. End user should consult applicable UL, CSA or EN standards for proper installation instruction.

Limitation of Use:

GlobTek product are not authorized for use as mission critical components in life support hazardous environment, nuclear or aircraft applications without prior written approval from the CEO of GlobTek Inc.

Contents of this document are subject to change without prior notice.

GTM96180-1807-2.0-T3, 18W, 5V@3.6A, Desktop/External, Regulated Switchmode AC-DC Power Supply AC Adaptor

PROPRIETARY INFORMATION

PROPRIETARY OF GLOBTEK, INC. ANY REPRODUCTION, DISCLOSURE OR USE OF THIS DRAWING, IN WHOLE OR IN PART, IS HEREBY PROHIBITED EXCEPT AS SPECIFIED IN WRITING BY GLOBTEK, INC.

GlobTek, Inc.
www.globtek.com
186 Veterans Drive,
Northvale, NJ 07647
Tel. (201) 784-1000
Fax (201) 784-0111

Drawing Title: GTM96180-1807-2.0-T3, ITE / Medical Power Supply/Class 2/Household Power Supply, Efficiency Level: VI, Case Color/Style: GlobTek Black, Desktop/External, Regulated Switchmode AC-DC Power Supply AC Adaptor, Input Rating: 100-240V~, 50-60 Hz, IEC 60320/C14 , Output Rating: 18W, 5V@3.6A, Output Configuration: 1200 mm, 18/1C + Shield Cond, UL 1185, USB Type-C Connector, Ferrite: None, GlobTek Black, GT Cord # C7462, Pin Out: Per customer requirement, no pin out marked on the label, Blades/Input Cord: (Order Separately), Approvals: Taiwan BSMI IP42 CB CB Class I 230V CoC Tier 2 cUL Korea (12V Only) CE NOM S-Mark ETL CCC CE IRAM CB cETLus UL1310 CE China RoHS Level VI LPS RoHS Ukraine VCCI WEEE PSE PSE FCC CAN ICES-3 cETLus cETLus 60601-1 3rd CB RCM

Model No. GTM96180-1807-2.0-T3

Part No./Ordering No. TR9CA3600USBC-IMR6B

Rev A

POWER SUPPLY INFORMATION

TYPE: Desktop/External
TECHNOLOGY: Regulated Switchmode AC-DC Power Supply AC Adaptor
CASE COLOR: GlobTek Black
NAMEPLATE RATED INPUT: 100-240V~, 50-60 Hz, 0.6 A
INPUT CONFIG: IEC 60320/C14
WATTS: 18.0
VOLTS OUT: 5
CURRENT OUT (Amps): 3.6
BLADE/CORD INCLUDED: None:
BLADE/CORD INSTALLED: None:
GROUNDING CONFIGURATION (F2) Isolated Functional Earth for GTM96 series, Improved EMC
EFFICIENCY LEVEL: VI
OUTPUT CONFIGURATION 1200 mm, 18/1C + Shield Cond, UL 1185, USB Type-C Connector, Ferrite: None, GlobTek Black, GT Cord # C7462
CONNECTOR PIN OUT: Per customer requirement, no pin out marked on the label
LABEL SPECS: Standard GT,L-1186
PACK SPEC: Standard DT, Cellular packaging

Notes/Modifications/Customizations (notes in this section supersede the values shown in the standard spec):

DIMENSIONS ARE IN MM UNLESS SPECIFIED OTHERWISE.

GlobTek, Inc. www.globtek.com 186 Veterans Drive, Northvale, NJ 07647 Tel. (201) 784-1000 Fax (201) 784-0111	Drawing Title: GTM96180-1807-2.0-T3, ITE / Medical Power Supply/Class 2/Household Power Supply, Efficiency Level: VI, Case Color/Style: GlobTek Black, Desktop/External, Regulated Switchmode AC-DC Power Supply AC Adaptor, Input Rating: 100-240V~, 50-60 Hz, IEC 60320/C14 , Output Rating: 18W, 5V@3.6A, Output Configuration: 1200 mm, 18/1C + Shield Cond, UL 1185, USB Type-C Connector, Ferrite: None, GlobTek Black, GT Cord # C7462, Pin Out: Per customer requirement, no pin out marked on the label, Blades/Input Cord: (Order Separately), Approvals: Taiwan BSMI IP42 CB CB Class I 230V CoC Tier 2 cUL Korea (12V Only) CE NOM S-Mark ETL CCC CE IRAM CB cETLus UL1310 CE China RoHS Level VI LPS RoHS Ukraine VCCI WEEE PSE PSE FCC CAN ICES-3 cETLus cETLus 60601-1 3rd CB RCM	
	Model No. GTM96180-1807-2.0-T3	
	Part No./Ordering No. TR9CA3600USBC-IMR6B	Rev A

ELECTRICAL SPECIFICATIONS

A) ELECTRICAL SPECIFICATIONS:

01. Input Voltage: Specified 90-264 Vac, Nameplate rated: 100-240Vac
 - 90-264 Vac range @ 100% of rated load current
 - 85-264 Vac range @ 85% of rated load current
 - 110-370 VDC range @ 100% of rated load current
02. Input Frequency: Specified 47-63 Hz, Nameplate rated 50-60Hz
03. Output Regulation: +/- 5% measured at the output connector
04. Line Voltage Regulation: +/- 0.5% typical measured at full load
05. Green Power On Indicator LED
06. Output Ripple (Vp-p): 1% or 100 mV whichever is greater, measured at 20 MHz bandwidth with 0.1 uf ceramic capacitor in parallel with a low impedance 47 uf electrolytic capacitor connected at the end of the output connector
07. Turn-ON/OFF Overshoot: 5% maximum, 1 mS typical recovery time for 40% to 70% step load
08. Turn-ON Delay: 1 second maximum @ full load, nominal line
09. Hold-Up Time: 8 mS typical @ nominal input voltage and full load
10. Inrush Current: 30A/60A maximum cold start @ 115/230Vac input
11. Efficiency: Compliant with Efficiency Level VI and CoC Tier 2 standards
12. No Load Standby Power: <0.075 W @ 230Vac

B) PROTECTION

01. Input Protection: Input line fusing and 300Vac MOV
02. Short Circuit/ Overload: Electronically Protected unit will auto recover upon removal of fault
 - Output Current Limit: 110% to 160% of rated output current
 - (upper end of current limit range is determined by normal output power rating, not derated output power level)
03. Output Over-Voltage: 110% to 130% of nominal output voltage

C) SAFETY

01. Dielectric Withstand Voltage: 4000Vac or 5656Vdc from input to output, On Class I models, 3000Vac or 4242Vdc from input to earth
02. Earth Leakage Current: Class I models < 300uA, N/A for Class II models
03. Touch Current: Class I models < 20uA, Class II models < 75uA
04. Output Floating or Earthed option for Class I desktop models.
 - See [Output Isolation Options](#) for details
05. Earth Continuity Test: < 0.1 Ohm between Earth Pin at AC input and PCB termination point (Class I models only)
06. Means of Protection: 2 x MOPP
07. Compliant Standards: See listings at end of this drawing for specifics

D) EMC

- EN 60601-1-2, 4th edition
 Emissions, per EN 55032, EN 61000-6-3, EN 61000-6-4
 Conducted Emissions: Class B, FCC Part 15, Class B
 Radiated Emissions: Class B, FCC Part 15, Class B
 Line Frequency Harmonics EN61000-3-2, Class A
 Voltage Fluctuations/Flicker EN61000-3-3

- Immunity, per EN 55024, EN 61000-6-1, EN 61000-6-2
 Static Discharge Immunity EN61000-4-2, 10kV Contact Discharge, 20kV air discharge
 Radiated RF Immunity EN61000-4-3, 10V/m 80-1000MHz, 3V/m 1-2.7GHz, 80% 1KHz AM.
 EFT/Burst Immunity EN61000-4-4, 4kV/100kHz.
 Line Surge Immunity EN61000-4-5, 2kV differential, 4kV common-mode
 Conducted RF Immunity EN61000-4-6, 3Vrms, 80% 1KHz AM
 Power Frequency Magnetic Field Immunity EN61000-4-8, 3A/m
 Voltage Dip Immunity EN61000-4-11, Criteria

E) OTHER:

01. MTBF: 1,000,000 Hours @ 40°C ambient temperature, Full Load
02. Operating Temperature: -20°C to 40°C ambient temperature at full load, -40°C to 50°C ambient temperature with derating to 80% load
03. Operating Humidity: 0% to 95% relative humidity, non-condensing
04. Storage Temperature: -30°C to 80°C
05. Operating Altitude: 5000 Meters

PROPRIETARY INFORMATION

PROPRIETARY OF GLOBTEK, INC. ANY REPRODUCTION, DISCLOSURE OR USE OF THIS DRAWING, IN WHOLE OR IN PART, IS HEREBY PROHIBITED EXCEPT AS SPECIFIED IN WRITING BY GLOBTEK, INC.

quest /08/20/2018 7:42:43 AM

GlobTek, Inc.
 www.globtek.com
 186 Veterans Drive,
 Northvale, NJ 07647
 Tel. (201) 784-1000
 Fax (201) 784-0111

Drawing Title: GTM96180-1807-2.0-T3, ITE / Medical Power Supply/Class 2/Household Power Supply, Efficiency Level: VI, Case Color/Style: GlobTek Black, Desktop/External, Regulated Switchmode AC-DC Power Supply AC Adaptor, Input Rating: 100-240V~, 50-60 Hz, IEC 60320/C14 , Output Rating: 18W, 5V@3.6A, Output Configuration: 1200 mm, 18/1C + Shield Cond, UL 1185, USB Type-C Connector, Ferrite: None, GlobTek Black, GT Cord # C7462, Pin Out: Per customer requirement, no pin out marked on the label, Blades/Input Cord: (Order Separately), Approvals: Taiwan BSMI IP42 CB CB Class I 230V CoC Tier 2 cUL Korea (12V Only) CE NOM S-Mark ETL CCC CE IRAM CB cETLus UL1310 CE China RoHS Level VI LPS RoHS Ukraine VCCI WEEE PSE PSE FCC CAN ICES-3 cETLus cETLus 60601-1 3rd CB RCM

Model No. GTM96180-1807-2.0-T3

Part No./Ordering No. TR9CA3600USBC-IMR6B

Rev A

- 06. Ingress Protection: IP40 standard, IP52 available as special option
- 07. ROHS: Compliant with latest regulations, see approvals section below

F) ENCLOSURE

- 01. Housing: High impact plastic, 94V0 polycarbonate, non-vented
- 02. Markings: Label or Laser Printed
- 03. AC Input mechanical options: Class II Wall Plug-in, Changeable Blades Desktop Option, extended housing: C6, C8, C14 or C18 IEC Inlet.

G) SPECIAL OPTIONS

- 01. Cost reduction, removal of LED
 - 02. Custom Cordsets, various cordage types, and connector types*
 - 03. Custom Markings
 - 04. Short term Output Surge Capability
 - 05. Reduced Leakage Current versions (10uA max), for CF medical applications, and AC noise sensitive equipment, 15W or less, 5V to 24V output voltage range.
 - 06. Tightened output voltage tolerance
 - 07. Reduced output ripple level
 - 08. Reduced output power rating marking
 - 09. High Rel PCB laminate with Plated through Holes for IPC610 Class 2 Compliance
 - 10. Special Housing Colors and Cordset Colors
 - 11. Quasi Constant Current Output, for Lead-Acid Battery Charger Applications
- * 5Vdc USB output connector power supplies, which use the Micro-B or C-type style connector, have a max output voltage regulation specification of +/-8% (4.6V to 5.4V range).

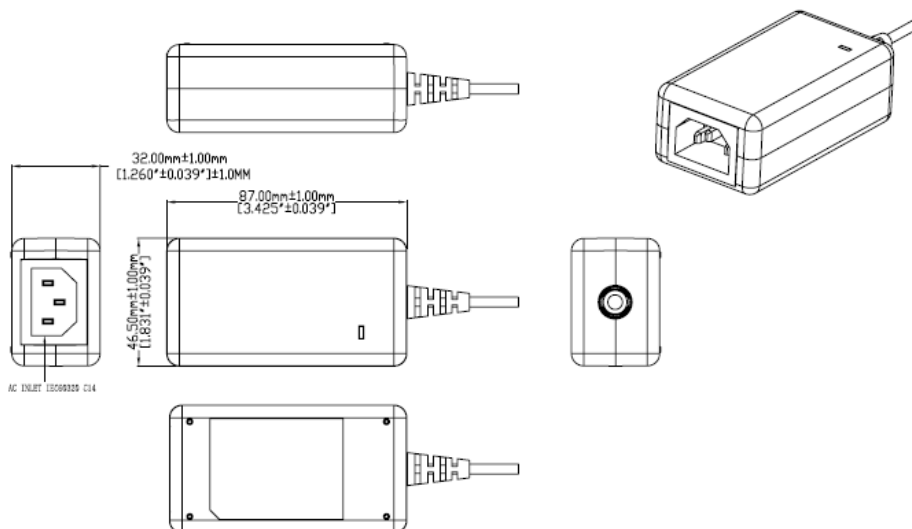

DERATING CURVE

GlobTek, Inc.
 www.globtek.com
 186 Veterans Drive,
 Northvale, NJ 07647
 Tel. (201) 784-1000
 Fax (201) 784-0111

Drawing Title: GTM96180-1807-2.0-T3, ITE / Medical Power Supply/Class 2/Household Power Supply, Efficiency Level: VI, Case Color/Style: GlobTek Black, Desktop/External, Regulated Switchmode AC-DC Power Supply AC Adaptor, Input Rating: 100-240V~, 50-60 Hz, IEC 60320/C14 , Output Rating: 18W, 5V@3.6A, Output Configuration: 1200 mm, 18/1C + Shield Cond, UL 1185, USB Type-C Connector, Ferrite: None, GlobTek Black, GT Cord # C7462, Pin Out: Per customer requirement, no pin out marked on the label, Blades/Input Cord: (Order Separately), Approvals: Taiwan BSMI IP42 CB CB Class I 230V CoC Tier 2 cUL Korea (12V Only) CE NOM S-Mark ETL CCC CE IRAM CB cETLus UL1310 CE China RoHS Level VI LPS RoHS Ukraine VCCI WEEE PSE PSE FCC CAN ICES-3 cETLus cETLus 60601-1 3rd CB RCM

Model No. GTM96180-1807-2.0-T3

Part No./Ordering No. TR9CA3600USBC-IMR6B

Rev A

TYPICAL EXTERNAL POWER SUPPLY DERATING CURVE

(FOR 18W AND 36W EFFICIENCY LEVEL VI PRODUCTS)

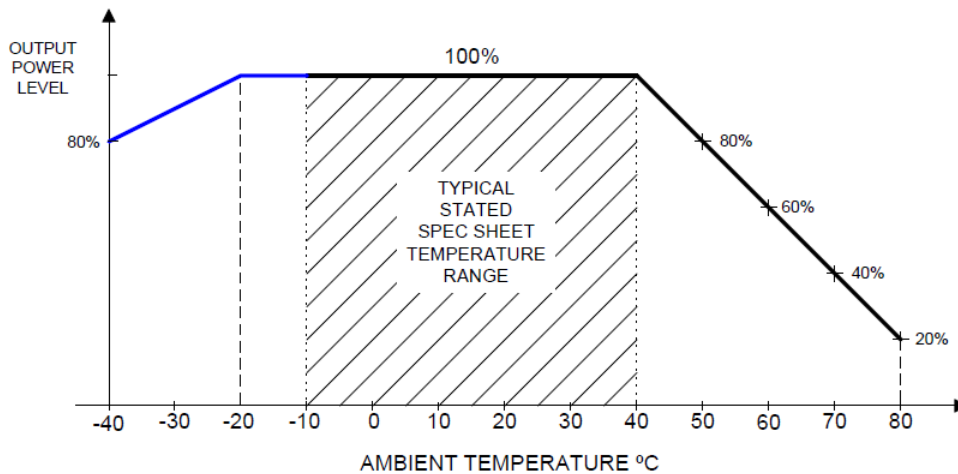

GlobTek, Inc.
 www.globtek.com
 186 Veterans Drive,
 Northvale, NJ 07647
 Tel. (201) 784-1000
 Fax (201) 784-0111

Drawing Title: GTM96180-1807-2.0-T3, ITE / Medical Power Supply/Class 2/Household Power Supply, Efficiency Level: VI, Case Color/Style: GlobTek Black, Desktop/External, Regulated Switchmode AC-DC Power Supply AC Adaptor, Input Rating: 100-240V~, 50-60 Hz, IEC 60320/C14 , Output Rating: 18W, 5V@3.6A, Output Configuration: 1200 mm, 18/1C + Shield Cond, UL 1185, USB Type-C Connector, Ferrite: None, GlobTek Black, GT Cord # C7462, Pin Out: Per customer requirement, no pin out marked on the label, Blades/Input Cord: (Order Separately), Approvals: Taiwan BSMI IP42 CB CB Class I 230V CoC Tier 2 cUL Korea (12V Only) CE NOM S-Mark ETL CCC CE IRAM CB cETLus UL1310 CE China RoHS Level VI LPS RoHS Ukraine VCCI WEEE PSE PSE FCC CAN ICES-3 cETLus cETLus 60601-1 3rd CB RCM

Model No. GTM96180-1807-2.0-T3

Part No./Ordering No. TR9CA3600USBC-IMR6B

Rev A

INPUT CONFIGURATION

Grounding Configuration:

Blades/Cord Included: None:

Blades/Cord Installed: None:

IEC 60320/C14 AC Inlet Connector, Class I, Earth Ground

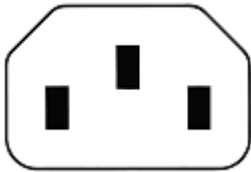

Mates with IEC 60320/C13 Plug

Optional Locking IEC60320 Receptacle and cord option available on some models by request.:



[Standard International IEC 320/C13 Cordsets](#)

Below are standard cordsets which are "not included" (unless stated above); these can be purchased separately or packaged with the power supply. Contact your Sales Engineer if the style required is not shown below. Many more available in different lengths, colors or cable material.

Stock Power Supply Cords

Part Number/ Link	Country	Plug	Termination	Length (mm)	(Ft)
3 Conductors (Grounded) IEC 320/C13					
3021457F701(R)	N. American	NEMA 5-15P	IEC 320/C13	2150	7
1191068F0701(R)	N. American	NEMA 5-15P Hospital	IEC 320/C13	2459	8
2194272M5701-T(R)	Argentina	IRAM 2073	IEC 320/C13	2500	8
5502022M5701A(R)	Australian	AS3112 / 3 PRONG	IEC 320/C13	2500	8
204B4272M5701(R)	Brazil	BRAZILIAN; WS-002	IEC 320/C13	2500	8

PROPRIETARY INFORMATION

PROPRIETARY OF GLOBTEK, INC. ANY REPRODUCTION, DISCLOSURE OR USE OF THIS DRAWING, IN WHOLE OR IN PART, IS HEREBY PROHIBITED EXCEPT AS SPECIFIED IN WRITING BY GLOBTEK, INC.

quest /08/20/2018 7:42:43 AM

GlobTek, Inc. www.globtek.com 186 Veterans Drive, Northvale, NJ 07647 Tel. (201) 784-1000 Fax (201) 784-0111	Drawing Title: GTM96180-1807-2.0-T3, ITE / Medical Power Supply/Class 2/Household Power Supply, Efficiency Level: VI, Case Color/Style: GlobTek Black, Desktop/External, Regulated Switchmode AC-DC Power Supply AC Adaptor, Input Rating: 100-240V~, 50-60 Hz, IEC 60320/C14 , Output Rating: 18W, 5V@3.6A, Output Configuration: 1200 mm, 18/1C + Shield Cond, UL 1185, USB Type-C Connector, Ferrite: None, GlobTek Black, GT Cord # C7462, Pin Out: Per customer requirement, no pin out marked on the label, Blades/Input Cord: (Order Separately), Approvals: Taiwan BSMI IP42 CB CB Class I 230V CoC Tier 2 cUL Korea (12V Only) CE NOM S-Mark ETL CCC CE IRAM CB cETLus UL1310 CE China RoHS Level VI LPS RoHS Ukraine VCCI WEEE PSE PSE FCC CAN ICES-3 cETLus cETLus 60601-1 3rd CB RCM	
	Model No. GTM96180-1807-2.0-T3	
	Part No./Ordering No. TR9CA3600USBC-IMR6B	Rev A

6023602M5701(R)	China	CCC GR2099	IEC 320/C13	2500	8
G8014272M5701(R)	Danish	AFSNIT SECTION 107-2-D1	IEC 320/C13	2500	8
23144272M5701-T(R)	Europe	CEE 7/7	IEC 320/C13	2500	8
2084272M5701(R)	India	India IS 1293 (also known as IA16A3 or BS546)	IEC 320/C13	2500	8
377C4272M5701(R)	Israel	ISL 377C	IEC 320/C13	2500	8
23024272M5701(R)	Italy	CEI 23-16/VII	IEC 320/C13	2500	8
3003339F701(R) [3x1.25mm2] 3003068F2701-HK(R) [3 x 2.0mm2]	Japan	JIS 8303 / 3 PINS	IEC 320/C13	2500	8
2313K3432M5701(R)	Korea	KS C 8305	IEC 320/C13	2500	8
23144272M5701-T(R) [Same as Europe Above]	Russia	GOST 7396	IEC 320/C13	2500	8
2084272M5701(R)	S. Africa	S. African	IEC 320/C13	2500	8
23214272M5701(R)	Switzerland	SEV 1011 (EL 203)	IEC 320/C13	2500	8
3003322M5701(R)	Taiwan	BSMI	IEC 320/C13	2500	8
PZ0800100-2M5BK13H(R)	UK	BS 1363A	IEC 320/C13	2500	8
7055002M5701A(R)	International	IEC 320 C14-C13	IEC 320/C13	2500	8

GlobTek, Inc.
 www.globtek.com
 186 Veterans Drive,
 Northvale, NJ 07647
 Tel. (201) 784-1000
 Fax (201) 784-0111

Drawing Title: GTM96180-1807-2.0-T3, ITE / Medical Power Supply/Class 2/Household Power Supply, Efficiency Level: VI, Case Color/Style: GlobTek Black, Desktop/External, Regulated Switchmode AC-DC Power Supply AC Adaptor, Input Rating: 100-240V~, 50-60 Hz, IEC 60320/C14 , Output Rating: 18W, 5V@3.6A, Output Configuration: 1200 mm, 18/1C + Shield Cond, UL 1185, USB Type-C Connector, Ferrite: None, GlobTek Black, GT Cord # C7462, Pin Out: Per customer requirement, no pin out marked on the label, Blades/Input Cord: (Order Separately), Approvals: Taiwan BSMI IP42 CB CB Class I 230V CoC Tier 2 cUL Korea (12V Only) CE NOM S-Mark ETL CCC CE IRAM CB cETLus UL1310 CE China RoHS Level VI LPS RoHS Ukraine VCCI WEEE PSE PSE FCC CAN ICES-3 cETLus cETLus 60601-1 3rd CB RCM

Model No. GTM96180-1807-2.0-T3

Part No./Ordering No. TR9CA3600USBC-IMR6B

Rev A

OUTPUT CORD AND CONNECTOR: USBC31/C7462

ACTUAL CONNECTORS, OVERMOLDS, FERRITES MAY VARY SLIGHTLY FROM THE PICTURE BELOW

CABLE TYPE	UL 1185
CABLE LENGTH (mm)	1200
CABLE TOLERANCE (mm)	+150 -0
WIRE GAUGE (AWG)	18
CONDUCTORS	1C + Shield
HANK DIMENSION (mm)	80+/-10
CABLE / CONNECTOR OVERMOLD COLOR	GlobTek Black
FERRITE TYPE / DIMENSION	None
FERRITE # OF TURNS (Definition)	N/A
FERRITE DIMENSION FROM STRAIN RELIEF	N/A
FERRITE DIMENSION FROM PLUG	N/A
PLUG TYPE	USB Type-C Connector
OVER MOLD ORIENTATION	Straight
CONNECTOR PIN OUT:	Per customer requirement, no pin out marked on the label
ADDITIONAL REQUIREMENTS	

Link to Globtek USB-C Adaptive Power Delivery White Paper

<http://en.globtek.com/technical-articles/usb-type-c-connectors-and-adaptive-power-delivery-white-paper>

Overmold is changeable!

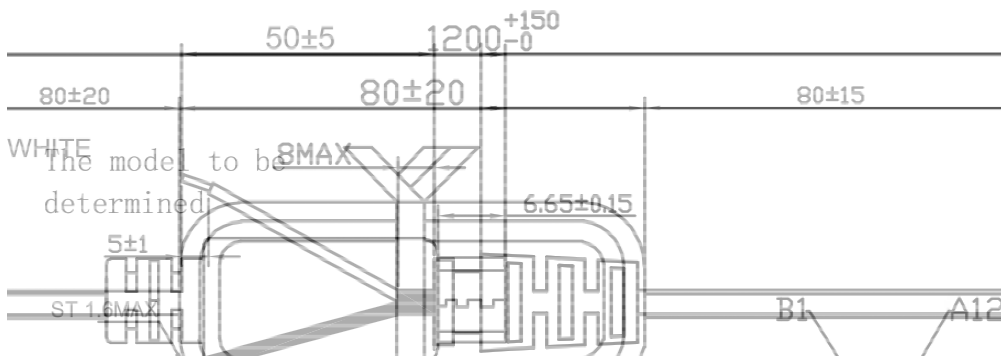

ADDITIONAL OUTPUT PLUG OPTIONS ARE AVAILABLE AT <http://www.globtek.com/connectors/>
 STANDARD PLUGS AND CONNECTORS CAN BE SEEN ONLINE AT <http://www.globtek.com/connectors/>

GlobTek, Inc.
 www.globtek.com
 186 Veterans Drive,
 Northvale, NJ 07647
 Tel. (201) 784-1000
 Fax (201) 784-0111

Drawing Title: GTM96180-1807-2.0-T3, ITE / Medical Power Supply/Class 2/Household Power Supply, Efficiency Level: VI, Case Color/Style: GlobTek Black, Desktop/External, Regulated Switchmode AC-DC Power Supply AC Adaptor, Input Rating: 100-240V~, 50-60 Hz, IEC 60320/C14 , Output Rating: 18W, 5V@3.6A, Output Configuration: 1200 mm, 18/1C + Shield Cond, UL 1185, USB Type-C Connector, Ferrite: None, GlobTek Black, GT Cord # C7462, Pin Out: Per customer requirement, no pin out marked on the label, Blades/Input Cord: (Order Separately), Approvals: Taiwan BSMI IP42 CB CB Class I 230V CoC Tier 2 cUL Korea (12V Only) CE NOM S-Mark ETL CCC CE IRAM CB cETLus UL1310 CE China RoHS Level VI LPS RoHS Ukraine VCCI WEEE PSE PSE FCC CAN ICES-3 cETLus cETLus 60601-1 3rd CB RCM

Model No. GTM96180-1807-2.0-T3

Part No./Ordering No. TR9CA3600USBC-IMR6B

Rev A

LABEL:L-1186

LABEL P/N: Standard GT
 MATERIAL: Flat Thermal Transfer, Imprintable, Polyester Label and/or Pad Printed and/or Molded, and/or Laser Engraved in the case
 BACKGROUND COLOR: Black if housing is Black, White or Silver if housing is White or Gray.
 TEXT COLOR: White or Silver if label is Black Background for Black housing. Black if label is White or Silver background and Housing is White or Gray
 LABEL WIDTH (mm): 36.5
 LABEL HEIGHT (mm): 48.5

Below is the minimum information which will appear on the label. NOTE: in the logo area additional/actual positioning of symbols and text is subjected to change as per agency updates/requirements or additional model approvals become available. Regulatory certifications/label markings may be in logo area on the label or molded into the case housing outside the label area. Information will be shown via label and/or pad printed and/or molded and/or laser engraved in the case. * Date code markings at GlobTek option.



↑
 XXX = USA or CHINA

DATE CODE A *:

DATE CODE LABEL



Series NO. Week Year
 Class NO. for production

or

DATE CODE B *:

WWYY
 WW = WEEK
 YY = YEAR

A=ITE / Medical Power Supply/Class 2/Household Power Supply
 B=P/N: (料号) TR9CA3600USBC-IMR6B
 C=Model (型号) GTM96180-1807-2.0-T3
 D=Input (输入) 100-240V~, 50-60 Hz, 0.6 A
 E=Output (输出) 5 V 3.6 A , 18.0W

- AGENCY ONLINE DOCUMENTS <http://www.globtek.info/certs/GTM96180-TZ/>
- CE EC-Declaration for Medical http://www.globtek.com/pdf/ec_declaration/a0Oa000000MmbDvEAJ
- CE EC-Declaration for Industrial/Commercial/ITE http://www.globtek.com/pdf/ec_declaration/a0Oa000000MmbDvEAJ
- RoHS/RoHS2 Declaration http://www.globtek.com/pdf/rohs_cert/01t0c000008OO4oAAG
- REACH Declaration http://www.globtek.com/pdf/iso_certificates/REACH.pdf

GlobTek, Inc.
www.globtek.com
186 Veterans Drive,
Northvale, NJ 07647
Tel. (201) 784-1000
Fax (201) 784-0111

Drawing Title: GTM96180-1807-2.0-T3, ITE / Medical Power Supply/Class 2/Household Power Supply, Efficiency Level: VI, Case Color/Style: GlobTek Black, Desktop/External, Regulated Switchmode AC-DC Power Supply AC Adaptor, Input Rating: 100-240V~, 50-60 Hz, IEC 60320/C14 , Output Rating: 18W, 5V@3.6A, Output Configuration: 1200 mm, 18/1C + Shield Cond, UL 1185, USB Type-C Connector, Ferrite: None, GlobTek Black, GT Cord # C7462, Pin Out: Per customer requirement, no pin out marked on the label, Blades/Input Cord: (Order Separately), Approvals: Taiwan BSMI IP42 CB CB Class I 230V CoC Tier 2 cUL Korea (12V Only) CE NOM S-Mark ETL CCC CE IRAM CB cETLus UL1310 CE China RoHS Level VI LPS RoHS Ukraine VCCI WEEE PSE PSE FCC CAN ICES-3 cETLus cETLus 60601-1 3rd CB RCM

Model No. GTM96180-1807-2.0-T3

Part No./Ordering No. TR9CA3600USBC-IMR6B

Rev A

Conflict Minerals Declaration

<http://www.globtek.com/pdf/conflict-minerals.pdf>

IPXY rating is based on 3rd party testing and customers should check suitability and test system level IPXY rating before ordering.

Regulatory Certifications/Label Markings

LATEST PRODUCT/MODEL CERTIFICATIONS: <http://en.globtek.com/datasheet/id/a00a000000MmbDv>

AGENCY ONLINE DOCUMENTS: <http://www.globtek.info/certs/GTM96180-TZ/>

Per customer requirement, no pin out marked on the label

GlobTek, Inc.
 www.globtek.com
 186 Veterans Drive,
 Northvale, NJ 07647
 Tel. (201) 784-1000
 Fax (201) 784-0111

Drawing Title: GTM96180-1807-2.0-T3, ITE / Medical Power Supply/Class 2/Household Power Supply, Efficiency Level: VI, Case Color/Style: GlobTek Black, Desktop/External, Regulated Switchmode AC-DC Power Supply AC Adaptor, Input Rating: 100-240V~, 50-60 Hz, IEC 60320/C14 , Output Rating: 18W, 5V@3.6A, Output Configuration: 1200 mm, 18/1C + Shield Cond, UL 1185, USB Type-C Connector, Ferrite: None, GlobTek Black, GT Cord # C7462, Pin Out: Per customer requirement, no pin out marked on the label, Blades/Input Cord: (Order Separately), Approvals: Taiwan BSMI IP42 CB CB Class I 230V CoC Tier 2 cUL Korea (12V Only) CE NOM S-Mark ETL CCC CE IRAM CB cETLus UL1310 CE China RoHS Level VI LPS RoHS Ukraine VCCI WEEE PSE PSE FCC CAN ICES-3 cETLus cETLus 60601-1 3rd CB RCM

Model No. GTM96180-1807-2.0-T3

Part No./Ordering No. TR9CA3600USBC-IMR6B

Rev A

PACKAGING

Packing Spec P/N: Standard DT, Cellular packaging
 Box Qty: 60
 Gift Box Size (mm): 147*100*33
 Gift Box Color: White
 Master Carton Size (mm): 480*450*205
 Master GW (Kg): 15.6 kg
 BLADES INCLUDED: None:
 BLADE/CORD INSTALLED: None:

If specific packaging is required, this section must specify all requirements and note "no exceptions". If this section does not specify packaging, it is subject to change without notice at GlobTek's discretion.

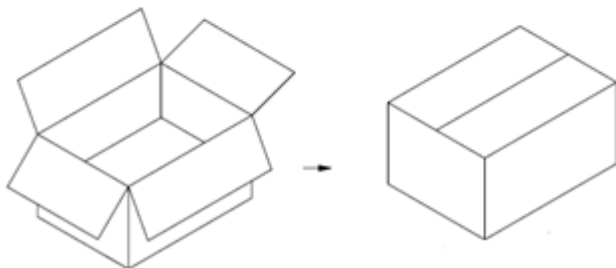
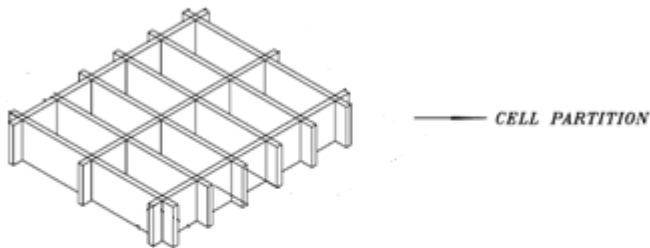
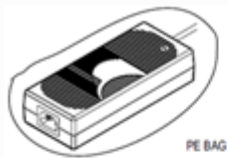

GlobTek, Inc.
www.globtek.com
186 Veterans Drive,
Northvale, NJ 07647
Tel. (201) 784-1000
Fax (201) 784-0111

Drawing Title: GTM96180-1807-2.0-T3, ITE / Medical Power Supply/Class 2/Household Power Supply, Efficiency Level: VI, Case Color/Style: GlobTek Black, Desktop/External, Regulated Switchmode AC-DC Power Supply AC Adaptor, Input Rating: 100-240V~, 50-60 Hz, IEC 60320/C14 , Output Rating: 18W, 5V@3.6A, Output Configuration: 1200 mm, 18/1C + Shield Cond, UL 1185, USB Type-C Connector, Ferrite: None, GlobTek Black, GT Cord # C7462, Pin Out: Per customer requirement, no pin out marked on the label, Blades/Input Cord: (Order Separately), Approvals: Taiwan BSMI IP42 CB CB Class I 230V CoC Tier 2 cUL Korea (12V Only) CE NOM S-Mark ETL CCC CE IRAM CB cETLus UL1310 CE China RoHS Level VI LPS RoHS Ukraine VCCI WEEE PSE PSE FCC CAN ICES-3 cETLus cETLus 60601-1 3rd CB RCM

Model No. GTM96180-1807-2.0-T3

Part No./Ordering No. TR9CA3600USBC-IMR6B

Rev A

INSTRUCTION SHEET

N/A