

16-Channel Power Supply System Featuring the LTM2987 Power System Manager

DESCRIPTION

The DC2023A is a demonstration system for the **LTM[®]2987** 16-channel I²C/SMBus/PMBus power system manager with EEPROM. The LTM2987 monitors and controls 16 power supply rails. The DC2023A demonstrates the ability of the LTM2987 to sequence, trim, margin, supervise, monitor, and log faults for 16 power supply rails. Each power supply channel's output voltage is monitored and the LTM2987 monitors its own internal die temperature.

The DC2023A is a single circuit board that contains sixteen independent power supply rails. The board employs sixteen LTC[®]3405A 300mA switch-mode regulators, which are configured to be controlled by the LTM2987. The LTM2987 is available in a μ Module[®] (micromodule) package and contains two LTC2977 devices. This board provides a sophisticated 16-channel digitally programmable power supply system. The rail voltages are programmable within the trim range shown in the Performance Summary.

This demonstration system is supported by the LTpowerPlay[™] graphical user interface (GUI) that enables complete control of all the features of the LTM2987. Together, the LTpowerPlay software and DC2023A hardware system create a powerful development environment for designing and testing LTM2987 configuration settings. These settings can be stored in the device's internal EEPROM or in a file. This file can later be used to order pre-programmed devices or to program devices in a production environment. The software displays all of the configuration settings and real time measurements from the LTM2987. Telemetry allows easy access and decoding of the fault log created by the LTM2987. The board comes pre-programmed with the EEPROM values appropriate for the sixteen power supplies used on the DC2023A. Just plug and play!

Multiple DC2023A board sets can be cascaded together to form a high channel count power supply (see Multi-Board Arrays). This cascaded configuration demonstrates features of the LTM2987 which enable timing and fault information to be shared across multiple ICs. The user can

configure up to eight DC2023A boards, thereby controlling up to 128 separate power supply rails. Larger arrays of LTM2987s are supported through programmable I²C base address or bus segmentation.

The DC2023A demo board can be powered by an external power supply, such as a +12VDC supply. Communication with the software is provided through the DC1613 USB-to-I²C/SMBus/PMBus Controller. The following is a checklist of items which can be obtained from the LTC website or LTC Field Sales.

- USB-to-I²C/SMBus/PMBus Controller (DC1613)
- LTpowerPlay Software

DC2023A Features

- Sequence, Trim, Margin, and Supervise Sixteen Power Supplies
- Manage Faults, Monitor Telemetry, and Create Fault Logs
- PMBus Compliant Command Set
- Supported by LTpowerPlay GUI
- Margin or Trim Supplies to 0.25% Accuracy
- Fast OV/UV Supervisors Per Channel
- Supports Multi-Channel Fault Management
- Automatic Fault Logging to Internal EEPROM
- Operates Autonomously without Additional Software
- Sixteen OV/UV V_{OUT} and Two V_{IN} Supervisors
- Telemetry Reads Back V_{IN}, V_{OUT}, and Temperature
- 16-Channel Time-Based Output Sequencer
- I²C/SMBus Serial Interface
- Integrated Decoupling Capacitors and Pull-Up Resistors
- Powered from 6V to 14VDC
- Available in 144-Lead 15mm × 15mm BGA

Design files for this circuit board are available at <http://www.linear.com/demo>

LT, LT, LTC, LTM, Linear Technology, the Linear logo and μ Module are registered trademarks and PowerPlay is a trademark of Linear Technology Corporation. All other trademarks are the property of their respective owners.

PERFORMANCE SUMMARY Specifications are at T_A = 25°C

POWER SUPPLY CHANNEL	CH(0:7)	CH(8:15)
Manager	1/2 LTM2987	1/2 LTM2987
Nominal Untrimmed Output Voltages	1.0V, 1.1V, 1.2V, 1.3V, 1.4V, 1.5V, 1.7V, 1.8V	2.0V, 2.2V, 2.5V, 2.7V, 3.0V, 3.1V, 3.2V, 3.3V
Rated Output Current	0.3A	
Default Margin Range	±5%	
Output Trim Range (V _{FS_VDAC} = 1.38V)	+13/-19 %	+11/-15%
Temperature	2 Internal	

Common Characteristics—Specifications Valid Over Full Operating Temperature Range

PARAMETER	CONDITIONS	VALUE			
		MIN	TYP	MAX	UNITS
Supply Input Voltage Range		6		14	V
ADC Total Unadjusted Error	V _{IN_ADC} ≥ 1V			±0.25	%
ADC Voltage Sensing Input Range	Differential Voltage: V _{IN_ADC} = (V _{SENSEP[n]} - V _{SENSEM[n]})	0		6	V

GLOSSARY OF TERMS

The following list contain terms used throughout the document.

Channel – The collection of functions that monitor, supervise, and trim a given power supply rail.

EEPROM – Non-volatile memory (NVM) storage used to retain data after power is removed.

Margin – Term used typically in board level testing that increases/decreases the output voltage to look for sensitivity/marginality problems

Monitor – The act of measuring voltage, current and temperature readings.

NVM – Non-volatile memory, see EEPROM.

PMBus – An industry standard power-management protocol with a fully defined command language that facilitates communication with power converters and other devices in a power system.

Rail – The final output voltage that the power supply controller manages.

Supervise – The act of quickly responding to a voltage, current, temperature condition that is compared to pre-programmed values (fault settings).

Trim – The act of adjusting the final output voltage. A servo loop is typically used to trim the voltage.

LTpowerPlay GUI SOFTWARE

LTpowerPlay is a powerful Windows-based development environment that supports Linear Technology Power System Management ICs with EEPROM, including the LTM2987 16-channel PMBus Power System Manager. The software supports a variety of different tasks. You can use LTpowerPlay to evaluate Linear Technology ICs by connecting to a demo board system. LTpowerPlay can also be used in an offline mode (with no hardware present) in order to build a multi-chip configuration file that can be saved and reloaded at a later time. LTpowerPlay provides unprecedented diagnostic and debug features. It becomes a valuable diagnostic tool during board bring-up to program or tweak the power management scheme in

a system or to diagnose power issues when bringing up rails. LTpowerPlay utilizes the DC1613 I²C/SMBus/PMBus Controller to communicate with one of many potential targets, including the DC2023A demo system or a customer board. The software also provides an automatic update feature to keep the software current with the latest set of device drivers and documentation. The LTpowerPlay software can be downloaded from:

<http://www.linear.com/ltpowerplay>

To access technical support documents for LTC power system management products visit Help, View Online Help on the LTpowerPlay menu.

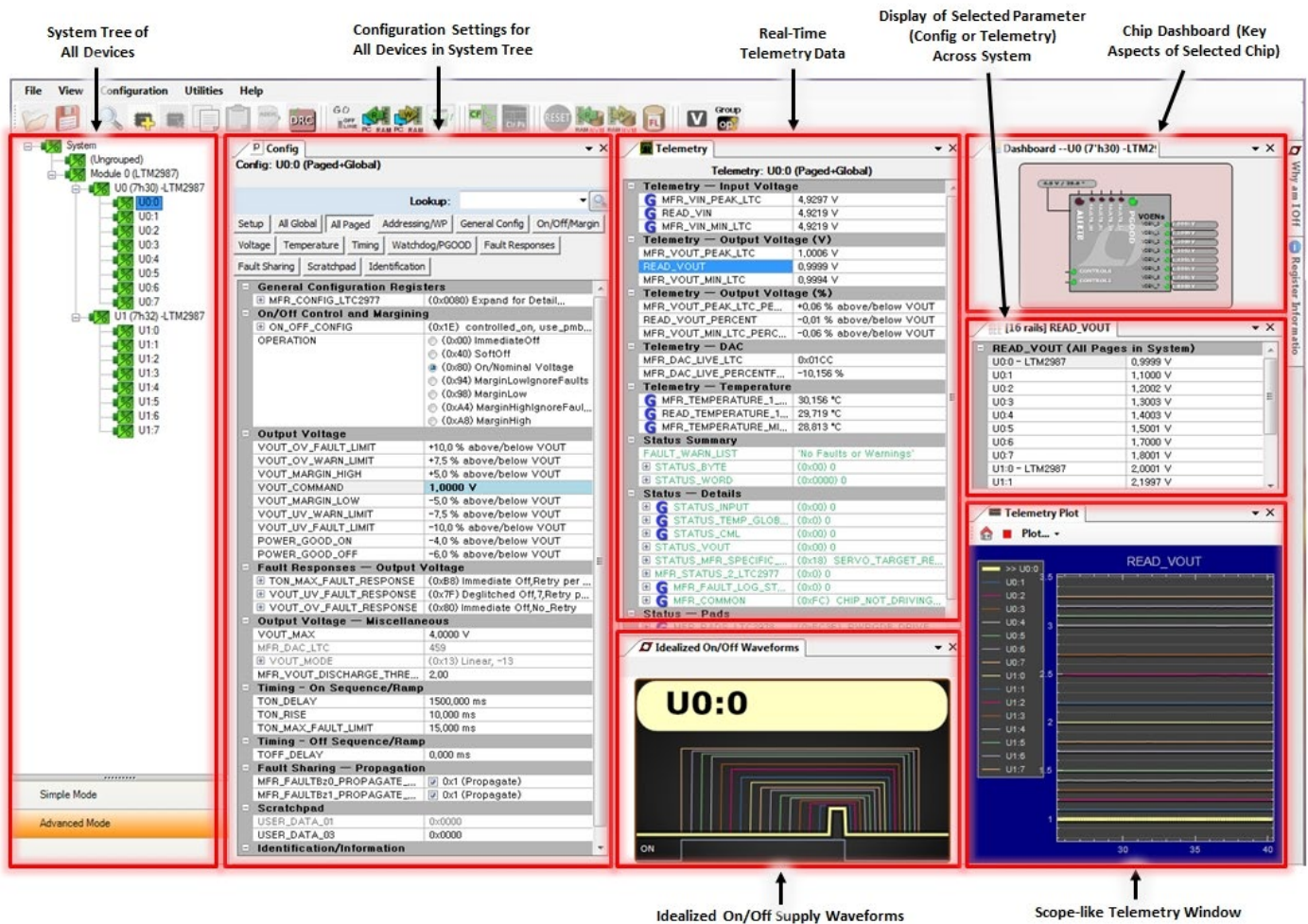

Figure 1. Screen Shot of the LTpowerPlay GUI

DEMO MANUAL DC2023A

QUICK START PROCEDURE

The following procedure describes how to set up a DC2023A demo system.

1. Download and install the LTpowerPlay GUI:

<http://www.linear.com/ltpowerplay>

2. Remove the board from the ESD protective bag and place it on a level surface. Connect the DC1613 I²C/SMBus/PMBus Controller to the DC2023A board using the 12-pin ribbon cable.
3. Confirm that the CONTROL switch is set to the RUN position.
4. Plug the USB to I²C/SMBus/PMBus Controller into a USB port on your PC. The board should power up with all power good LEDs and +5V LED illuminated green. The USB-to-I²C/SMBus/PMBus Controller supplies ~100mA of current which should be sufficient for a single demo board.
5. If multiple boards are being powered, connect a +12VDC power supply with > 0.5A capacity to the V_{IN} input jack of the DC2023A.

6. Launch the LTpowerPlay GUI.

- a. The GUI automatically identifies the DC2023A and builds a system tree. The system tree on the left hand side should look like this:

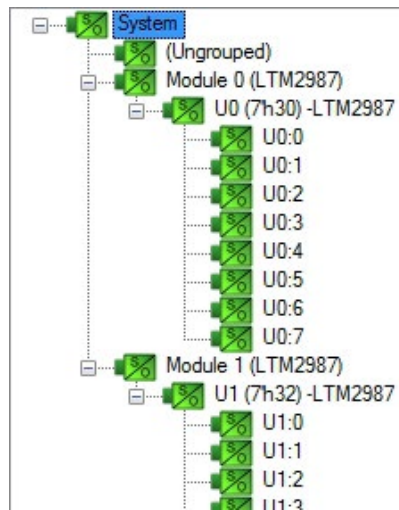

Note: For multiple board arrays, the GUI automatically ensures each device has a unique address. In this scenario, it is recommended at this point to store these addresses to NVM (EEPROM) by clicking the “RAM to NVM” icon in the toolbar.

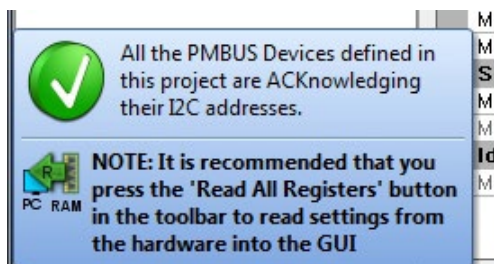

Figure 2. Connecting DC2023A board and the DC1613 I²C/SMBus/PMBus Controller

dc2023afa

QUICK START PROCEDURE

- b. A green message box will be displayed for a few seconds in the lower left hand corner confirming that the DC2023A is communicating:



- c. Save the demo board configuration to a (*.proj) file by clicking the "Save" icon. This creates a backup file. Name it whatever you want.

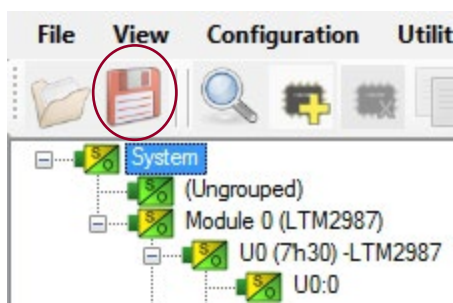

7. The CONTROL switch is configured to control all 16 channels. Slide the switch to RUN to enable, OFF to disable all channels. For multiple board arrays, the CONTROL switch is wired to a signal that is common across all boards. All CONTROL switches must be set to the RUN position to enable all boards.

Loading a DC2023A Configuration (*.Proj) File with the GUI

1. In the upper left hand corner of the GUI, File > Open > browse to your *.proj file. This will load the file into the GUI.
2. Click on the "Go Online" icon, then click on the "PC->RAM" arrow. This loads the configuration into the working RAM of the LTM2987.



3. To store the configuration to NVM (EEPROM), click on the "RAM->NVM" icon.

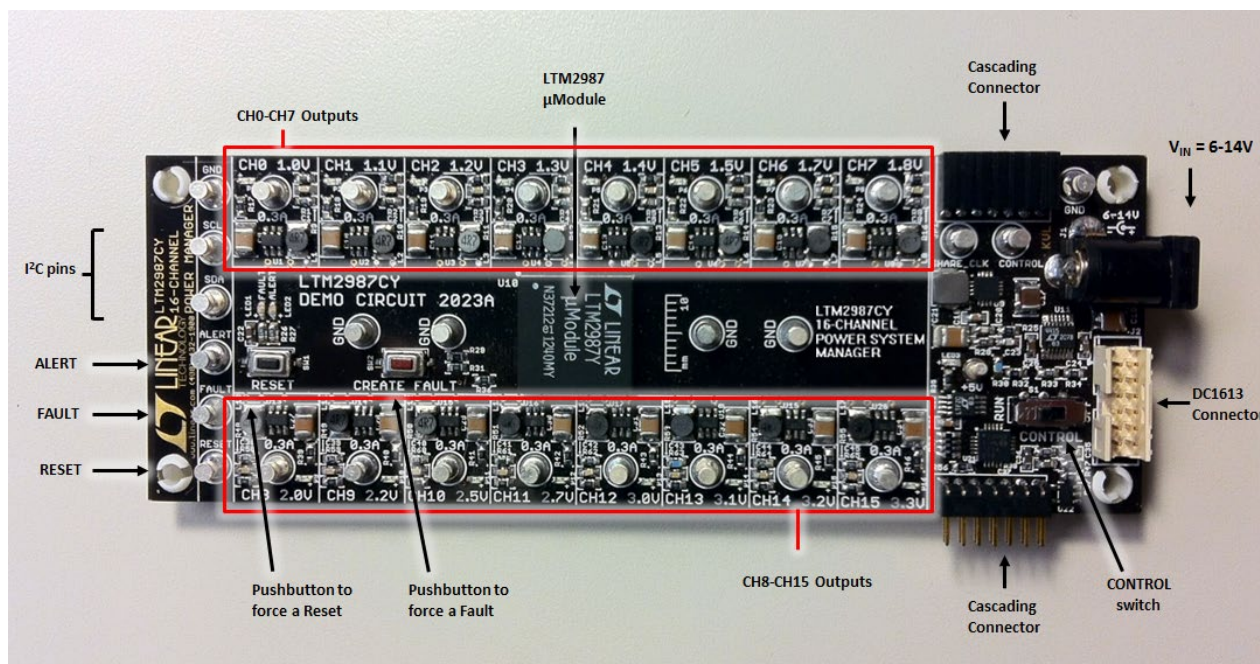
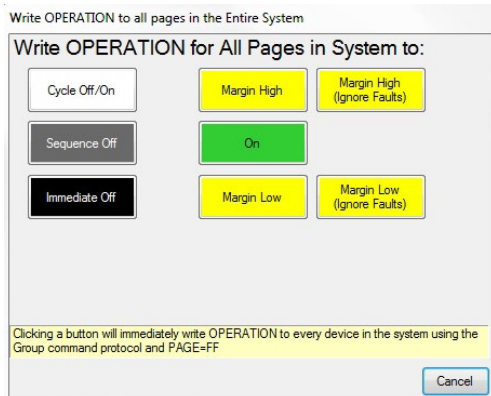

Figure 3. DC2023A Top Side Details

COMMON DEMO BOARD OPERATIONS

Margin All Rails

The LTM2987 power manager on the DC2023A not only monitors each of the sixteen outputs but can margin the outputs either high or low. Margining is the operation that moves a rail either up or down for testing purposes. It allows a system to be fully characterized over supply limits without the use of external hardware or resources. The GUI provides an easy way to margin all rails high or all low by clicking one of four buttons. To invoke the margining dialog, click the GroupOp icon in the toolbar. The buttons labeled “ignore faults” will margin without creating a fault even if the fault limits are exceeded.



A look at the telemetry window shows the effect of the margin high or margin low operation. The following screen shot shows all rails going from nominal set points to margin high, margin low, and back to nominal voltages.

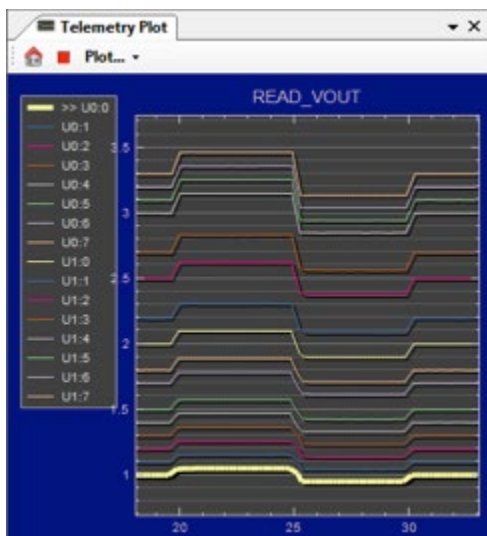

Each LTC2977 inside the module has a multiplexed ADC that is used to provide voltage, current, and temperature readback values. The telemetry plot in the GUI is similar to a multi-channel oscilloscope which is capable of displaying any parameter that is displayed in the telemetry window. Due to the nature of a multiplexed ADC converter, it has an associated ADC loop time. The total ADC loop time (~100ms to 160ms) for a given channel is dependent on the device’s configuration. Refer to the LTM2987 data sheet for complete ADC timing specifications.

Creating a Fault

There is a pushbutton on the DC2023A board that is used to force a fault and demonstrate the demo board’s ability to detect it and respond according to the configuration. When depressed, the pushbutton creates a fault on channel 10, the 2.5V output (GUI channel U1:2). The user should see all outputs power off, the fault LED momentarily illuminate, the alert LED illuminate continuously, and all rails sequence back on after a retry period. The user may also short any power supply output indefinitely. This is a good way to induce UV faults and shows that a shorted channel will not be damaged. Use a jumper wire or a coin to short any output.

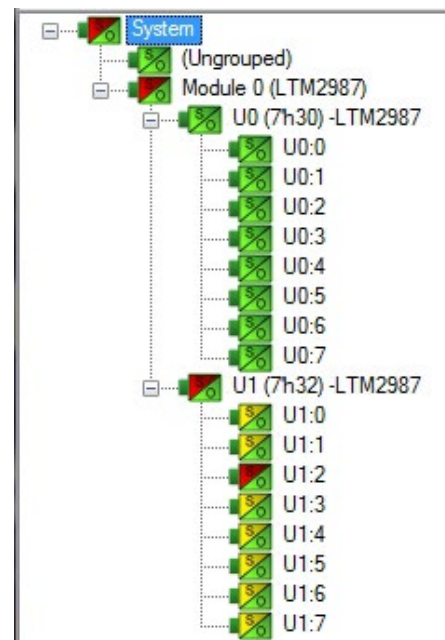

COMMON DEMO BOARD OPERATIONS

The LTM2987 has a feature which allows it to sequence its channels off in a controlled manner, as opposed to turning all rails off immediately. The SequenceOffOnFault bit in the MFR_CONFIG_LTC2977 register sets this behavior on each channel. The DC2023A demo board has been configured to sequence off all channels when a fault occurs. Pressing the “CREATE FAULT” pushbutton causes the FAULT pin to be asserted low which triggers all rails to power down based on the TOFF_DELAY times.

General Configuration Registers	
MFR_CONFIG_LTC2977	(0x4080) Expand for Detail...
TrackingSlave	<input type="checkbox"/> False
SequenceOffOnFault	<input checked="" type="checkbox"/> True
RESERVED13	<input type="checkbox"/> 0x0
RESERVED12	<input type="checkbox"/> 0x0
fast_servo_off	<input type="checkbox"/> 0x0 (fast-servo enabled)
supervisor_resolution	<input type="checkbox"/> 0x0 (Supervisor is HI-RES)
adc_hires	<input type="checkbox"/> 0x0 (ADC is LO-RES)
controln_sel	<input type="checkbox"/> 0x0 (Control0 is Selected)
servo_continuous	<input checked="" type="checkbox"/> 0x1 (Continuously servo VOUT t...
servo_on_warn	<input type="checkbox"/> 0x0 (Do NOT allow the unit to re-...
dac_mode	<input checked="" type="checkbox"/> 0x0 (DAC Soft Connect)

Figure 4 shows FAULTB asserting low, and each of the channels sequencing off per the TOFF_DELAY settings. Figure 5 shows the same except that the 3.0V rail (CH12) does not have its SequenceOffOnFault bit set. The 3.0V rail powers down immediately as defined by the fault response setting.

Clearing a Fault

To clear a fault, the user may click the CF icon in the GUI or simply push the RESET pushbutton on the demo board. In both cases, the red (+) on the CF icon and alert LED on the board will be cleared. You will notice that all rails are automatically re-enabled after a programmable retry period. The alert LED may be cleared by pushing the Clear Faults (CF) icon in the GUI. After clearing faults, the system tree may remain “yellow” if any non-volatile fault logs are present. For further information, see the Working with the Fault Log section.



Resetting The DC2023A

A reset pushbutton is provided on the board. To reset all devices on the DC2023A board and reload the EEPROM contents into operating memory (RAM), press RESET (SW1) on the DC2023A.

DC2023A LEDs

Each individual channel on DC2023A also has its own green “power good” LED (CH0 through CH15). When USB power (DC1613 Controller) or external power (6-14V jack) is applied, the +5V green LED will illuminate, indicating that the LTM2987 is powered. The red LEDs will illuminate when an alert or a fault has occurred.



Figure 4. Sequencing Off (SeqOffOnFault=1)

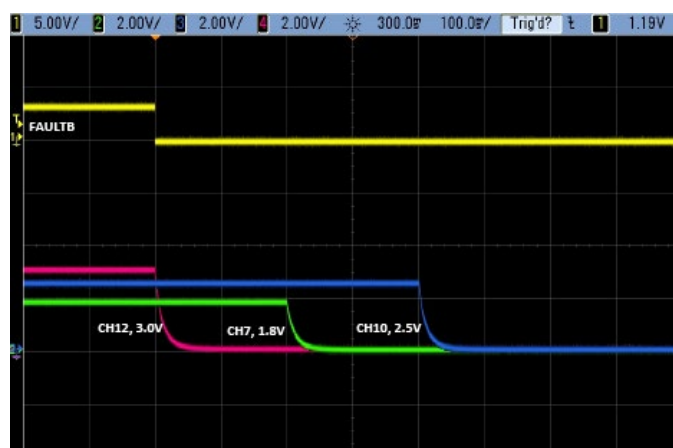

Figure 5. Sequencing Off (SeqOffOnFault=0)

COMMON DEMO BOARD OPERATIONS

Sequencing Output Channels

The LTM2987 has been pre-programmed to different TON_DELAY values for each channel. The TON_DELAY parameter is applied to each device relative to its respective CONTROL pin. When multiple demo boards are connected together, all CONTROL pins are wire OR'd. Therefore the TON delays are enforced relative to one edge. The same applies to TOFF_DELAY values. When the CONTROL switch is set to the OFF position, all rails will power down sequentially based on each of the device's TOFF_DELAY values. Figure 6 shows an oscilloscope screen capture of

three output rails sequencing up and down in response to the CONTROL pin.

Each channel has an LED which visually indicates if the channel has power. When the CONTROL pin is switched on and off, you will observe the relative on/off timing of the 16 channels.

For the LTM2987, the TON_DELAY and TOFF_DELAY values extend to 13.1 seconds, providing very long on and off sequencing of power supply rails.

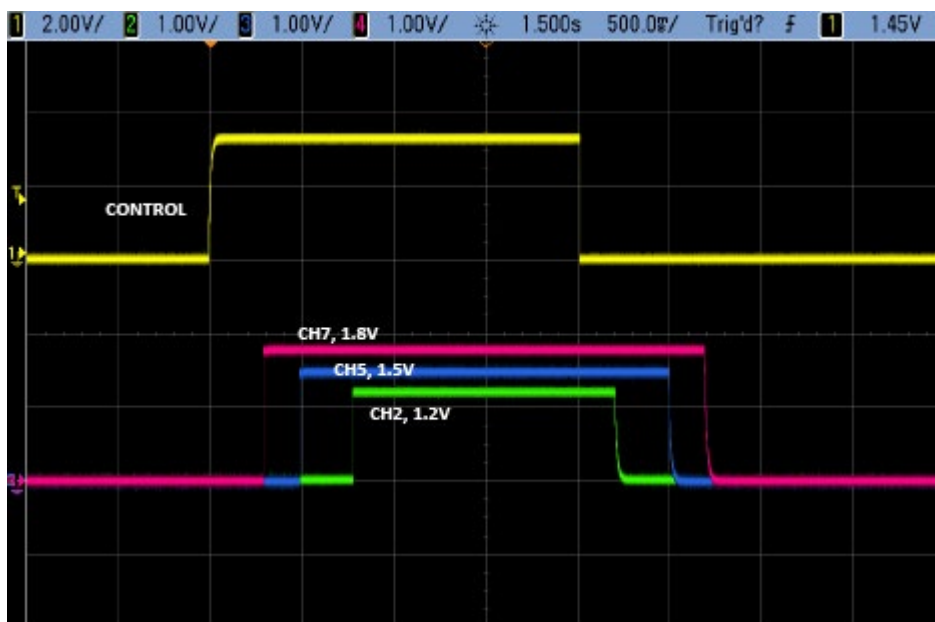

Figure 6. Sequencing Output Channels with DC2023A Using TON_DELAY and TOFF_DELAY

[16 rails] TON_DELAY	
TON_DELAY (All Pages in System)	
U0:0 - LTM2987	1000,000 ms
U0:1	900,000 ms
U0:2	800,000 ms
U0:3	700,000 ms
U0:4	600,000 ms
U0:5	500,000 ms
U0:6	400,000 ms
U0:7	300,000 ms
U1:0 - LTM2987	0,000 ms
U1:1	100,000 ms
U1:2	200,000 ms
U1:3	300,000 ms
U1:4	400,000 ms
U1:5	500,000 ms
U1:6	600,000 ms
U1:7	700,000 ms

Figure 7. TON_DELAY Configuration

[16 rails] TOFF_DELAY	
TOFF_DELAY (All Pages in System)	
U0:0 - LTM2987	0,000 ms
U0:1	100,000 ms
U0:2	200,000 ms
U0:3	300,000 ms
U0:4	400,000 ms
U0:5	500,000 ms
U0:6	600,000 ms
U0:7	700,000 ms
U1:0 - LTM2987	650,000 ms
U1:1	600,000 ms
U1:2	500,000 ms
U1:3	400,000 ms
U1:4	300,000 ms
U1:5	200,000 ms
U1:6	100,000 ms
U1:7	0,000 ms

Figure 8. TOFF_DELAY Configuration

COMMON DEMO BOARD OPERATIONS

Why Am I Off? Tool

Use the Why am I Off tool in the LTpowerPlay GUI to diagnose the reason a power supply channel is turned off.

The tool can be located in the top right corner of the GUI, next to the Register Information tab. Hover your cursor over this tab to show the tool.

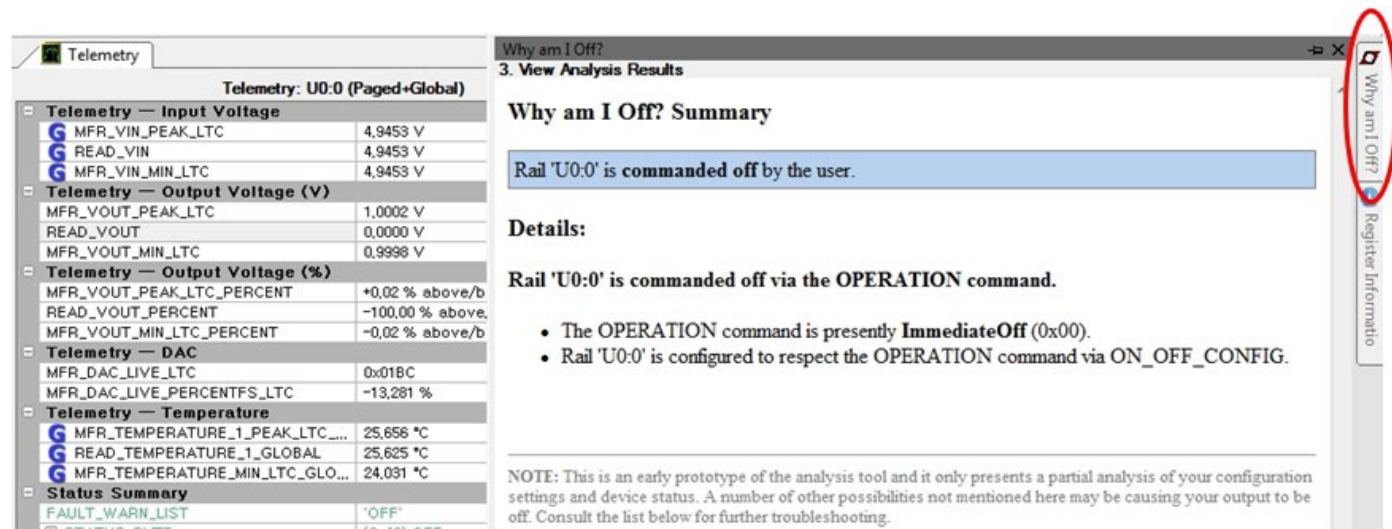

Figure 9. Why Am I Off Tool in the LTpowerPlay GUI

ADVANCED DEMO BOARD OPERATIONS

What Is a Fault Log?

A fault log is a non-volatile record of the power system leading up to the time of fault. It holds the most recent monitored values (up-time, voltage, current, temperature) that can be analyzed to help determine the cause of the fault. It is a powerful diagnostic feature of the LTM2987 on the DC2023A demo board.

Create a Fault and Fault Log

To create a fault log, you must create a fault, as described in the Creating a Fault section. If multiple boards are configured, select the appropriate device in the system tree by clicking on the appropriate LTM2987 chip. We will proceed to work with the fault log.

Working with the Fault Log

Once a fault has occurred, the Fault Log (FL) icon will show a red (+) sign on it, indicating that the GUI has detected a fault log in the device. Clicking the icon will bring up a dialog box. Note that it is context sensitive. Be sure that the desired device is selected in the system tree.



Notice that the checkbox “Log to EEPROM on Fault” is checked. Once a fault occurs, the device will automatically write the fault log data to EEPROM (NVM). At this point, the log is locked and will not change until it is cleared by

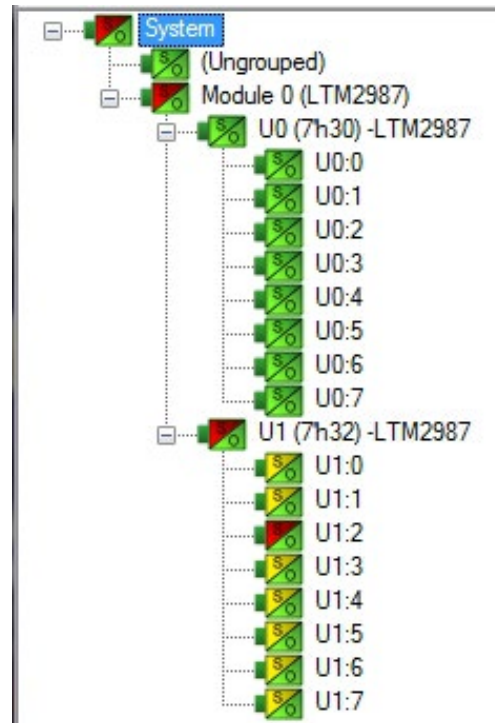

the user. To read the EEPROM log data, first click the “NVM to RAM” button. At this point the RAM Log is locked and not updated even though the telemetry readings continue. Click the “Read RAM Log” button. The log data will appear in the text box below.

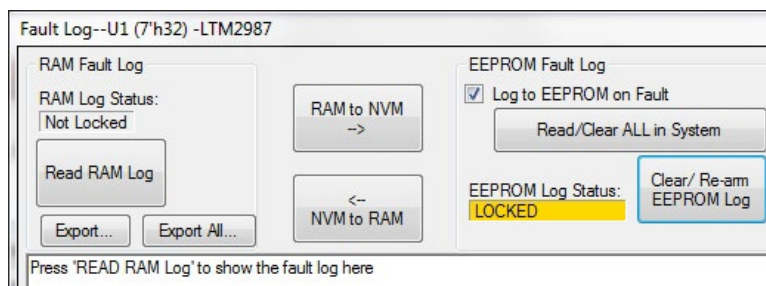

ADVANCED DEMO BOARD OPERATIONS

The log contains timestamp, up-time, channel voltage readings, an input voltage reading, an on-chip temperature reading, etc. There will be a number of loops; each loop contains data obtained in one ADC loop time with the most recent ADC loop data on top and the oldest data at the bottom of the log. The up-time indicates, at the time of fault, the amount of time the device has been powered up or time since the previous reset.

In this case, the fault log will show that channel U1:2 faulted due to a VOUT_UV_FAULT condition. On the previous telemetry loop, the channel voltage reading was a nominal value (2.5V).

To clear the fault log, click the “Clear/Rearm EEPROM Log” button. This allows the selected device to be ready for a new fault event. To clear all faults, click the Clear Faults (CF) icon.

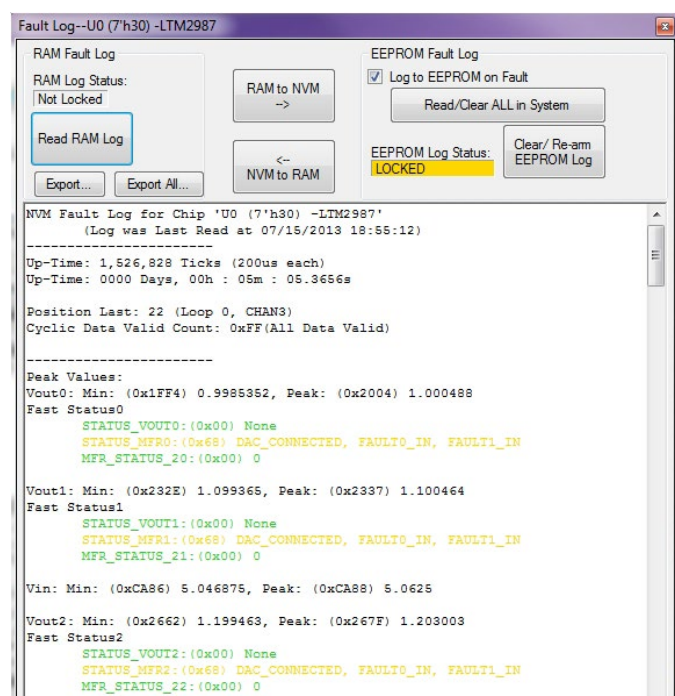

Fault Sharing Setup in the GUI

Fault sharing provides a means of propagating a fault detected by a power system manager to other power system managers via FAULT pins. Use the Fault Sharing Setup Tool to configure the fault sharing in the GUI. Select the LTM2987 labeled U0 in the system tree. Go to Utilities > Fault Sharing Diagram. For more details on this topic, please refer to the Fault Management section in the data sheet.

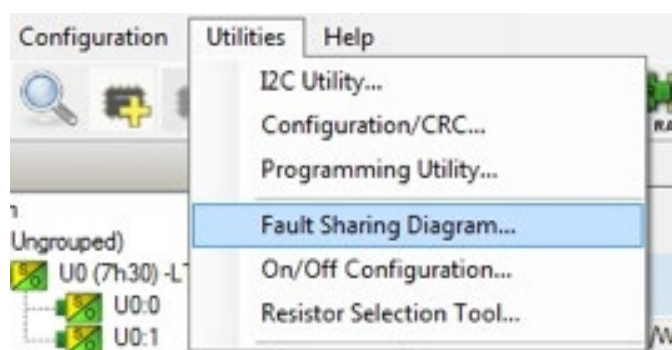

The fault sharing dialog will appear as shown in Figure 10. All Response and all Propagate switches are closed by default. In this configuration, a fault on one of the LTM2987 channels will shut down all 16 channels, and a fault on any LTM2987 channel will propagate to all channels on the DC2023A demo board since the fault pins are tied together.

Note: All FAULT pins on the LTM2987 are tied together on the DC2023A demo board. These pins are open drain and have a common pull-up resistor to provide a logic high level (inactive). All FAULT pins are active low.

There are two types of actions to fault conditions: How a channel responds to another channel’s fault and whether a particular channel propagates a fault to other channels. FAULT pins are bidirectional, meaning the device may drive its FAULT pin low (output) or may respond to the FAULT

ADVANCED DEMO BOARD OPERATIONS

pin when another device drives it low (input). Because all FAULT pins are wire OR'd on the DC2023A, this hardware configuration allows one to program each device's fault settings on a channel-by-channel basis. By default, the LTM2987 is configured to shut down all channels if other devices fault and to broadcast its own fault via the FAULT pins. A fault on these channels will cause only that channel to fault off. You can think of the "Response" switches as "shut this channel down when another channel faults", and the "Propagate" switches as "drive a fault pin to broadcast to other channels that this channel faulted".

Fault Configuration Example

Let's explore two different examples. Suppose we do not want channel U0:0 (CH0 1.0V rail) to propagate its fault to the other channels when it faults. And suppose we do not want channel U0:1 (CH1 1.1V rail) to shut down in response to another channel's fault. We can configure the switches as shown in Figure 11. Simply click the switches to open/close. Click OK to close the dialog box. Click the "PC->RAM" icon to write the changes to the DC2023A.

We can now create a fault on U0:0 (CH0) by shorting the output to ground. You may use a coin or a jumper to temporarily connect CH0 to the GND turret. You will notice that the channel shuts off but the other channels remain powered up because its fault is not propagated to the other channels. After the retry period, channel U0:0 (CH0) will power back up. We can now observe the effect of changing the response setting on U0:1 (CH1). If you short U0:2 (CH2 1.2V rail) to ground, notice that all rails shut down except U0:1 (CH1). This is an example of a keep-alive channel that remains powered up independent of faults on other channels.

Multiple DC2023A boards can be combined to control up to 128 independent power supplies. Eight boards may be cascaded. The number of boards is limited by an I/O expander chip that has three address pins, allowing eight different combinations. This setup demonstrates the coordinated fault responses and accurate time base shared across multiple LTM2987 modules.

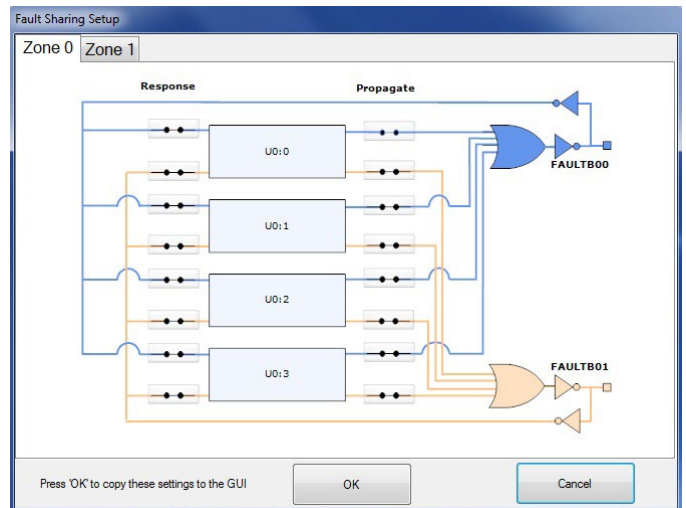

Figure 10. Fault Sharing Utility in LTpowerPlay GUI

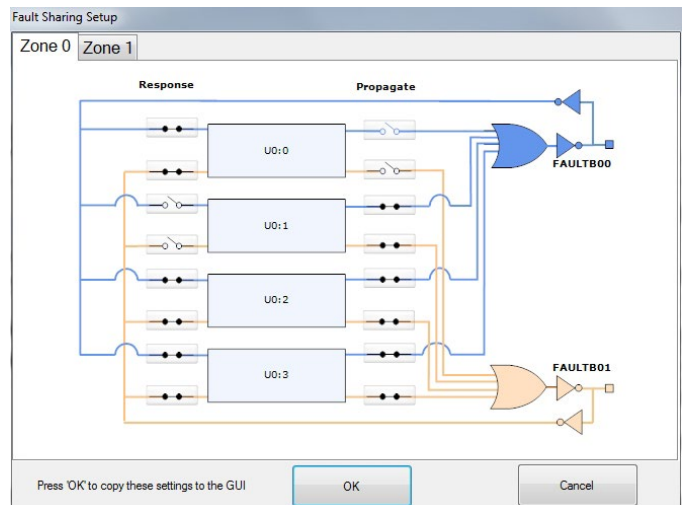

Figure 11. Updated Fault Sharing Configuration

SETUP PROCEDURE FOR MULTI-BOARD ARRAYS

Procedure:

1. Stack the boards side-by-side by plugging JP1 of one board into JP2 of another DC2023A board.
2. Ensure different slave address settings for each of the boards. The address of each board is set by the DIP switch JP3 on the backside of the board. The setting must be unique for each board in the array.
3. Plug in the +12V V_{IN} power into one of the boards as shown in Figure 12. Only one +12V power source is allowed.
4. The USB to I²C/SMBus/PMBus Controller may be plugged into any board. If no LTM2987s show up in the GUI, click the hourglass icon to enumerate the I²C bus and find the addresses of the parts. Go to step 2 to ensure that each board has a unique DIP switch setting.

5. Since the individual CONTROL lines are connected across the boards (CTRL is a common signal across all boards in the array), make sure that all CONTROL switches are set to the RUN position.
6. Relaunch LTpowerPlay. It will enumerate the entire board array and build a representative system tree and read all hardware settings into the GUI.

Attention: Once the GUI has launched, click the "RAM->NVM" button in the toolbar to ensure that the slave addresses are retained after a power off or reset. Otherwise you may lose communication with the slaves after a power cycle or reset event.



Figure 12. Array of Multiple DC2023A Demo Boards

SETUP PROCEDURE FOR MULTI-BOARD ARRAYS

Ensuring Slave Addresses Do Not Conflict

There is a small DIP switch on the backside of the DC2023A. It is used to set the slave address of an I/O expander which provides for the addition of multiple boards to a setup.

The I/O expander has a base address of 0x20. The DIP switch settings set the offset. The three switches that may be changed are labeled A0, A1, A2. Examples below set the boards to addresses 0x20 and 0x27.

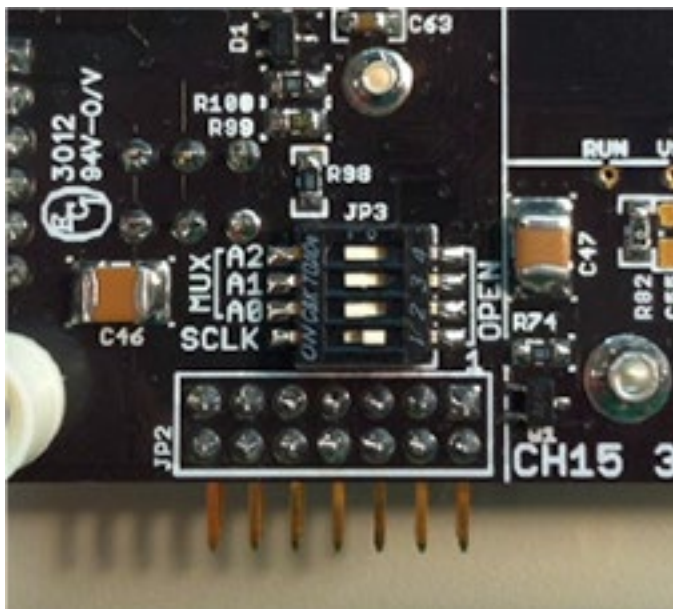

Figure 13. DIP Switch Set to All Zeros (0x20)

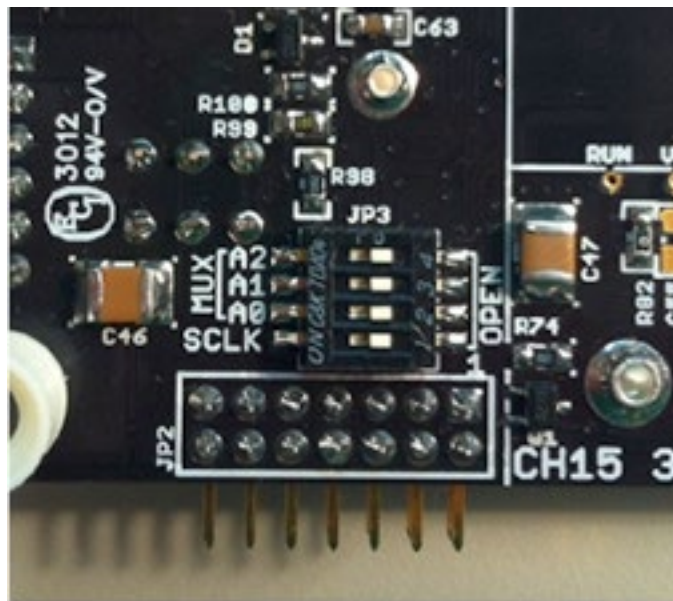

Figure 14. DIP Switch Set to All Ones (0x27)

DC2023 DETAILS—TOP

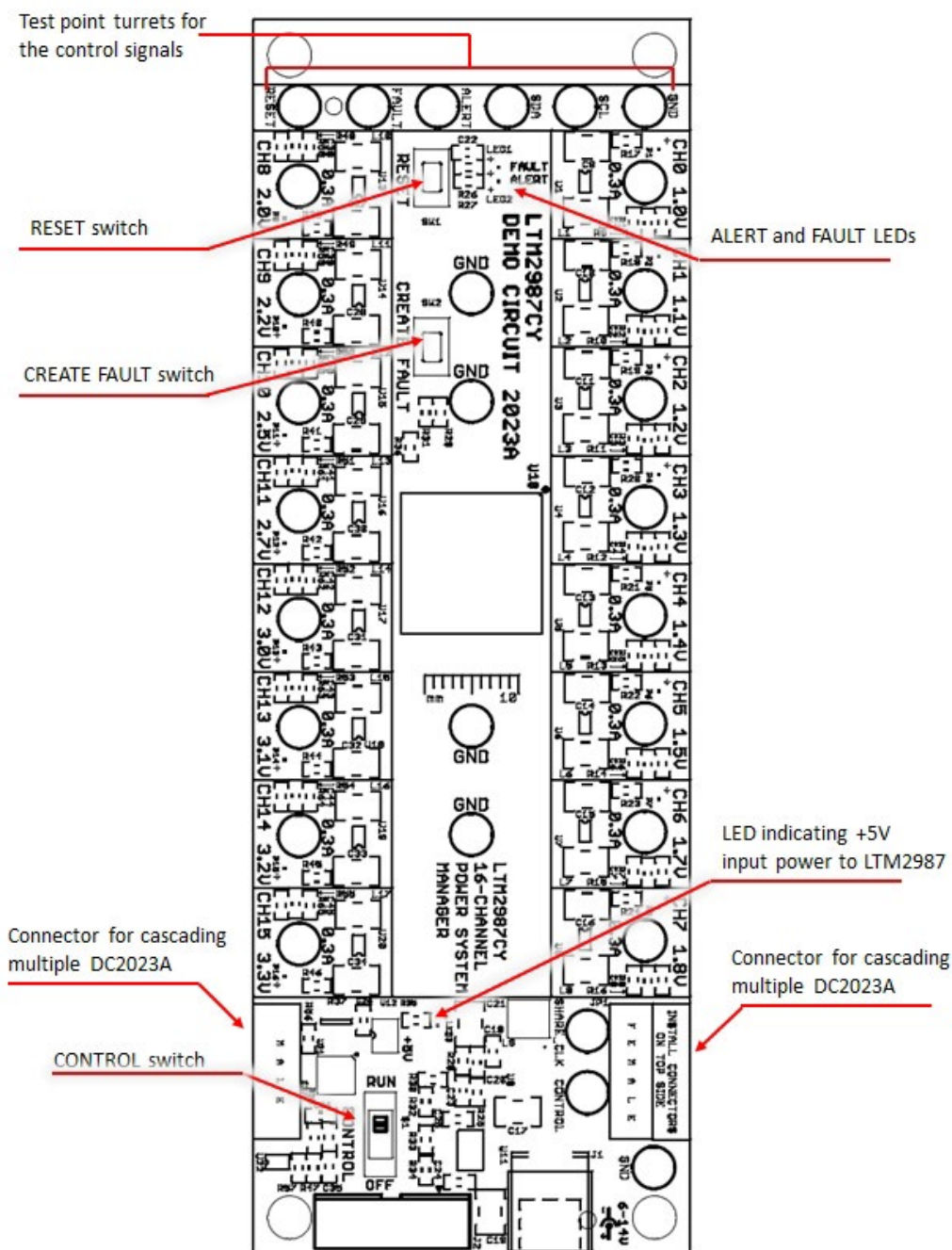
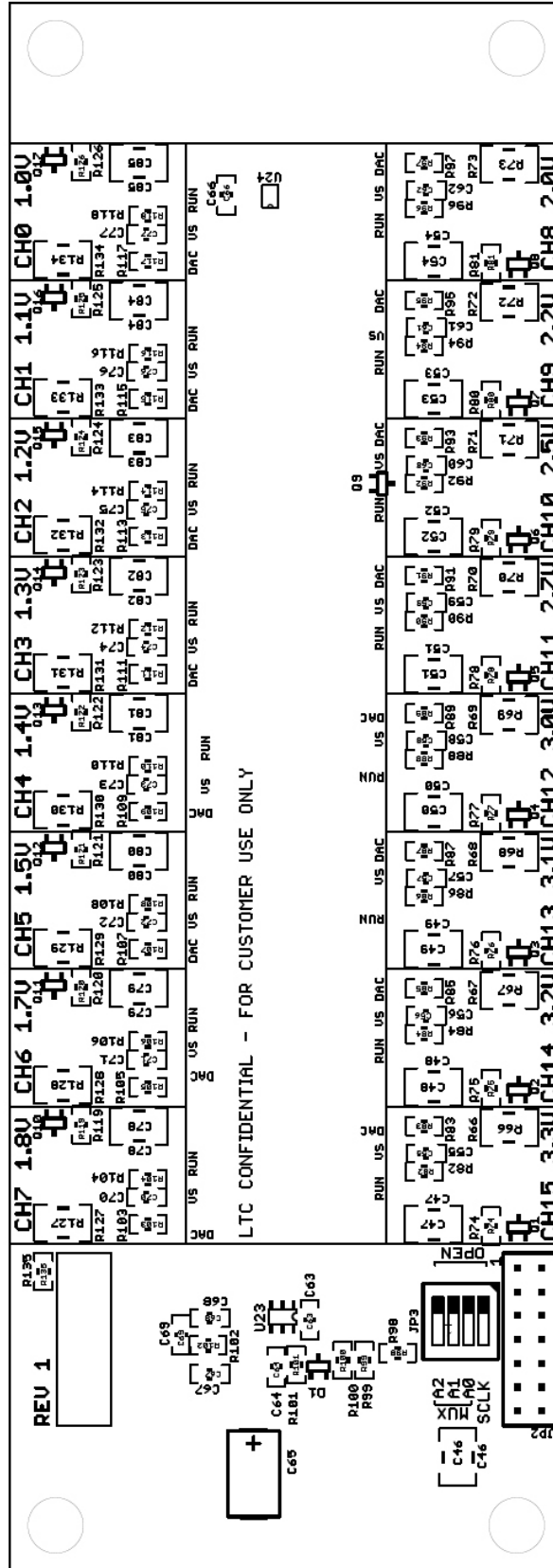

Table 1. DC2023A: Default Switch Configuration (Default Position Shown in Grey in the Figure Above)

REFERENCE DESIGNATOR	SIGNAL NAME	USAGE	DEFAULT
JP3	SCLK, A0, A1, 2	DIP Switch Used to Set the Address Offset of LTM2987	OPEN
S1	CONTROL	Switch Used to Enable/Disable the CONTROL Input Pins of LTM2987	RUN

DC2023 DETAILS—BOTTOM



PARTS LIST

ITEM	QTY	REFERENCE	PART DESCRIPTION	MANUFACTURER/PART NUMBER
Required Circuit Components				
1	1	U10	LTM2987 16-CH PWR SYSTEM MANAGER	LINEAR TECHNOLOGY: LTM2987CY
Additional Demo Board Circuit Components				
2	16	C1, C2, C3, C4, C5, C6, C7, C8, C38, C39, C40, C41, C42, C43, C44, C45	CAP CER 220pF 50V 10% NPO 0603	MURATA: GRM188R71H221KA01D
3	18	C9, C10, C11, C12, C13, C14, C15, C16, C19, C27, C28, C29, C30, C31, C32, C33, C34, C46	CAP CER 10µF 10V 10% X5R 1210	MURATA: GRM32ER61A106KC01L
4	1	C17	CAP CER 10µF 25V 20% X5R 1210	MURATA: GRM32DR61E106MA12L
5	2	C18, C26	CAP CER 0.1µF 16V 10% X7R 0603	MURATA: GRM188R71C104KA01D
6	2	C20, C69	CAP CER 68pF 50V 5% NPO 0603	MURATA: GRM1885C1H680JA01D
7	17	C21, C47, C48, C49, C50, C51, C52, C53, C54, C78, C79, C80, C81, C82, C83, C84, C85	CAP CER 22µF 10V 10% X5R 1210	MURATA: GRM32ER61A226KE20L
8	1	C22	CAP CER 10nF 25V 10% X7R 0603	MURATA: GRM188R71E103KA01D
9	1	C23	CAP CER 47pF 50V 5% NPO 0603	MURATA: GRM1885C1H470JA01D
10	7	C24, C25, C35, C36, C37, C63, C66	CAP CER 1µF 16V 10% X7R 0603	MURATA: GRM188R71C105KA12D
11	16	C55, C56, C57, C58, C59, C60, C61, C62, C70, C71, C72, C73, C74, C75, C76, C77 (OPT.)	CAP CER 0.1µF 16V 10% X7R 0603	MURATA: GRM188R71C104KA01D
12	2	C64, C67	CAP CER 4.7µF 16V 10% X5R 0603	TDK: C1608X5R1C475K
13	1	C65	CAP TANT 47µF 16V 20% 7343	AVX: TPSD476M016R0150
14	1	C68	CAP CER 4.7pF 50V NPO 0603	MURATA: GRM1885C1H4R7CZ01D
15	1	D1	DIODE SCHOTTKY 30V CC SOT-323-3	STMICROELECTRONICS: BAT30CWFILM
16	16	L1, L2, L3, L4, L5, L6, L7, L8, L10, L11, L12, L13, L14, L15, L16, L17	INDUCTOR SHLD POWER 4.7µH SMD	ABRACON: ASPI-0315FS-4R7M-T2 WURTH: 744029004 (ALTERNATE)
17	1	L9	INDUCTOR POWER 2.2µH 2.85A SMD	VISHAY: IHLP1616BZER2R2M01
18	17	LED3, P1, P2, P3, P4, P5, P6, P7, P8, P9, P10, P11, P12, P13, P14, P15, P16	LED GREEN SS TYPE BRIGHT SMD	PANASONIC - SSG: LNJ326W83RA
19	2	LED1, LED2	LED RED HI BRT SS TYPE LO CUR SM	PANASONIC - SSG: LNJ208R8ARA
20	17	Q1, Q2, Q3, Q4, Q5, Q6, Q7, Q8, Q9, Q10, Q11, Q12, Q13, Q14, Q15, Q16, Q17	MOSFET N-CH 30V 900MA SOT323-3	DIODE INC: DMG1012UW-7 VISHAY/SILICONIX: SI1304BDL-T1-E3 (ALTERNATE)
21	33	R1, R2, R3, R4, R5, R6, R7, R8, R29, R58, R59, R60, R61, R62, R63, R64, R65, R74, R75, R76, R77, R78, R79, R80, R81, R119, R120, R121, R122, R123, R124, R125, R126	RES 100k 1/10W 1% 0603 SMD	YAGEO: RC0603FR-07100KL
22	2	R9, R107	RES 402k 1/10W 1% 0603 SMD	YAGEO: RC0603FR-07402KL
23	1	R10	RES 267k 1/10W 1% 0603 SMD	YAGEO: RC0603FR-07267KL
24	1	R11	RES 200k1/10W 5% 0603 SMD	YAGEO: RC0603FR-07200KL
25	1	R12	RES 158k 1/10W 1% 0603 SMD	YAGEO: RC0603FR-07158KL
26	1	R13	RES 133k 1/10W 1% 0603 SMD	YAGEO: RC0603FR-07133KL
27	1	R14	RES 115k 1/10W 1% 0603 SMD	YAGEO: RC0603FR-07115KL
28	1	R15	RES 88.7k 1/10W 1% 0603 SMD	YAGEO: RC0603FR-0788K7L

DEMO MANUAL DC2023A

PARTS LIST

ITEM	QTY	REFERENCE	PART DESCRIPTION	MANUFACTURER/PART NUMBER
29	1	R16	RES 80.6k 1/10W 1% 0603 SMD	YAGEO: RC0603FR-0780K6L
30	17	R17, R18, R19, R20, R21, R22, R23, R24, R35, R39, R40, R41, R42, R43, R44, R45, R46	RES 3.01k 1/10W 1% 0603 SMD	YAGEO: RC0603FR-073K01L
31	10	R25, R32, R36, R47, R56, R57, R98, R99, R100, R135	RES 10.0k 1/10W 1% 0603 SMD	YAGEO: RC0603FR-0710KL
32	2	R26, R27	RES 698Ω 1/10W 1% 0603 SMD	YAGEO: RC0603FR-07698RL
33	2	R28, R102	RES 73.2k 1/10W 1% 0603 SMD	YAGEO: RC0603FR-0773K2L
34	1	R30	RES 46.4k 1/10W 1% 0603 SMD	YAGEO: RC0603FR-0746K4L
35	1	R31 (OPT)	RES 10.0k 1/10W 1% 0603 SMD	YAGEO: RC0603FR-0710KL
36	2	R33, R38	RES 249 OHM 1/10W 1% 0603 SMD	YAGEO: RC0603FR-07249RL
37	1	R34	RES 1.00k 1/10W 1% 0603 SMD	YAGEO: RC0603FR-071KL
38	1	R37	RES ARRAY 10k 4 RES 1206	VISHAY/DALE: CRA06S08310K0JTA
39	1	R48	RES 66.5k 1/10W 1% 0603 SMD	YAGEO: RC0603FR-0766K5L
40	1	R49	RES 57.6k 1/10W 1% 0603 SMD	YAGEO: RC0603FR-0757K6L
41	1	R50	RES 47.5K OHM 1/10W 1% 0603 SMD	YAGEO: RC0603FR-0747K5L
42	1	R51	RES 42.2k 1/10W 1% 0603 SMD	YAGEO: RC0603FR-0742K2L
43	1	R52	RES 36.5k 1/10W 1% 0603 SMD	YAGEO: RC0603FR-0736K5L
44	1	R53	RES 34.8k 1/10W 1% 0603 SMD	YAGEO: RC0603FR-0734K8L
45	1	R54	RES 33.2K OHM 1/10W 1% 0603 SMD	YAGEO: RC0603FR-0733K2L
46	1	R55	RES 32.4k 1/10W 1% 0603 SMD	YAGEO: RC0603FR-0732K4L
47	16	R66, R67, R68, R69, R70, R71, R72, R73, R127, R128, R129, R130, R131, R132, R133, R134	RES 470Ω 1/4W 5% 1210 SMD	VISHAY: CRCW1210470RJNEA
48	16	R82, R84, R86, R88, R90, R92, R94, R96, R104, R106, R108, R110, R112, R114, R116, R118	RES 0.0Ω 1/10W 0603 SMD	YAGEO: RC0603JR-070RL
49	1	R83	RES 182k 1/10W 1% 0603 SMD	YAGEO: RC0603FR-07182KL
50	1	R85	RES 191k 1/10W 1% 0603 SMD	YAGEO: RC0603FR-07191KL
51	1	R87	RES 196k 1/10W 1% 0603 SMD	YAGEO: RC0603FR-07196KL
52	1	R89	RES 205k 1/10W 1% 0603 SMD	YAGEO: RC0603FR-07205KL
53	1	R91	RES 226k 1/10W 1% 0603 SMD	YAGEO: RC0603FR-07226KL
54	1	R93	RES 243k 1/10W 1% 0603 SMD	YAGEO: RC0603FR-07243KL
55	1	R95	RES 274k 1/10W 1% 0603 SMD	YAGEO: RC0603FR-07274KL
56	1	R97	RES 301k 1/10W 1% 0603 SMD	YAGEO: RC0603FR-07301KL
57	1	R101	RES 2.49k 1/10W 1% 0603 SMD	YAGEO: RC0603FR-072K49L
58	1	R103	RES 340k 1/10W 1% 0603 SMD	YAGEO: RC0603FR-07340KL
59	1	R105	RES 357k 1/10W 1% 0603 SMD	YAGEO: RC0603FR-07357KL
60	1	R109	RES 374k 1/10W 1% 0603 SMD	YAGEO: RC0603FR-07374KL
61	1	R111	RES 464k 1/10W 1% 0603 SMD	YAGEO: RC0603FR-07464KL
62	1	R113	RES 511k 1/10W 1% 0603 SMD	YAGEO: RC0603FR-07511KL
63	1	R115	RES 549K OHM 1/10W 1% 0603 SMD	YAGEO: RC0603FR-07549KL
64	1	R117	RES 604k 1/10W 1% 0603 SMD	YAGEO: RC0603FR-07604KL

PARTS LIST

ITEM	QTY	REFERENCE	PART DESCRIPTION	MANUFACTURER/PART NUMBER
65	16	U1, U2, U3, U4, U5, U6, U7, U8, U13, U14, U15, U16, U17, U18, U19, U20	IC BUCK SYNC ADJ 0.3A SOT23-6	LINEAR TECHNOLOGY: LTC3405AES6#TRMPBF
66	1	U9	IC BUCK SYNC 2.5A 16QFN	LINEAR TECHNOLOGY: LTC3604IUD#PBF
67	1	U12	IC 2WIRE BUS BUFFER 8MSOP	LINEAR TECHNOLOGY: LTC4313CMS8-2#PBF
68	1	U11	IC DUAL 4A DIODES 16-MSOP	LINEAR TECHNOLOGY: LTC4415IMSE#PBF
69	1	U23	IC VREF SERIES PREC TSOT-23-6	LINEAR TECHNOLOGY: LT6654BMPS6-1.25#TRMPBF
70	1	U21	IC I/O EXPANDER I2C 8B 20QFN	MICROCHIP: MCP23008-E/ML
71	1	U22	IC EEPROM 2KBIT 400KHZ SOT23-5	MICROCHIP TECHNOLOGY: 24AA02T-I/OT
72	1	U24	IC BUFFER DUAL NON-INV SC706	TI: SN74LVC2G34DCKR

Hardware – For Demo Board Only

73	1	J1	CONN PWR JACK 2.1X5.5MM HIGH CUR	CUI INC: PJ-002AH
74	1	J2	CONN HEADER 12POS 2MM STR DL PCB	FCI: 98414-G06-12ULF
75	1	JP1	CONN RECEPT 2MM DUAL R/A 14POS	SULLINS CONNECTOR SOLUTIONS:NPPN072FJFN-RC
76	1	JP2	CONN HEADER 14POS 2MM R/A GOLD	MOLEX CONNECTOR CORPORATION: 87760-1416
77	1	JP3	SWITCH DIP 4POS HALF PITCH SMD	C&K COMPONENTS: TDA04H0SB1
78	4	MH1, MH2, MH3, MH4	SPACER STACKING #4 SCREW NYLON	KEYSTONE: 8831
79	1	S1	SW SLIDE DPDT 6VDC 0.3A PCMNT	C&K COMPONENTS: JS202011CQN
80	1	SW1	SWITCH TACTILE SPST-NO 0.05A 12V BLK	C&K COMPONENTS: PTS635SL25SMTR LFS
81	1	SW2	SWITCH TACTILE SPST-NO 0.05A 12V RED	C&K COMPONENTS: PTS635SK25SMTR LFS
82	29	TP1, TP2, TP3, TP4, TP5, TP6, TP7, TP8, TP9, TP10, TP11, TP12, TP13, TP14, TP15, TP16, TP17, TP18, TP19, TP21, TP22, TP23, TP24, TP25, TP26, TP27, TP28, TP29, TP30	TERM SOLDER TURRET 0.219" 0.078"L	MILL-MAX: 2501-2-00-80-00-00-07-0
83	1	TP20	TERMINAL PIN TURRET 0.109" SOLDER	MILL-MAX: 2308-2-00-80-00-00-07-0

SCHEMATIC DIAGRAM

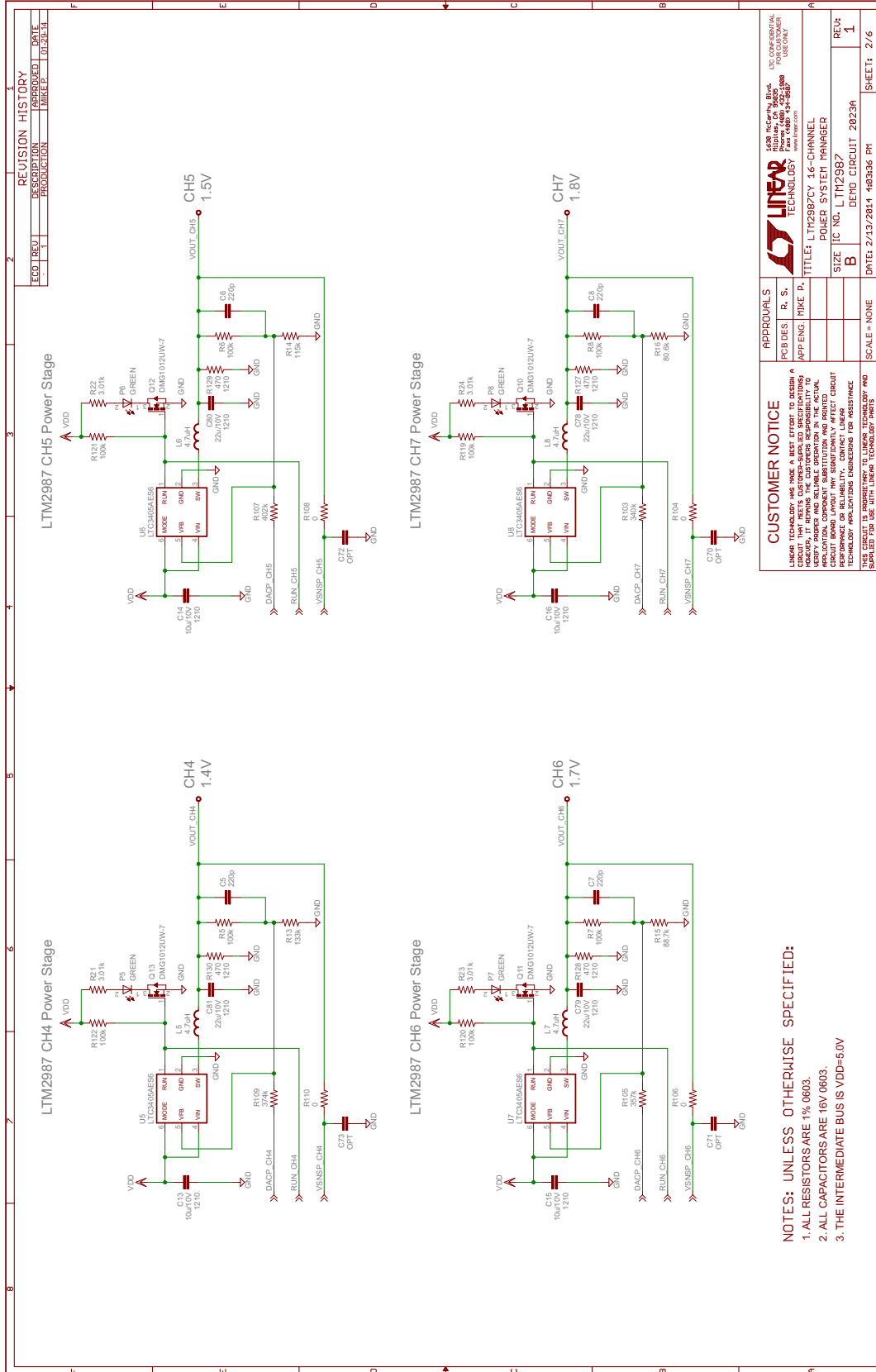

REVISION HISTORY

REV	DESCRIPTION	DATE
1.0	PRODUCTION	01/20/14

CUSTOMER NOTICE

LINEAR TECHNOLOGY HAS MADE A BEST EFFORT TO DESIGN A BOARD THAT MEETS THE CUSTOMER'S REQUIREMENTS. HOWEVER, IT REMAINS THE CUSTOMER'S RESPONSIBILITY TO VERIFY THAT THE BOARD DESIGN MEETS ALL APPLICABLE REGULATORY, CAPABILITY, SUBSTITUTION AND PRODUCTION REQUIREMENTS. LINEAR TECHNOLOGY ACCEPTS NO LIABILITY FOR ANY SIMULTANEOUSLY EFFECTIVE CIRCUIT BOARD DESIGN OR ANY OTHER BOARD DESIGN. THIS CIRCUIT IS PROPRIETARY TO LINEAR TECHNOLOGY AND IS NOT TO BE REPRODUCED OR TRANSMITTED IN ANY FORM OR BY ANY MEANS, ELECTRONIC OR MECHANICAL, INCLUDING PHOTOCOPYING, RECORDING, OR BY ANY INFORMATION STORAGE AND RETRIEVAL SYSTEM.

APPROVALS

DESIGNER	DATE	SCALE
APP/ENG: MIKE P.		NONE

DATE: 2/13/2014 140326.DPT

SCALE: NONE

REVISIONS

REV	DESCRIPTION	DATE
1	POWER SYSTEM MANAGER	

TITLE: LTM2987CY 16-CHANNEL POWER SYSTEM MANAGER

SIZE: IC NO. LTM2987

REV: 1

SHEET: 2/6

- NOTES: UNLESS OTHERWISE SPECIFIED:
1. ALL RESISTORS ARE 1% 0603.
 2. ALL CAPACITORS ARE 16V 0603.
 3. THE INTERMEDIATE BUS IS VDD=5.0V

DEMO MANUAL DC2023A

SCHEMATIC DIAGRAM

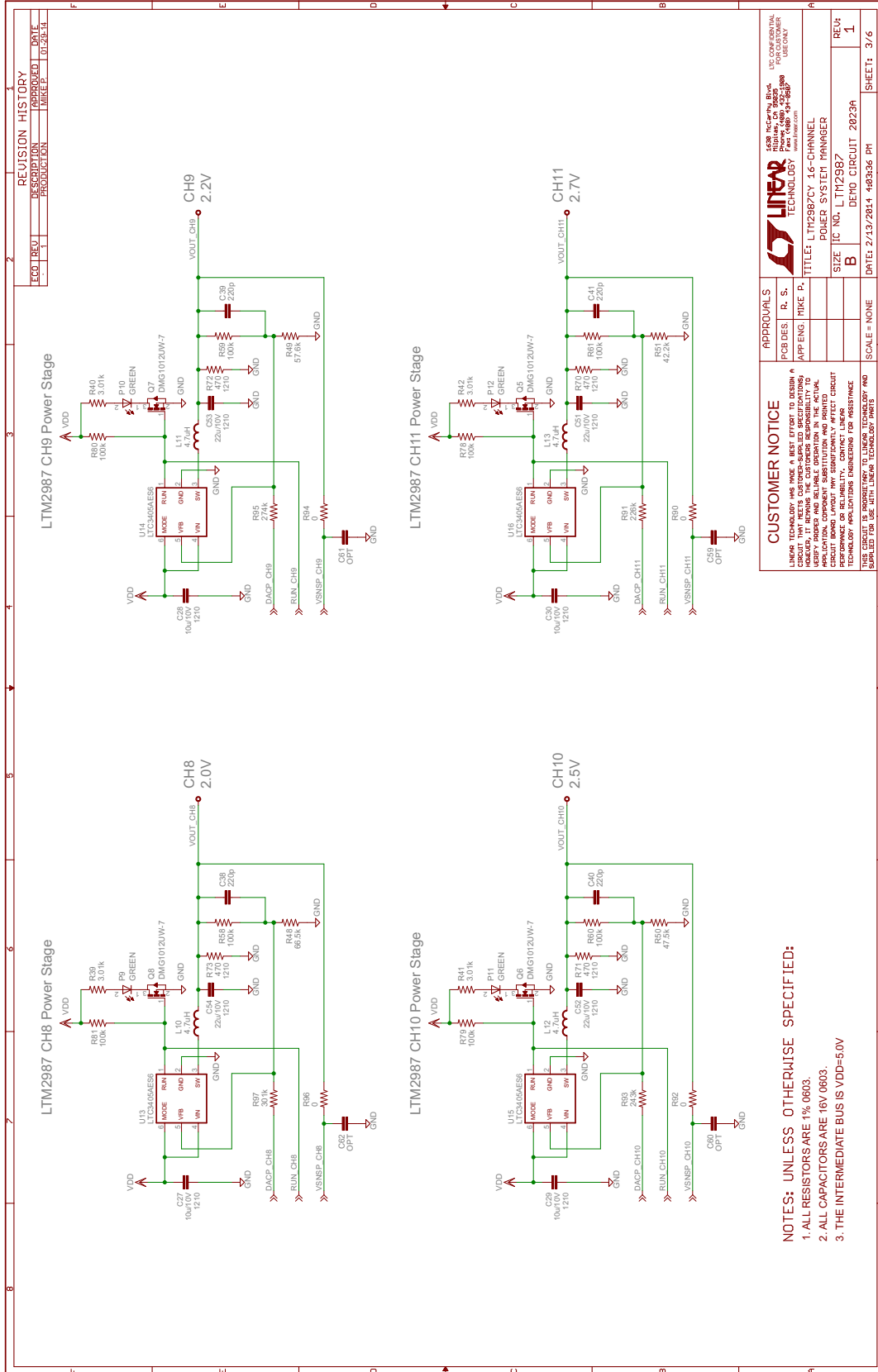

SCHEMATIC DIAGRAM

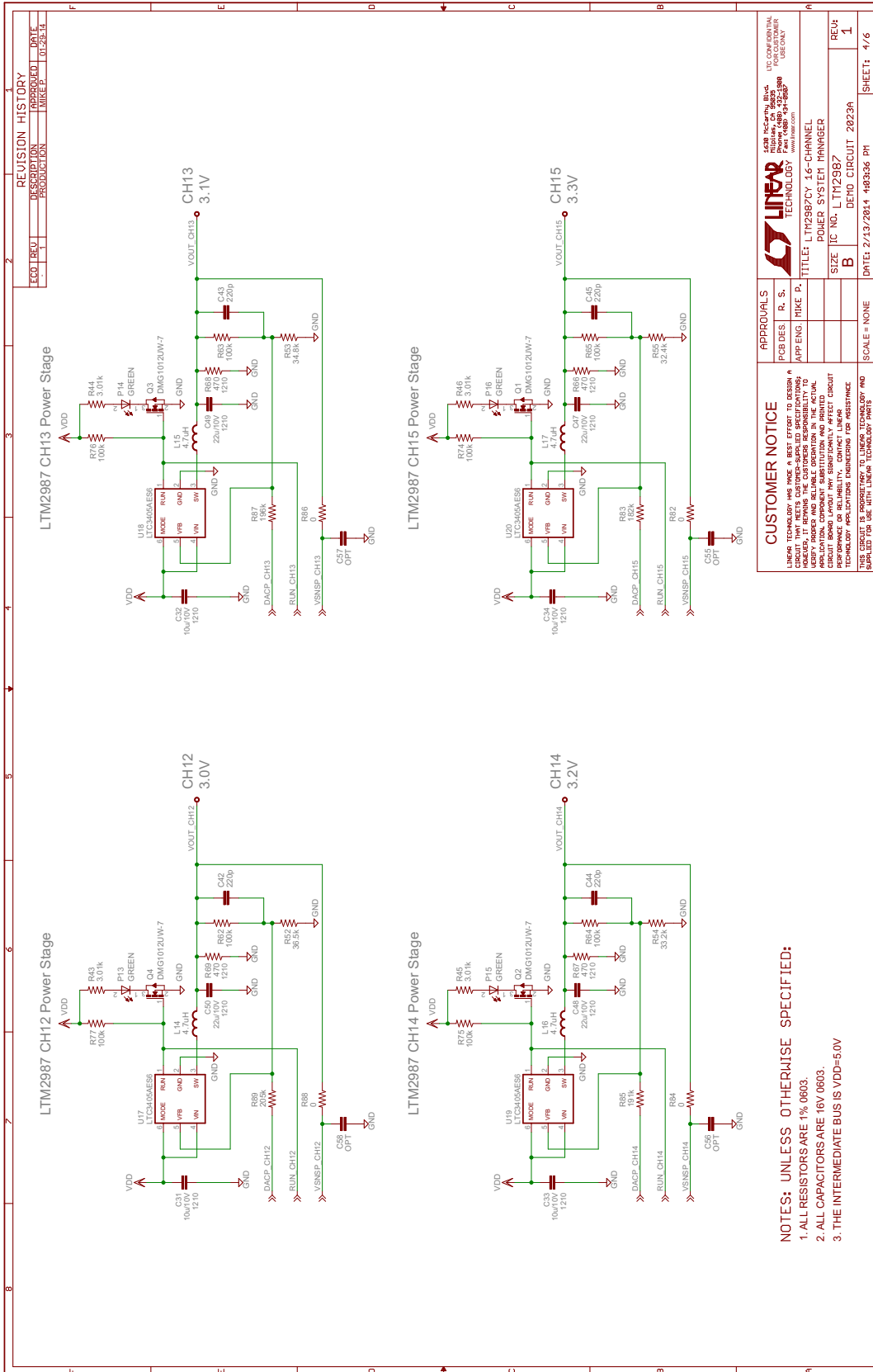

REVISION HISTORY

REV	DESCRIPTION	DATE
1	PRODUCTION	01/28/14
2	MIKE P.	

CUSTOMER NOTICE

LINEAR TECHNOLOGY HAS MADE A BEST EFFORT TO DESIGN A BOARD, IT REMAINS THE CUSTOMER'S RESPONSIBILITY TO VERIFY THAT THE BOARD MEETS ALL REQUIREMENTS FOR THE APPLICATION. CAPACITOR SUBSTITUTION AND BOARD CIRCUIT BOARD LAYOUT MAY SIGNIFICANTLY AFFECT CIRCUIT PERFORMANCE. LINEAR TECHNOLOGY PROVIDES ASSISTANCE TECHNOLOGY APPLICATIONS ENGINEERING FOR ASSISTANCE SUPPLIED FOR USE WITH LINEAR TECHNOLOGY PARTS

APPROVALS

PCB DES	R. S.
APP ENG	MIKE P.

TITLE: LTM2987CY 16-CHANNEL POWER SYSTEM MANAGER

SIZE: IC NO. LTM2987

SCALE: NONE

DATE: 2/13/2014 4:03:36 PM

SHEET: 4/6

- NOTES: UNLESS OTHERWISE SPECIFIED:
1. ALL RESISTORS ARE 1% 0803.
 2. ALL CAPACITORS ARE 16V 0603.
 3. THE INTERMEDIATE BUS IS VDD=5.0V

DEMO MANUAL DC2023A

SCHEMATIC DIAGRAM

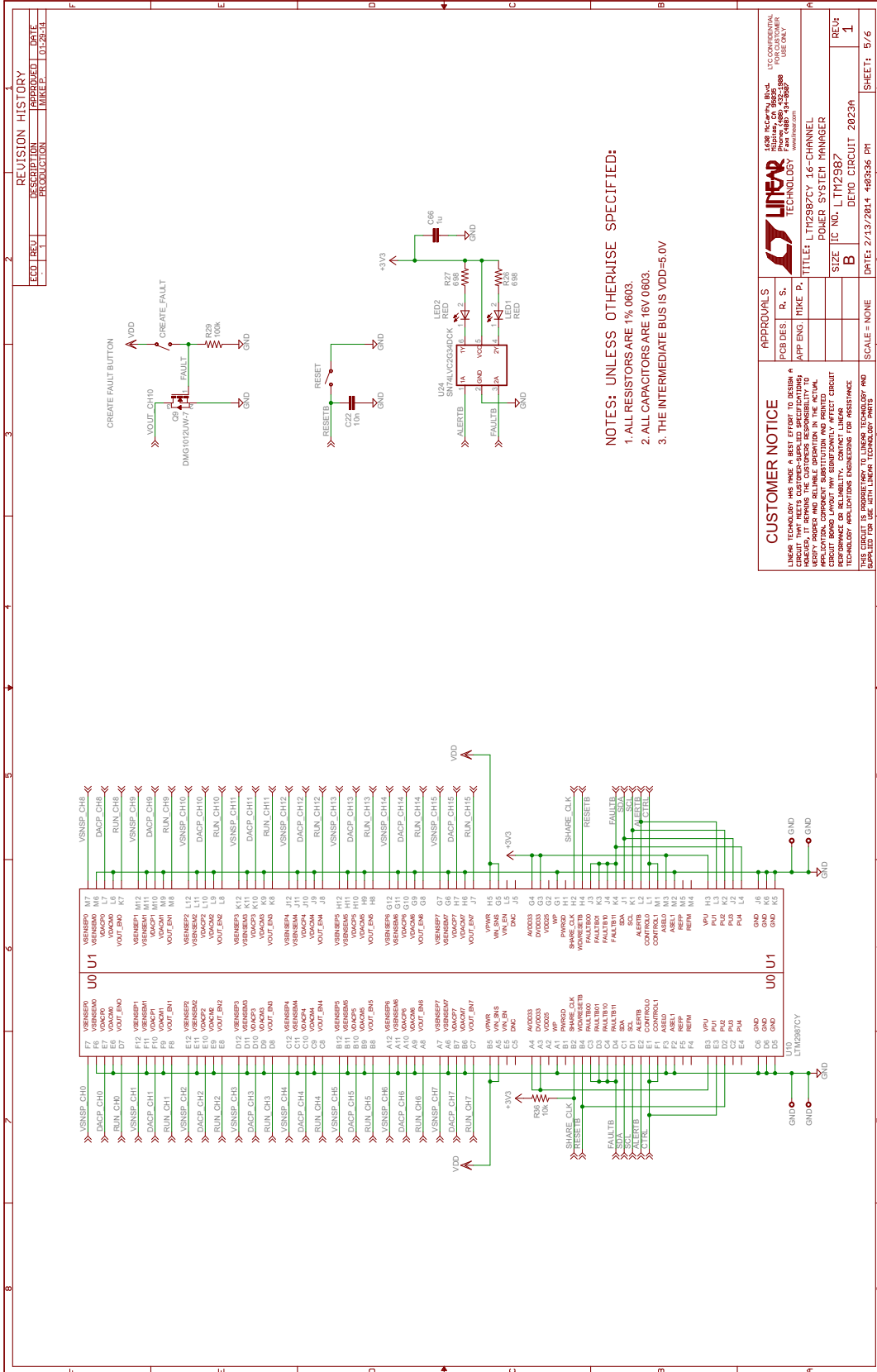

SCHEMATIC DIAGRAM

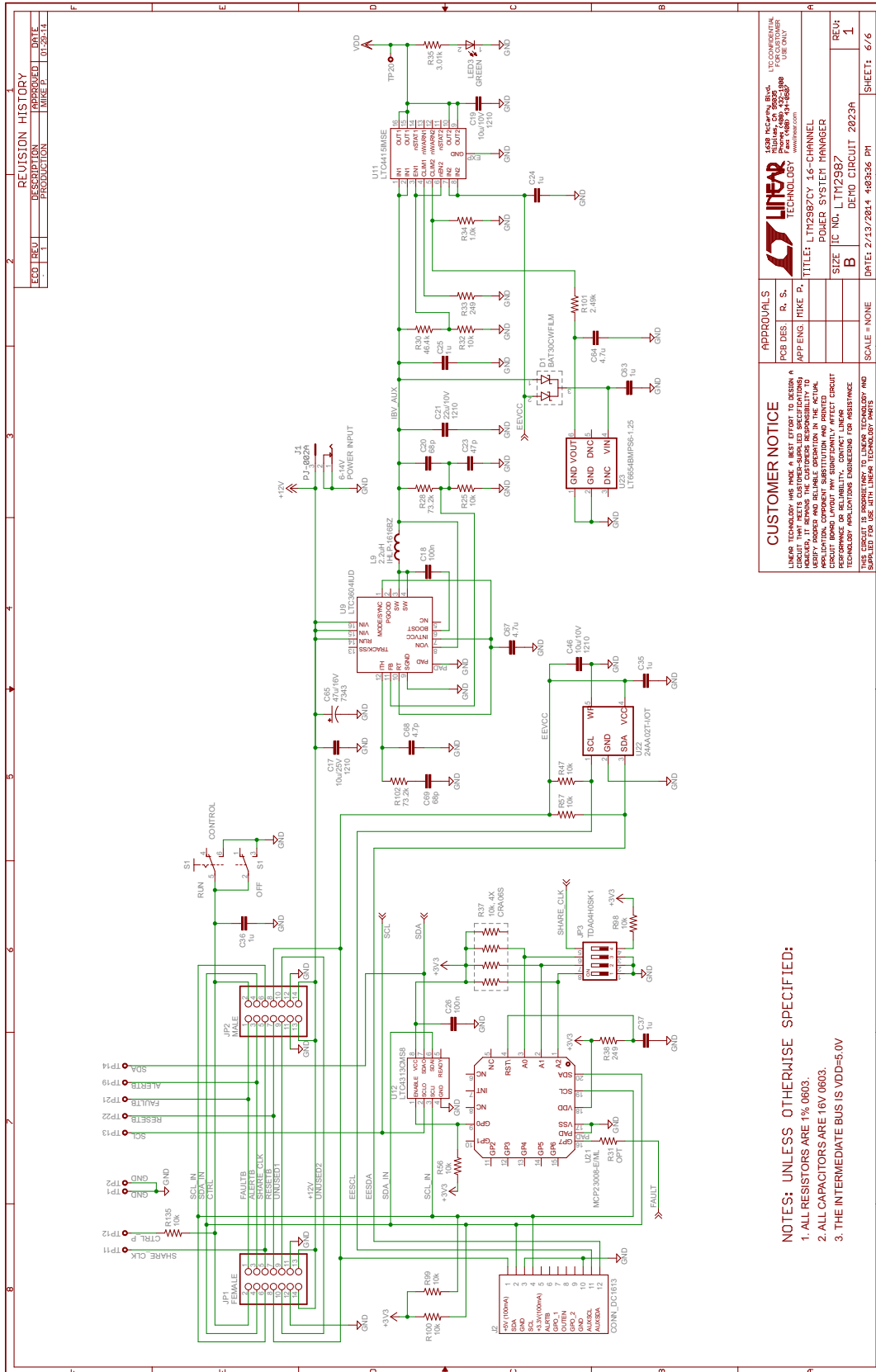

REVISION HISTORY	
1	1
2	1
3	1
4	1
5	1
6	1
7	1
8	1

CUSTOMER NOTICE	
<p>LINEAR TECHNOLOGY CORPORATION AND ITS AFFILIATED COMPANIES (LINEAR) ARE PROVIDING THIS SCHEMATIC AS A SERVICE TO OUR CUSTOMERS. LINEAR DOES NOT WARRANT THE ACCURACY OF THIS SCHEMATIC. CUSTOMERS ARE RESPONSIBLE FOR VERIFYING THE CORRECTNESS OF THIS SCHEMATIC FOR THEIR APPLICATION. CUSTOMERS SHOULD CONSULT WITH LINEAR BEFORE MAKING ANY CHANGES TO THIS SCHEMATIC. LINEAR IS NOT RESPONSIBLE FOR ANY DAMAGE TO PERSONS OR PROPERTY ARISING FROM THE USE OF THIS SCHEMATIC.</p>	
<p>THIS CIRCUIT IS PROPRIETARY TO LINEAR TECHNOLOGY AND IS SUPPLIED FOR USE WITH LINEAR TECHNOLOGY PARTS</p>	

APPROVALS	
FCB DES:	R. S.
APPENS:	MIKE P.

TITLE: LTM2987CY 1.6-CHANNEL POWER SYSTEM MANAGER	
SIZE:	IC NO. LTM2987
REV:	1
DATE:	2/13/2014 149336.PLT
SHEET:	6/6

- NOTES: UNLESS OTHERWISE SPECIFIED:
1. ALL RESISTORS ARE 1% 0603.
 2. ALL CAPACITORS ARE 16V/0603.
 3. THE INTERMEDIATE BUS IS VDD=5.0V

DEMO MANUAL DC2023A

DEMONSTRATION BOARD IMPORTANT NOTICE

Linear Technology Corporation (LTC) provides the enclosed product(s) under the following **AS IS** conditions:

This demonstration board (DEMO BOARD) kit being sold or provided by Linear Technology is intended for use for **ENGINEERING DEVELOPMENT OR EVALUATION PURPOSES ONLY** and is not provided by LTC for commercial use. As such, the DEMO BOARD herein may not be complete in terms of required design-, marketing-, and/or manufacturing-related protective considerations, including but not limited to product safety measures typically found in finished commercial goods. As a prototype, this product does not fall within the scope of the European Union directive on electromagnetic compatibility and therefore may or may not meet the technical requirements of the directive, or other regulations.

If this evaluation kit does not meet the specifications recited in the DEMO BOARD manual the kit may be returned within 30 days from the date of delivery for a full refund. **THE FOREGOING WARRANTY IS THE EXCLUSIVE WARRANTY MADE BY THE SELLER TO BUYER AND IS IN LIEU OF ALL OTHER WARRANTIES, EXPRESSED, IMPLIED, OR STATUTORY, INCLUDING ANY WARRANTY OF MERCHANTABILITY OR FITNESS FOR ANY PARTICULAR PURPOSE. EXCEPT TO THE EXTENT OF THIS INDEMNITY, NEITHER PARTY SHALL BE LIABLE TO THE OTHER FOR ANY INDIRECT, SPECIAL, INCIDENTAL, OR CONSEQUENTIAL DAMAGES.**

The user assumes all responsibility and liability for proper and safe handling of the goods. Further, the user releases LTC from all claims arising from the handling or use of the goods. Due to the open construction of the product, it is the user's responsibility to take any and all appropriate precautions with regard to electrostatic discharge. Also be aware that the products herein may not be regulatory compliant or agency certified (FCC, UL, CE, etc.).

No License is granted under any patent right or other intellectual property whatsoever. **LTC assumes no liability for applications assistance, customer product design, software performance, or infringement of patents or any other intellectual property rights of any kind.**

LTC currently services a variety of customers for products around the world, and therefore this transaction **is not exclusive**.

Please read the DEMO BOARD manual prior to handling the product. Persons handling this product must have electronics training and observe good laboratory practice standards. **Common sense is encouraged.**

This notice contains important safety information about temperatures and voltages. For further safety concerns, please contact a LTC application engineer.

Mailing Address:

Linear Technology
1630 McCarthy Blvd.
Milpitas, CA 95035

Copyright © 2004, Linear Technology Corporation