

# RTBV Series

## 1-2 Pole Coded Rotary Switches



### Features/Benefits

- **Totally sealed**
- **Detent angles, 15 , 22.5 , 30 and 36**
- **Multi pole**
- **Coding functions**
- **Robust construction**

### Typical Applications

- **Telecommunications**
- **Military**
- **Instrumentation**
- **Heavy-duty industrial equipment**

### Electrical Data

SWITCHING MODE:  
 MAX. SWITCHING POWER:  
 MAX. SWITCHING CURRENT:  
 MIN. SWITCHING CURRENT:  
 MAX. CARRYING CURRENT:  
 MAX. VOLTAGE:  
 MIN. VOLTAGE:  
 BOUNCE:  
 CONTACT RESISTANCE after life:  
 DIALECTRIC STRENGTH between contacts or contacts and frame:  
 INSULATION RESISTANCE between contacts or contacts and frame:

### Silver

BBM\*  
 5VA  
 250 mA  
 10 mA  
 5A  
 25V  
 5V  
 <5ms  
 <100mΩ  
 500 V rms  
 >10<sup>9</sup>Ω

### Gold

BBM\*  
 0.2VA  
 20 mA  
 1 mA  
 1A  
 25V  
 1V  
 <5ms  
 <100mΩ  
 500 V rms  
 >10<sup>9</sup>Ω

### Environmental Data

OPERATING TEMPERATURE: -25°C to +70°C  
 STORAGE TEMPERATURE: -40°C to +85°C  
 TOTALLY SEALED: Immersion test acc. to MIL R22.097 F and NFC 20631/QF

\* BBM= Break Before Make (non-starting)

### Materials

HOUSING: PBT thermoplastic and PC thermoplastic  
 STATIONARY CONTACTS & TERMINALS: Nickel plated Brass with additional Gold or Silver plating, insert molded in PBT thermoplastic.  
 ROTOR: Printed circuit, gold or silver plated.  
 ACTUATOR: Steel  
 BUSHING: Brass  
 HARDWARE: Stop pin and spring: Stainless steel  
 All models are RoHS compliant and compatible.

### Mechanical Data

NUMBER OF BANKS: 1 to 10  
 OPERATING TORQUE: 5 Ncm±30% (with 1 module)  
 MECHANICAL STOP RESISTANCE: >70 Ncm  
 BUSHING MOUNTING TORQUE: 100 Ncm

**NOTE:** Specifications and materials listed above are for switches with standard options. For information on specific and custom switches, consult Customer Service Center.

### Build-A-Switch

To order, simply select desired option from each category and place in the appropriate box. Available options are shown and described on pages K-25 thru K-29. For additional options not shown in catalog, consult Customer Service Center.



**Designation**  
**RTBV**

**Indexing**  
**1** 15°/24 positions max.  
**2** 22.5°/16 positions max.  
**3** 30°/12 positions max.  
**4** 36°/10 positions max.

**Number of Banks\*\***  
**1** 1 Bank  
**2** 2 Banks  
**3** 3 Banks  
**4** 4 Banks

**Switch Function Number of Poles or code (binary code = B, complement = C, direct +complement = BC) (first digit), Stop (with=S, without=W), Maximum Position (third & fourth digit)**

**1S02** SP, 02 positions with stop  
**1S03** SP, 03 positions with stop  
**1S04** SP, 04 positions with stop  
**1S05** SP, 05 positions with stop  
**1S06** SP, 06 positions with stop  
**1S07** SP, 07 positions with stop  
**1S10** SP, 10 positions with stop  
**1W10** SP, 10 positions without stop  
**1S11** SP, 11 positions with stop  
**1S12** SP, 12 positions with stop  
**1W12** SP, 12 positions without stop

**1S14** SP, 14 positions with stop  
**1S16** SP, 16 positions with stop  
**1W16** SP, 16 positions without stop  
**1S24** SP, 24 positions with stop  
**1W24** SP, 24 positions without stop  
**2S04** DP, 4 positions with stop  
**2S05** DP, 5 positions with stop  
**2S06** DP, 6 positions with stop

### Seal

**A** Standard bushing for panel mount  
**D** Sealed bushing for panel mount

### Shaft Diameter & Style\*\*\*

**N** Metric shaft .236 (6,0)  
**P** Standard shaft .250 (6,35)  
**F** Metric shaft with flat .236 (6,0)  
**G** Standard shaft with flat .250 (6,35)  
**S** Metric shaft with slot .236 (6,0)  
**T** Standard shaft with slot .250 (6,35)

### Actuator Option Angle\*

**N** None for actuators without a flat  
**0** 0° angle  
**3** 30° angle  
**6** 60° angle  
**9** 90° angle  
**2** 120° angle  
**8** 180° angle  
**7** 270° angle

### Contact Material

**S** Silver plated, matte-tin terminal  
**P** Gold plated, matte-tin terminal

### Actuator Length

**Z** (.984) 25 mm

\* Other angles available by request

\*\* Several functions can be combined. For more information consult us.

\*\*\*Note: Metric diameter shafts are only available with metric diameter bushings, standard 1.250 inch diameter shafts are only available with standard 3/8 diameter bushings.

**NOTE:** S&T Shaft Diameter and Style are only available with Actuator Option angle 0, 6, 9, 2.



Dimensions are shown: Inch (mm)  
 Specifications and dimensions subject to change

# RTBV Series 1-2 Pole Coded Rotary Switches

DESIGNATION

## RTBV DIMENSIONAL DRAWINGS

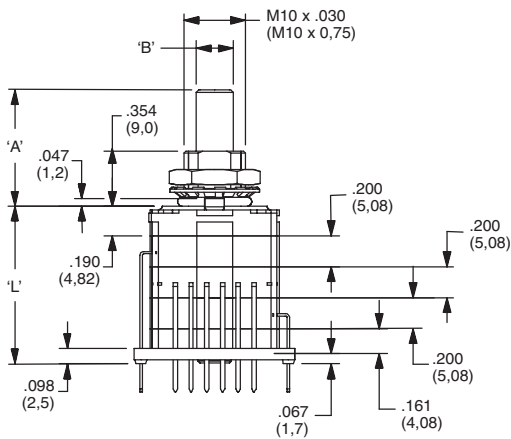
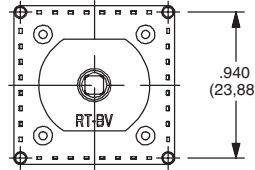
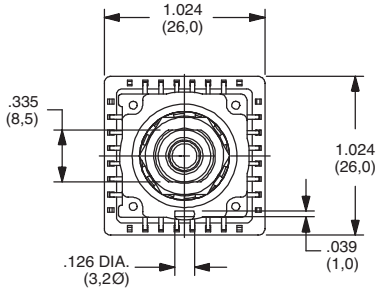

Dimensions L			
Number modules	inch	L mm	
<b>1</b>	0.419	10.65	
<b>2</b>	0.619	15.73	
<b>3</b>	0.819	20.81	
<b>4</b>	1.02	25.89	

**Dimensions A**  
A: (standard)  
0.984 inch (25 mm)

**Dimensions B**  
0.236 or 0.250 inch  
(Ø6 or 6.35 mm)

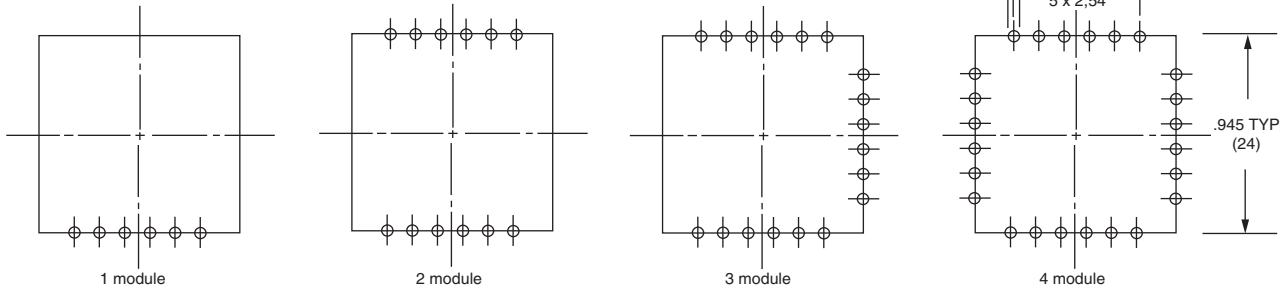

INDEXING

- 1** 15° index/24 positions
- 2** 22.5° index/16 positions
- 3** 30° index/12 positions
- 4** 36° index/10 positions



Dimensions are shown: mm  
Specifications and dimensions subject to change



K

Rotary

# RTBV Series

## 1-2 Pole Coded Rotary Switches

### NUMBER OF BANKS

- 1** 1 BANK
- 2** 2 BANKS
- 3** 3 BANKS
- 4** 4 BANKS

**NOTE:** Several functions can be combined. For more information consult customer service.

### SWITCH FUNCTION

Switch Function Number of Poles or code (binary code = B, complement = C, direct +complement = BC) (first digit), Stop (with=S, without=W), Maximum Position (third & fourth digit)

- |   |   |
|---|---|
| <b>1S02</b> SP, 02 positions with stop    | <b>1S24</b> SP, 24 positions with stop  |
| <b>1S03</b> SP, 03 positions with stop    | <b>1W24</b> SP, 24 positions without stop   |
| <b>1S04</b> SP, 04 positions with stop    | <b>2S04</b> DP, 4 positions with stop   |
| <b>1S05</b> SP, 05 positions with stop    | <b>2S05</b> DP, 5 positions with stop   |
| <b>1S06</b> SP, 06 positions with stop    | <b>2S06</b> DP, 6 positions with stop   |
| <b>1S07</b> SP, 07 positions with stop    | <b>GS_ _</b> Gray Code with stop (indicate position)  |
| <b>1S10</b> SP, 10 positions with stop    | <b>GW_ _</b> Gray Code without stop (indicate position) only can be 10,12, 16, 24 based on indexing         |
| <b>1W10</b> SP, 10 positions without stop | <b>BS_ _</b> Binary Code with stop (indicate position)  |
| <b>1S11</b> SP, 11 positions with stop    | <b>BW_ _</b> Binary Code without stop (indicate position) only can be 10,12, 16, 24 based on indexing       |
| <b>1S12</b> SP, 12 positions with stop    | <b>CS_ _</b> Complement with stop (indicate position)   |
| <b>1W12</b> SP, 12 positions without stop | <b>CW_ _</b> Complement without stop (indicate position) only can be 10,12, 16, 24 based on indexing        |
| <b>1S14</b> SP, 14 positions with stop    | <b>ES_ _</b> Direct+Complement with stop (indicate position)  |
| <b>1S16</b> SP, 16 positions with stop    | <b>EW_ _</b> Direct+Complement without stop (indicate position) only can be 10,12, 16, 24 based on indexing |
| <b>1W16</b> SP, 16 positions without stop |   |

#### 1 Single Pole Function 1S10, 1S12, 1S16, 1S24

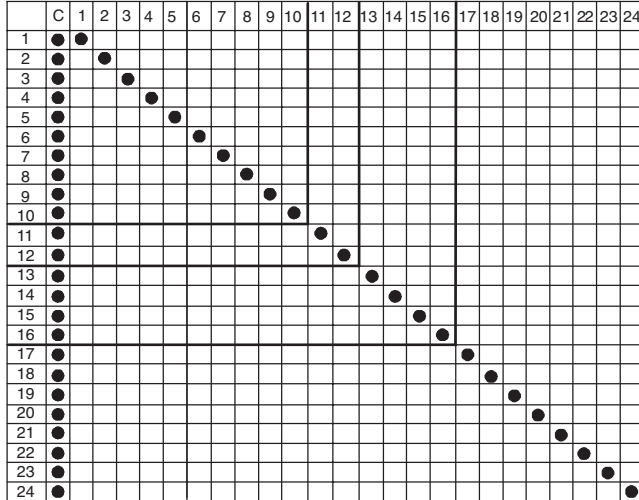

**1S10**

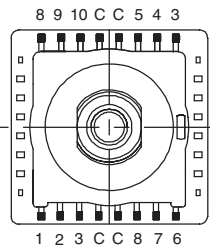

**1S12**

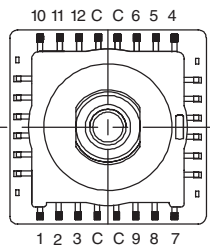

**1S16**

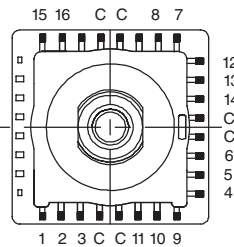

**1S24**

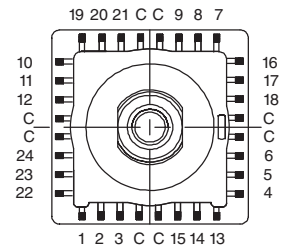

Dimensions are shown: Inch (mm)  
Specifications and dimensions subject to change



K

Rotary

# RTBV Series 1-2 Pole Coded Rotary Switches

## SWITCH FUNCTION

### 2 DOUBLE POLE FUNCTION

	C <sub>1</sub>	1 <sub>1</sub>	2 <sub>1</sub>	3 <sub>1</sub>	4 <sub>1</sub>	5 <sub>1</sub>	6 <sub>1</sub>	C <sub>2</sub>	1 <sub>2</sub>	2 <sub>2</sub>	3 <sub>2</sub>	4 <sub>2</sub>	5 <sub>2</sub>	6 <sub>2</sub>
1	●	●						●	●					
2	●		●					●		●				
3	●			●				●			●			
4	●				●			●				●		
5	●					●		●					●	
6	●						●	●						●

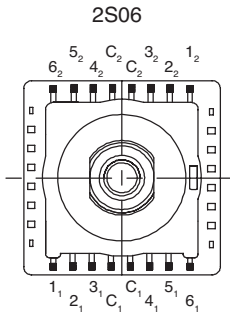

### B BINARY DIRECT CODE

	C	1	2	4	8	16
0	●	●	●	●	●	●
1	●	●	●	●	●	
2	●	●	●	●		
3	●	●	●			
4	●	●		●		
5	●	●			●	
6	●	●				●
7	●	●				
8	●		●			
9	●		●			
10	●			●		
11	●			●		
12	●				●	
13	●				●	
14	●					●
15	●					●
16	●					
17	●					
18	●					
19	●					
20	●					
21	●					
22	●					
23	●					

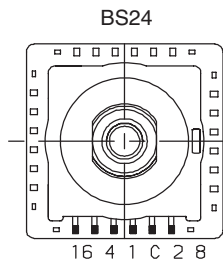
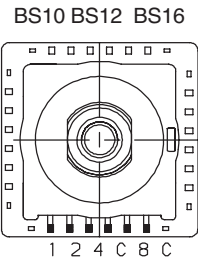

### C COMPLEMENT BINARY CODE

	c	$\bar{1}$	$\bar{2}$	$\bar{4}$	$\bar{8}$	$\bar{16}$
0	●	●	●	●	●	●
1	●	●	●	●	●	
2	●	●	●	●		
3	●	●	●			
4	●	●		●		
5	●	●			●	
6	●	●				●
7	●	●				
8	●		●			
9	●		●			
10	●			●		
11	●			●		
12	●				●	
13	●				●	
14	●					●
15	●					●
16	●					
17	●					
18	●					
19	●					
20	●					
21	●					
22	●					
23	●					

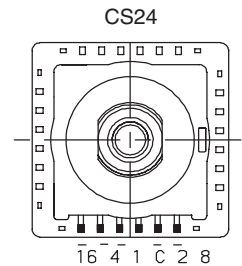
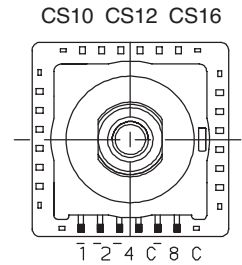

### G GRAY CODE

	C	1	2	3	4	5
1	●	●	●	●	●	●
2	●	●	●	●	●	
3	●	●	●	●		
4	●	●	●		●	
5	●	●	●			●
6	●	●		●		
7	●	●		●		
8	●	●			●	
9	●	●			●	
10	●		●			
11	●		●			
12	●			●		
13	●			●		
14	●				●	
15	●				●	
16	●					●
17	●					●
18	●					
19	●					
20	●					
21	●					
22	●					
23	●					
24	●					

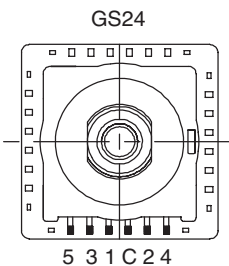
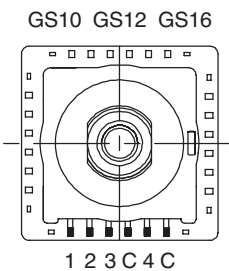

### E DIRECT AND COMPLEMENT BINARY CODE

	C	1	2	4	8	16	c	$\bar{1}$	$\bar{2}$	$\bar{4}$	$\bar{8}$	$\bar{16}$
0	●	●	●	●	●	●	●	●	●	●	●	●
1	●	●	●	●	●		●	●	●	●	●	
2	●	●	●	●			●	●	●	●		
3	●	●	●				●	●	●			
4	●	●		●			●	●		●		
5	●	●			●		●	●			●	
6	●	●				●	●	●				●
7	●	●					●	●				●
8	●		●				●		●			
9	●		●				●		●			
10	●			●			●			●		
11	●			●			●			●		
12	●				●		●				●	
13	●				●		●				●	
14	●					●	●					●
15	●						●					●
16	●							●				
17	●							●				
18	●							●				
19	●							●				
20	●							●				
21	●							●				
22	●							●				
23	●							●				

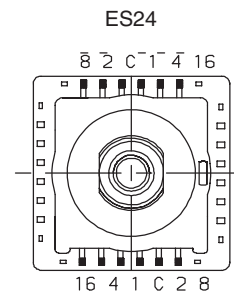
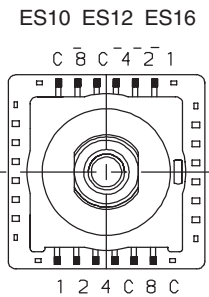

Third Angle Projection  
Dimensions are shown: mm  
Specifications and dimensions subject to change



K

Rotary

# RTBV Series 1-2 Pole Coded Rotary Switches

## SEAL

**A** STANDARD BUSHING FOR PANEL MOUNT

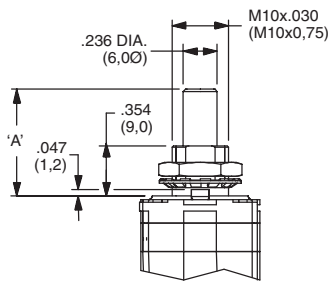

**D** SEALED BUSHING FOR PANEL MOUNT

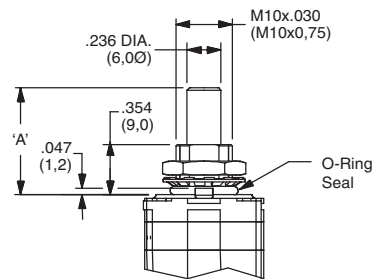

## SHAFT DIAMETER & STYLE

**N** METRIC SHAFT 0.236 (6,0)

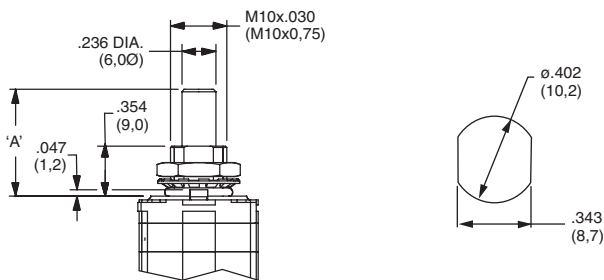

**P** STANDARD SHAFT 0.250 (6,35)

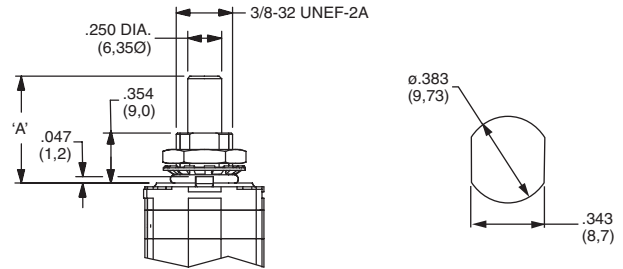

**F** METRIC SHAFT WITH FLAT 0.236 (6,0)

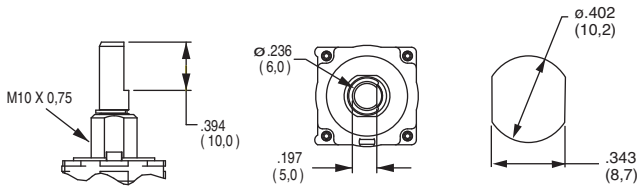

**G** STANDARD SHAFT WITH FLAT 0.250 (6,35)

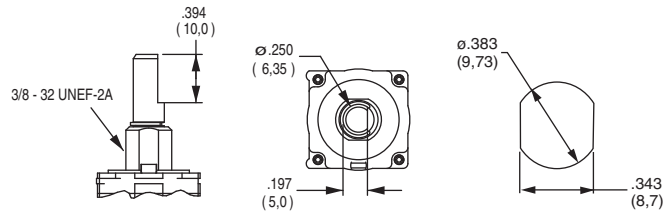

**S** METRIC SHAFT WITH SLOT 0.236 (6,0)

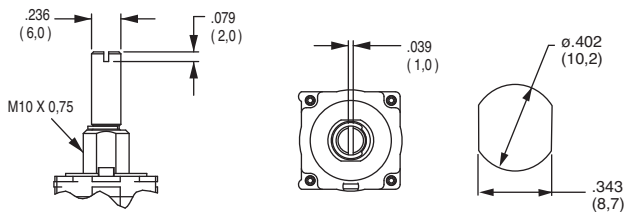

**T** STANDARD SHAFT WITH SLOT 0.250 (6,35)

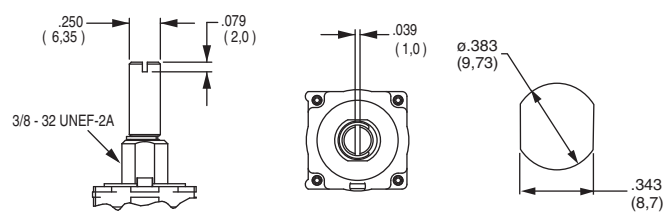

\*\*\*Note: Metric diameter shafts are only available with metric diameter bushings, standard 1.250 inch diameter shafts are only available with standard 3/8 diameter bushings.



Third Angle  
Projection

Dimensions are shown: Inch (mm)  
Specifications and dimensions subject to change

# RTBV Series 1-2 Pole Coded Rotary Switches

## ACTUATOR OPTION ANGLE

SHAFT WITH FLAT OPTIONS

**N (None)** FOR ACTUATORS WITHOUT A FLAT

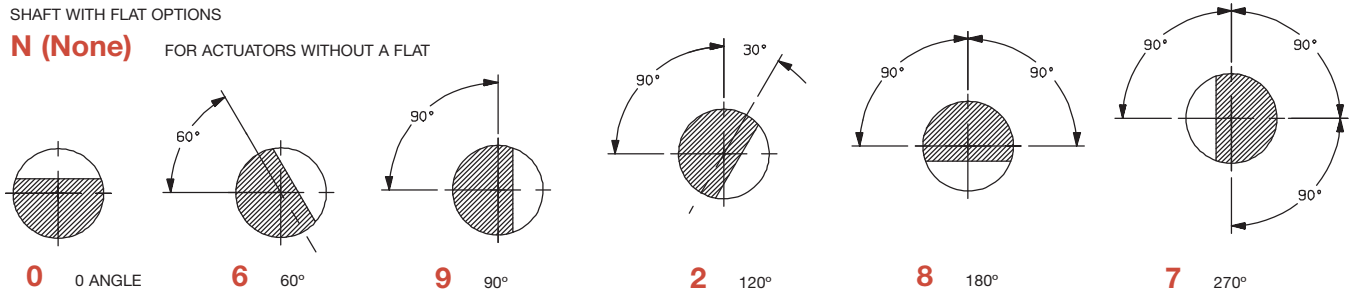

SHAFT WITH SLOT OPTIONS

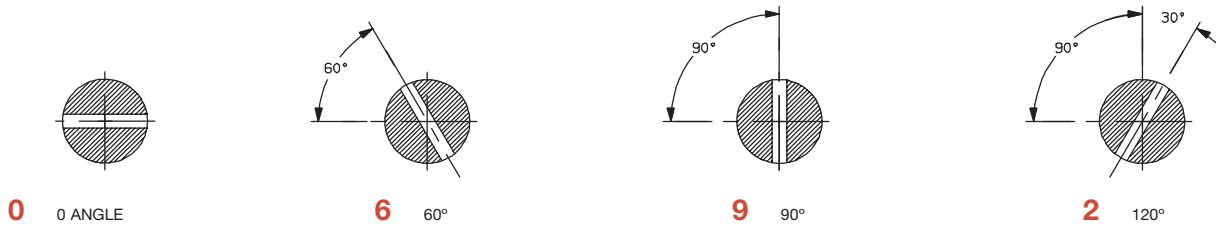

\* Note: S&T Shaft Diameter and Style are only available with Actuator Option Angle 0, 6, 9, 2.

## ACTUATOR LENGTH

**Z** (.984) 0,25 mm STANDARD SHAFT

Other lengths available by request.

## CONTACT MATERIAL

OPTION CODE	CONTACT AND TERMINAL MATERIAL	RATING
<b>S</b>	SILVER	SWITCH: 250 mA, POWER: 5 VA; CARRY: 5 AMPS
<b>P</b>	GOLD	SWITCH: 20 mA, POWER: 0.2 VA; CARRY: 1 AMP

\* Note: See Technical Data section of this catalog for RoHS compliant and compatible definition and specifications.

### SWITCHING POWER

**S** (SILVER CONTACTS)

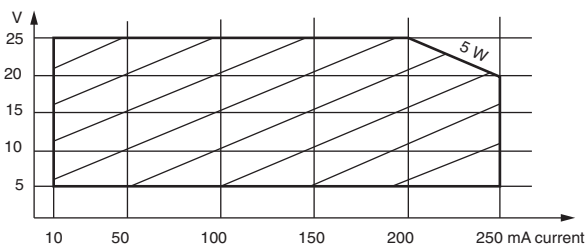

Switching power: 5 W  
Max. voltage: 25 V  
Min. voltage: 5 V  
Max. switching current: 250 mA  
Min. switching current: 10 mA

**P** (GOLD CONTACTS)

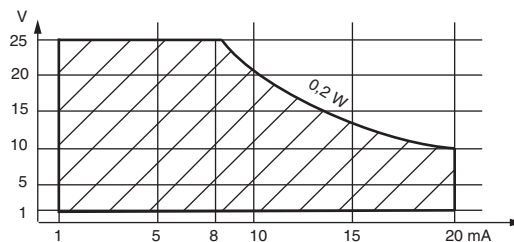

Switching power: 0.2 W  
Max. voltage: 25 V  
Min. voltage: 1 V  
Max. switching current: 20 mA  
Min. switching current: 1 mA



Dimensions are shown: mm  
Specifications and dimensions subject to change