

Energy Management Multifunction indicator Type WM12-96

CARLO GAVAZZI



- Accuracy ± 0.5 F.S. (current/voltage)
- Multifunction indicator
- Display of instantaneous variables: 3x3 digit
- Variable system and phase measurements: W, W_{dmd} , var, VA, VA_{dmd} , PF, V, A, An, Hz
- A_{max} , $W_{dmd\ max}$ indication
- TRMS meas. of distorted sine waves (voltages/currents)
- Power supply: 24V, 48V, 115V, 230V, 50-60Hz; 18 to 60VDC
- Protection degree (front): IP65
- Front dimensions: 96x96mm
- Optional RS422/485 serial output
- Alarms (visual only) V_{LN} , An

Product Description

3-phase multifunction power indicator with built-in programming key-pad. Particularly recommended for displaying the main electrical variables.

Housing for panel mounting, (front) protection degree IP65 as standard, and optional RS485 serial output.

How to order

WM12-96 AV5 3 D X

Model _____
 Range code _____
 System _____
 Power supply _____
 Option _____

Type Selection

| Range codes | System | Power supply | Options |
|---|---|---|--|
| AV5: 380/660 V_{L-L} /5(6)AAC VL-N: 185 V to 460 V VL-L: 320 V to 800 V AV6: 120/208 V_{L-L} /5(6)AAC VL-N: 45 V to 145 V VL-L: 78 V to 250 V Phase current: 0.03A to 6A Neutral current: 0.09 to 6A | 3: 1-2-3-phase, unbalanced load, with or without neutral | A: 24VAC -15+10%, 50-60Hz B: 48VAC -15+10%, 50-60Hz C: 115VAC -15+10%, 50-60Hz D: 230VAC -15+10%, 50-60Hz 3: 18 to 60VDC | X: None S: RS485 output |

Input specifications

| | | |
|--|--|--|
| Rated inputs Current Voltage | 3 (shunt) 4 | Sampling rate 1400 samples/s @ 50Hz 1700 samples/s @ 60Hz |
| Accuracy (display, RS485) (@25°C $\pm 5^\circ\text{C}$, R.H. $\leq 60\%$) | with CT=1 and VT=1 AV5: 1150W-VA-var, FS:230VLN, 400VLL; AV6: 285W-VA-var, FS:57VLN, 100VLL | Display refresh time 700ms |
| Current Neutral current Phase-phase voltage Phase-neutral voltage Active and Apparent power, Power factor Reactive power | 0.25 to 6A: $\pm(0.5\% \text{ FS} + 1\text{DGT})$ 0.03A to 0.25A: $\pm 7\text{DGT}$ 0.25 to 6A: $\pm(1.5\% \text{ FS} + 1\text{DGT})$ 0.09A to 0.25A: $\pm 7\text{DGT}$ $\pm(1.5\% \text{ FS} + 1 \text{ DGT})$ $\pm(0.5\% \text{ FS} + 1 \text{ DGT})$ | Display Type Read-out for the instant. var. LED, 14mm 3x3 DGT |
| Frequency | 0.25 to 6A: $\pm(2\% \text{ FS} + 1\text{DGT})$; 0.03A to 0.25A: $\pm(2\% \text{ FS} + 5\text{DGT})$ $\pm 0.1\% \text{ Hz}$ (48 to 62Hz) | Measurements Current, voltage, power, power factor, frequency TRMS measurement of distorted waves. Direct < 3, max 10A peak |
| Additional errors Humidity | $\leq 0.3\% \text{ FS}$, 60% to 90% RH | Input impedance 380/660 V_{L-L} (AV5) 120/208 V_{L-L} (AV6) Current $1 \text{ M}\Omega \pm 5\%$ $453 \text{ K}\Omega \pm 5\%$ $\leq 0.02\Omega$ |
| Temperature drift | $\leq 200 \text{ ppm}/^\circ\text{C}$ | Frequency 48 to 62 Hz |
| | | Overload protection Continuous voltage/current For 500ms: voltage/current 1.2 F.S. 2 Un/36A |



RS485 Serial Output Specifications

| | | | |
|---------------------------------|---|---|---|
| RS422/RS485 (on request) | | Data (bidirectional) Dynamic (reading only) Static (writing only) | System and phase variables All configuration parameters 1 bit di start , 8 data bit, no parity, 1 stop bit 9600 bit/s |
| Type | Multidrop bidirectional (static and dynamic variables) | Data format | |
| Connections | 2 or 4 wires, max. distance 1200m, termination directly on the instrument | Baud-rate | |
| Addresses Protocol | 1 to 255, key-pad selectable MODBUS/JBUS | | |

Software functions

| | | | |
|--------------------------|--|---|---|
| Password | Numeric code of max. 3 digits; 2 protection levels of the programming data Password "0", no protection | Displaying 3-phase system with neutral | Up to 3 variables per page Page 1: V L1, V L2, V L3 Page 2: V L12, V L23, V L31 Page 3: A L1, A L2, A L3 Page 4: An Page 5: W L1, W L2, W L3 Page 6: PF L1, PF L2, PF L3 Page 7: var L1, var L2, var L3 Page 8: VA L1, VA L2, VA L3 Page 9: VA Σ , W Σ , var Σ Page 10: VA dmd, W dmd, Hz Page 11: Wdmd MAX Page 12: VL-L Σ , PF Σ Page 13: A MAX |
| 1st level | Password "0", no protection | | |
| 2nd level | Password from 1 to 999, all data are protected | | |
| System selection | 3-phase with neutral 3-phase without neutral 3-phase ARON 2-phase Single phase | | |
| Transformer ratio | | | |
| CT | 1 to 999 | | |
| VT | 1.0 to 99.9 | | |
| Filter | | Alarms | |
| Operating range | 0 to 99.9% of the input electrical scale | Programmable, for the VL Σ and An (neutral current). Note: the alarm is only visual, by means of LED on the front of the instrument. | |
| Filtering coefficient | 1 to 16 | | |
| Filter action | Measurements, alarms, serial output (fundamental variables: V, A, W and their derived ones). | Reset | |
| | | Independent alarm (VL Σ , An) max: A, Wdmd | |

Power Supply Specifications

| | | | |
|-------------------------------|--|--------------------------|---|
| Auxiliary power supply | 230VAC -15 +10%, 50-60Hz 115VAC -15 +10%, 50-60Hz 48VAC -15 +10%, 50-60Hz | Power consumption | 24VAC -15 +10%, 50-60Hz 18 to 60VDC AC: 4.5 VA DC: 4W |
|-------------------------------|--|--------------------------|---|

General Specifications

| | | | |
|----------------------------------|---|----------------------------|---|
| Operating temperature | -5 to +50°C (23 to 122°F) (RH < 90% non condensing at 40°C) | RS485. | 500VAC/DC between measuring inputs and |
| Storage temperature | -30 to +60°C (-22 to 140°F) (RH < 90% non condensing at 40°C) | | 4000VAC, 500VDC between power supply and RS485 |
| Installation category | Cat. III (IEC 60664, EN60664) | Dielectric strength | 4000 VAC (for 1 min) |
| Insulation (for 1 minute) | 4000VAC, 500VDC between measuring inputs and power supply. | EMC Emissions | EN50084-1 (class A) residential environment, |

General Specifications (cont.)

| | | | |
|--|---|--------------------------------|--|
| Immunity | commerce and light industry EN61000-6-2 (class A) industrial environment. | Dimensions (WxHxD) Material | 96 x 96 x 63 mm ABS self-extinguishing: UL 94 V-0 |
| Pulse voltage (1.2/50µs) | EN61000-4-5 | Mounting | Panel |
| Safety standards | IEC60664, EN60664 | Protection degree | Front: IP65 (standard), NEMA4x, NEMA12 Connections: IP20 |
| Approvals | CE, cULus | Weight | Approx. 400 g (pack. incl.) |
| Connections 5(6) A Max cable cross sect. area | Screw-type 2.5 mm ² | | |
| Housing | | | |

Waveform of the signals that can be measured

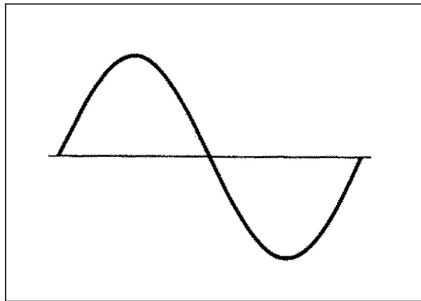

Figure A

Sine wave, undistorted

| | |
|---------------------|----------------|
| Fundamental content | 100% |
| Harmonic content | 0% |
| $A_{rms} =$ | $1.1107 A $ |

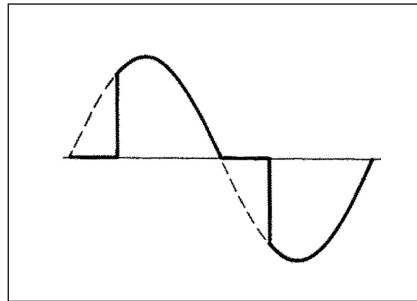

Figure B

Sine wave, indented

| | |
|---------------------|----------------------|
| Fundamental content | 10...100% |
| Harmonic content | 0...90% |
| Frequency spectrum: | 3rd to 16th harmonic |
| Additional error: | <1% FS |

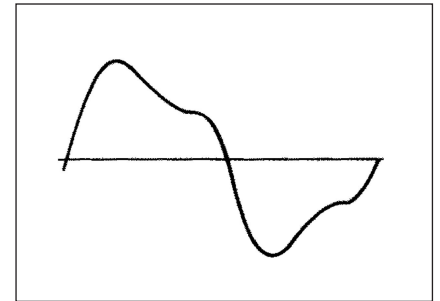

Figure C

Sine wave, distorted

| | |
|---------------------|----------------------|
| Fundamental content | 70...90% |
| Harmonic content | 10...30% |
| Frequency spectrum: | 3rd to 16th harmonic |
| Additional error: | <0.5% FS |

Display pages

Display variables in 3-phase systems (in a 3-phase system with neutral)

| No | 1 st variable | 2 nd variable | 3 rd variable | Note |
|----|--------------------------|--------------------------|--------------------------|---|
| 1 | V L1 | V L2 | V L3 | |
| 2 | V L12 | V L23 | V L31 | Decimal point blinking on the right of the display |
| 3 | A L1 | A L2 | A L3 | |
| 4 | An | AL.n | | AL.n if neutral current alarm is active |
| 5 | W L1 | W L2 | W L3 | Decimal point blinking on the right of the display if generated power |
| 6 | PF L1 | PF L2 | PF L3 | |
| 7 | VAR L1 | VAR L2 | VAR L3 | Decimal point blinking on the right of the display if generated power |
| 8 | VA L1 | VA L2 | VA L3 | |
| 9 | VA system | W system | VAR system | |
| 10 | VA dmd (system) | W dmd (system) | Hz (system) | dmd = demand (integration time selectable from 1 to 30 minutes) |
| 11 | | W dmd MAX | | Maximum sys power demand |
| 12 | V LL system | AL.U | PF system | AL.U= is activated only if one of VLN is not within the set limits |
| 13 | A MAX | | | max. current among the three phases |

Used calculation formulas

Phase variables

Instantaneous effective voltage

$$V_{IN} = \sqrt{\frac{1}{n} \cdot \sum_1^n (V_{IN})_i^2}$$

Instantaneous active power

$$W_1 = \frac{1}{n} \cdot \sum_1^n (V_{IN})_i \cdot (A_1)_i$$

Instantaneous power factor

$$\cos\phi_1 = \frac{W_1}{VA_1}$$

Instantaneous effective current

$$A_1 = \sqrt{\frac{1}{n} \cdot \sum_1^n (A_1)_i^2}$$

Instantaneous apparent power

$$VA_1 = V_{IN} \cdot A_1$$

Instantaneous reactive power

$$VAR_1 = \sqrt{(VA_1)^2 - (W_1)^2}$$

System variables

Equivalent 3-phase voltage

$$V_{\Sigma} = \frac{V_1 + V_2 + V_3}{3} \cdot \sqrt{3}$$

3-phase reactive power

$$VAR_{\Sigma} = (VAR_1 + VAR_2 + VAR_3)$$

3-phase active power

$$W_{\Sigma} = W_1 + W_2 + W_3$$

3-phase apparent power

$$VA_{\Sigma} = \sqrt{W_{\Sigma}^2 + VAR_{\Sigma}^2}$$

3-phase power factor

$$\cos\phi_{\Sigma} = \frac{W_{\Sigma}}{VA_{\Sigma}}$$

Neutral current

$$An = \bar{A}_{L1} + \bar{A}_{L2} + \bar{A}_{L3}$$

F1= 315mA

Wiring diagrams

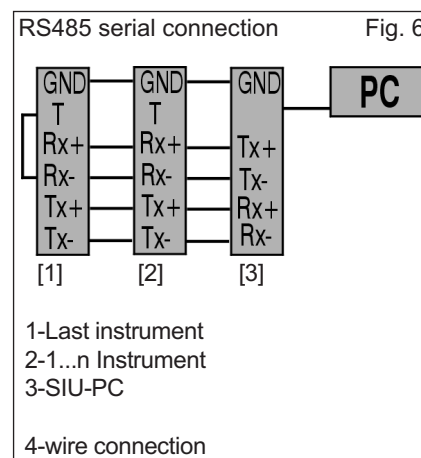
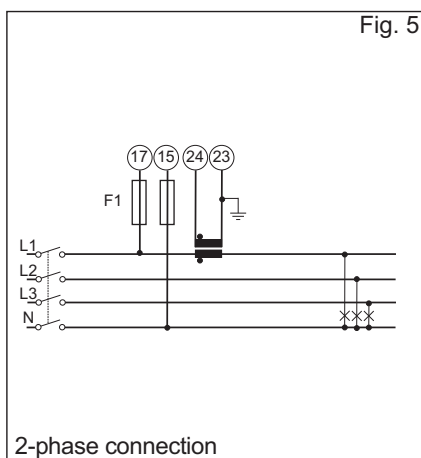
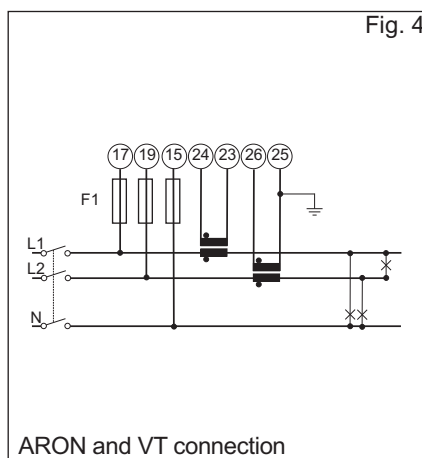
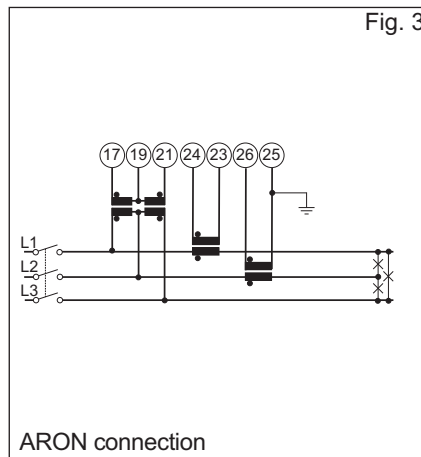
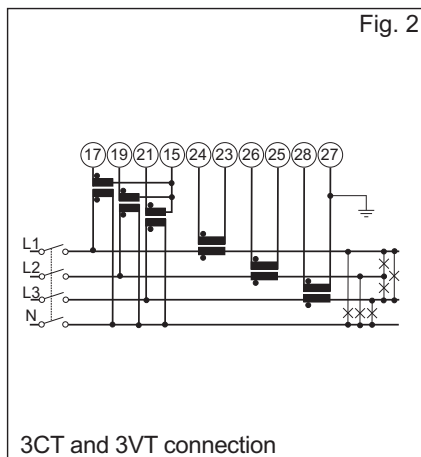
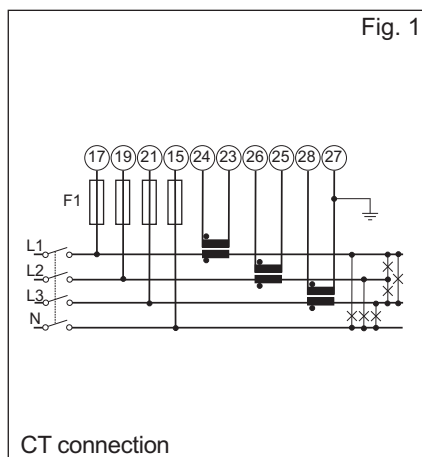

NOTE: the current inputs can be connected to the lines **ONLY** by means of current transformers. The direct connection is not allowed.

ATTENTION: Only one ammeter input can be connected to earth, as shown in the electrical diagrams.

Front Panel Description

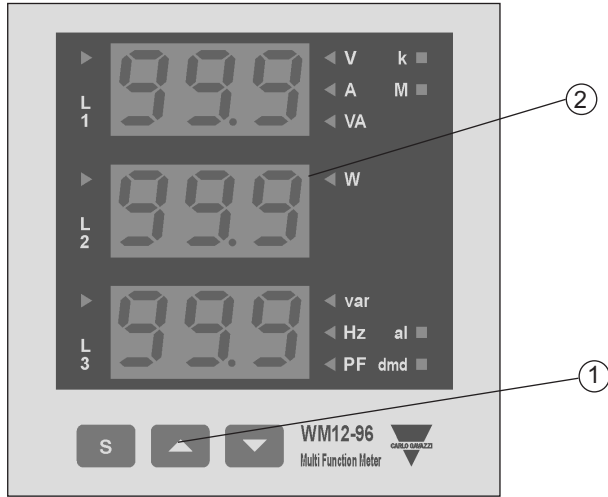

1. Key-pad

To program the configuration parameters and the display of the variables.



Key to enter programming and confirm selections;



Keys to:

- programme values;
- select functions;
- display measuring pages.

2. Display

LED-type with alphanumeric indications to:

- display configuration parameters;
- display all the measured variables.

Dimensions and Panel Cut-out

