

SERPAC A-42

Electronic Enclosures

NOTES:

1. WHEN MACHINING OR "I" PLATE MODIFICATIONS ARE REQUIRED, DIMENSION FROM THE CENTER OF THE ENCLOSURE

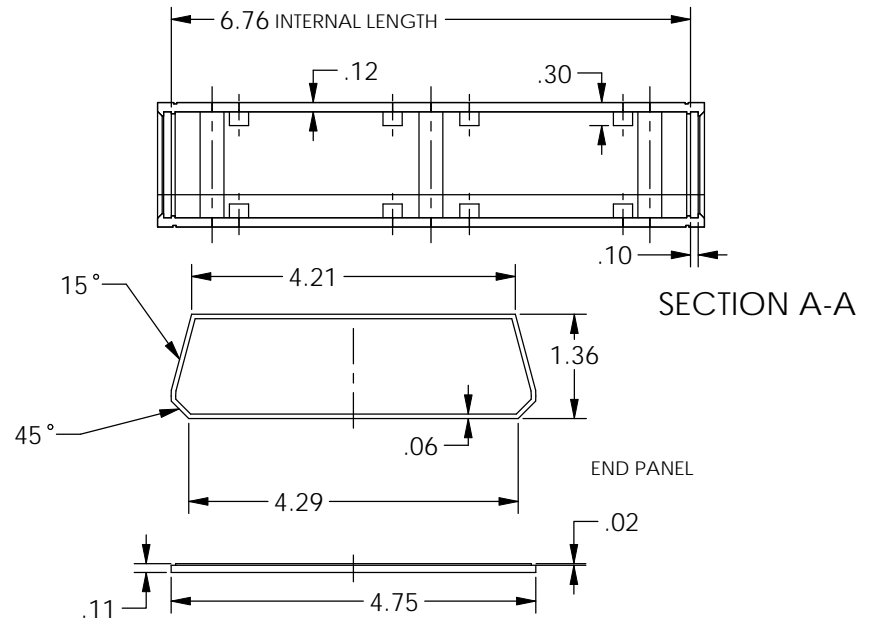
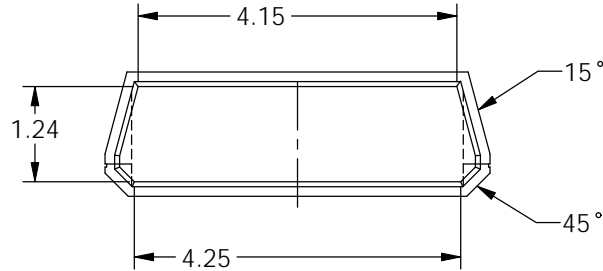
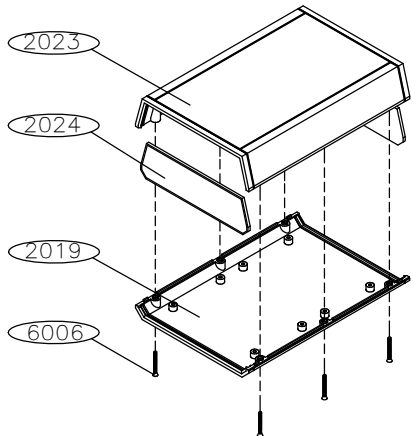
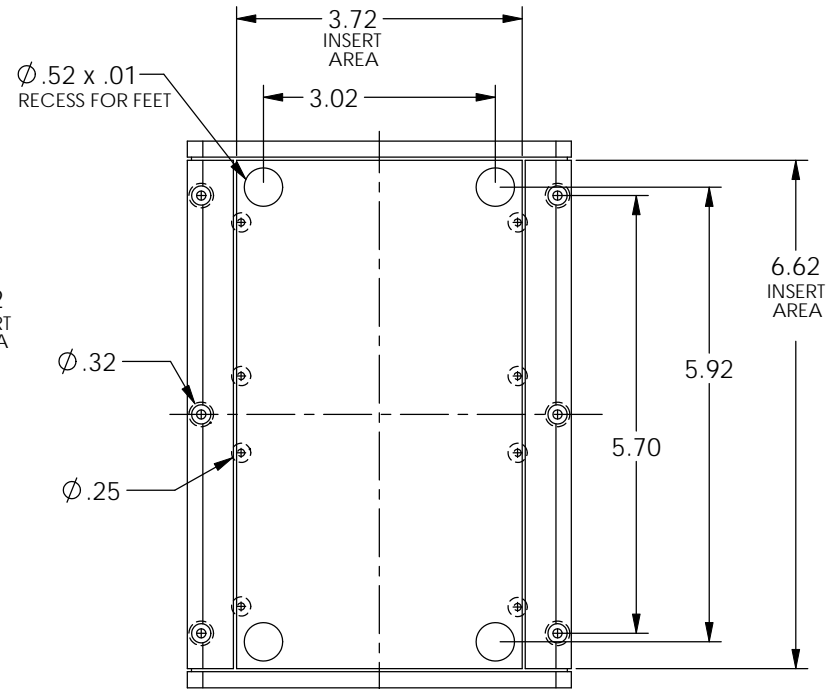
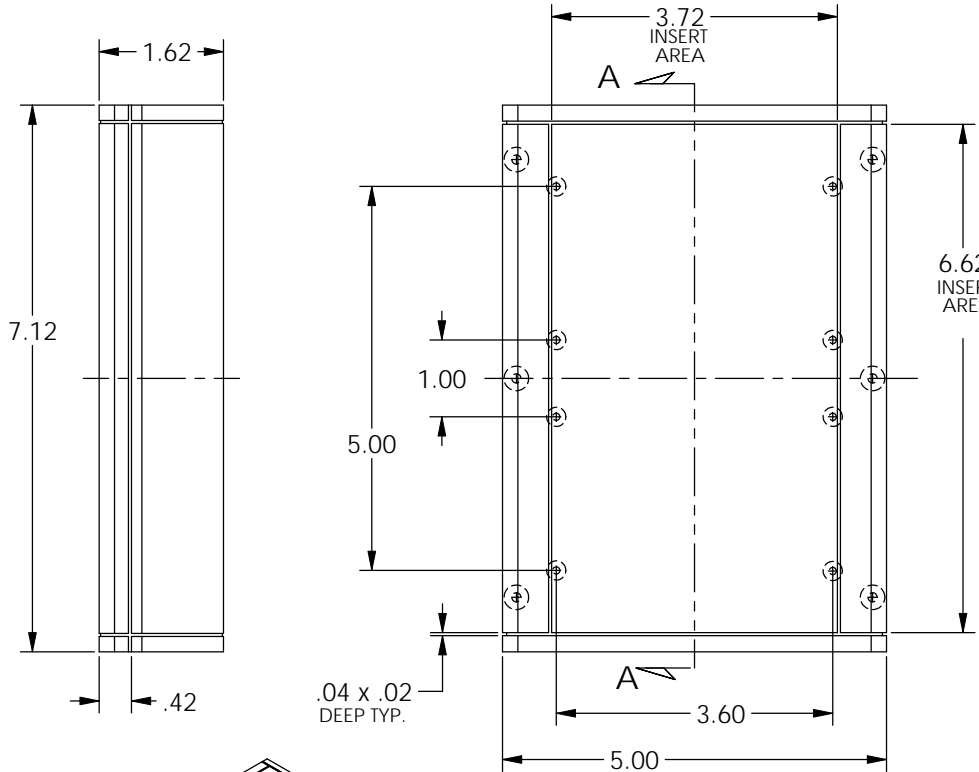

PART NO.	DESCRIPTION	PART NO.	ACCESSORIES (NOT SHOWN)
2023	TOP	51	FEET
2024	END PANEL	2024IR	INFRARED PANEL
2019	BOTTOM	2024CL	CLEAR PANEL
6006	SCREW	2024DB9	DB9 CUTOUT PANEL
		2024DB25	DB25 CUTOUT PANEL