



Parameter	Rating	Units
Blocking Voltage	600	V_P
Load Current	0.5	A_{rms} / A_{DC}
On-Resistance (max)	6	Ω
Input / Output Isolation	4	kV

Features

- 4000V_{rms} Input/Output Isolation
- Handle Load Currents Up to 0.5A
- 600V_P Blocking Voltage
- Power SIP Package
- High Reliability
- No Moving Parts
- Low Drive Power Requirements (TTL/CMOS Compatible)
- Arc-Free With No Snubbing Circuits
- No EMI/RFI Generation
- Machine Insertable, Wave Solderable

Applications

- Industrial Controls
- Motor Control
- Robotics
- Medical Equipment—Patient/Equipment Isolation
- Instrumentation
 - Multiplexers
 - Data Acquisition
 - Electronic Switching
 - I/O Subsystems
- Meters (Watt-Hour, Water, Gas)
- IC Equipment
- Home Appliances

Pin Configuration

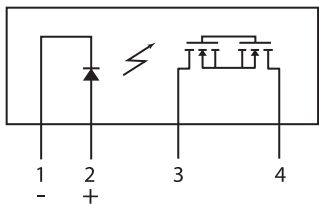

Description

IXYS Integrated Circuits Division and its parent, IXYS, have combined to bring OptoMOS® technology, reliability, and compact size to a new family of high-power Solid State Relays.

As part of this family, the CPC1983YE single-pole normally open (1-Form-A) Solid State Power Relay is rated for up to 0.5A_{DC} / 0.5A_{rms} continuous load current.

The CPC1983YE employs optically coupled MOSFET technology to provide 4000V_{rms} of input to output isolation. The optically coupled outputs, that use patented OptoMOS architecture, are controlled by a highly efficient GaAlAs infrared LED.

This combination of low on-resistance and high load current handling capability makes this relay suitable for a variety of high performance switching applications.

The "E" suffix signifies an enhanced isolation voltage.

Approvals

- UL Recognized Component: File E69938

Ordering Information

Part #	Description
CPC1983YE	Power SIP Package (25 per tube)

Switching Characteristics of Normally Open Devices

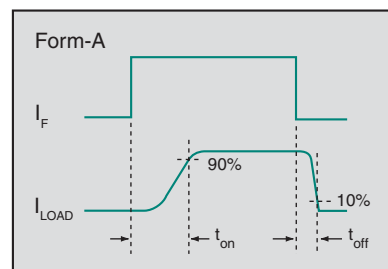

Absolute Maximum Ratings @ 25°C

Parameter	Ratings	Units
Blocking Voltage	600	V _P
Reverse Input Voltage	5	V
Input Control Current	50	mA
Peak (10ms)	1	A
Input Power Dissipation ¹	150	mW
Total Power Dissipation ²	1600	mW
Isolation Voltage, Input to Output ³	4000	V _{rms}
ESD Rating, Human Body Model	8	kV
Operational Temperature	-40 to +85	°C
Storage Temperature	-40 to +125	°C

Absolute Maximum Ratings are stress ratings. Stresses in excess of these ratings can cause permanent damage to the device. Functional operation of the device at conditions beyond those indicated in the operational sections of this data sheet is not implied.

¹ Derate linearly 3.33 mW / °C

² Derate linearly 16.667 mW / °C

³ UL File 69938 is only rated by UL to 2500V_{rms}

Electrical Characteristics @ 25°C

Parameter	Conditions	Symbol	Min	Typ	Max	Units
Output Characteristics						
Load Current, Continuous	I _F =5mA, Free air	I _L	-	-	0.5	A _{rms} / A _{DC}
Peak Load Current	I _F =5mA, t=10ms	I _{LPK}	-	-	±3	A _P
On-Resistance ¹	I _F =5mA, I _L =0.5A	R _{ON}	-	3.5	6	Ω
Off-State Leakage Current	I _F =0mA, V _L =600V _P	I _{LEAK}	-	-	1	μA
Switching Speeds						
Turn-On	I _F =5mA, V _L =10V	t _{on}	-	2.2	5	ms
Turn-Off		t _{off}	-	0.15	2	
Output Capacitance	I _F =0mA, 50V, f=1MHz	C _{OUT}	-	41	-	pF
Input Characteristics						
Input Control Current to Activate	I _L =0.5A	I _F	-	1.3	5	mA
Input Control Current to Deactivate	-	I _F	0.5	-	-	mA
Input Voltage Drop	I _F =5mA	V _F	0.9	1.2	1.4	V
Reverse Input Current	V _R =5V	I _R	-	-	10	μA
Input/Output Characteristics						
Capacitance Input/Output	f=1MHz	C _{IO}	-	2	-	pF

¹ Measurement taken within 1 second of on-time.

Thermal Characteristics

Parameter	Conditions	Symbol	Min	Typ	Max	Units
Thermal Resistance (junction to case)	-	R _{θJC}	-	1.5	-	°C/W

PERFORMANCE DATA *

Typical LED Forward Voltage Drop
(N=50, $I_F=5\text{mA}$, $T_A=25^\circ\text{C}$)

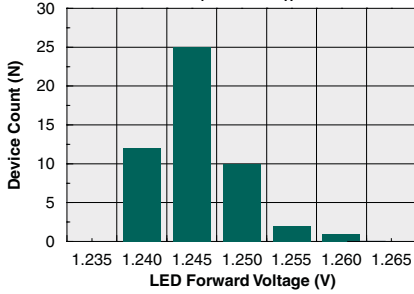

Typical Turn-On Time
(N=50, $I_F=5\text{mA}$, $I_L=75\text{mA}$, $T_A=25^\circ\text{C}$)

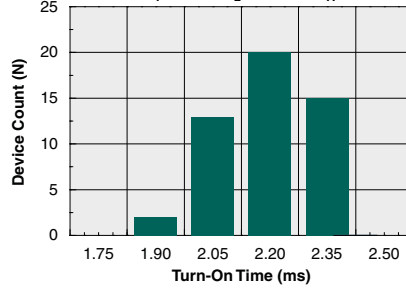

Typical Turn-Off Time
(N=50, $I_F=5\text{mA}$, $I_L=75\text{mA}$, $T_A=25^\circ\text{C}$)

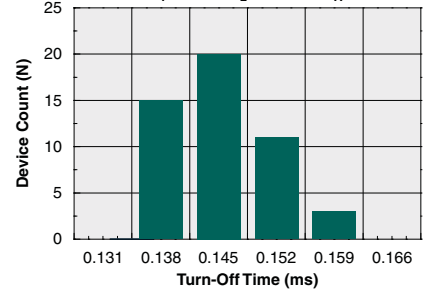

Typical I_F for Switch Operation
(N=50, $I_L=500\text{mA}$, $T_A=25^\circ\text{C}$)

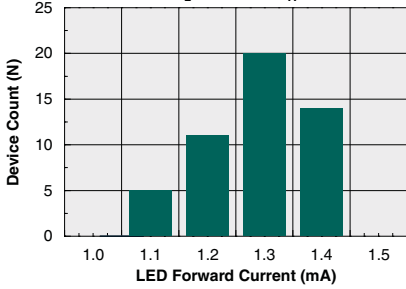

Typical On-Resistance Distribution
(N=50, $I_F=5\text{mA}$, $I_L=500\text{mA}$, $T_A=25^\circ\text{C}$)

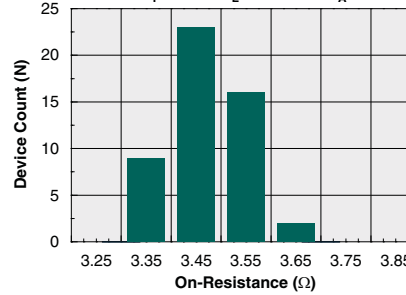

Typical Blocking Voltage Distribution
(N=50, $I_F=0\text{mA}$, $T_A=25^\circ\text{C}$)

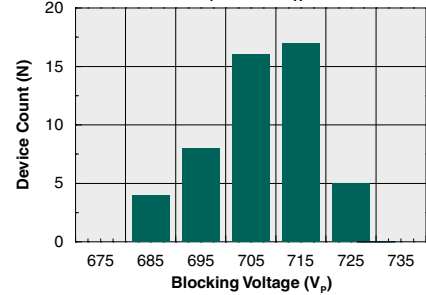

Typical LED Forward Voltage Drop vs. Temperature

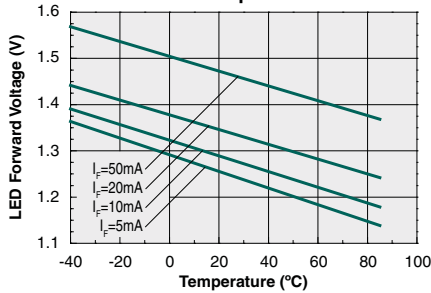

Typical Turn-On Time vs. LED Forward Current
($I_L=75\text{mA}$, $T_A=25^\circ\text{C}$)

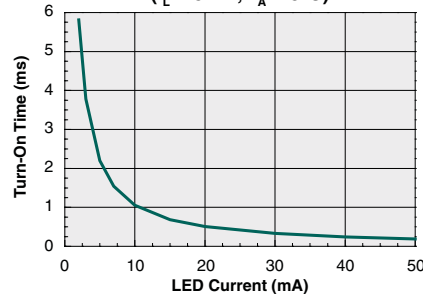

Typical Turn-Off Time vs. LED Forward Current
($I_L=75\text{mA}$, $T_A=25^\circ\text{C}$)

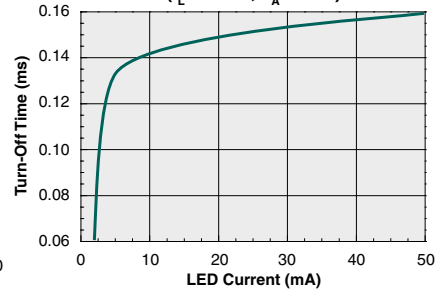

Typical I_F for Switch Operation vs. Temperature
($I_L=300\text{mA}$)

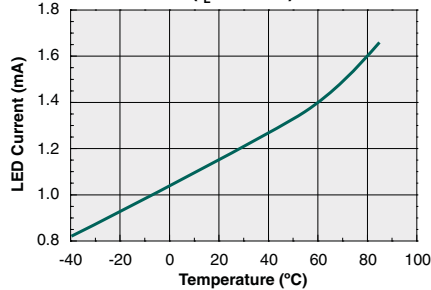

Typical Turn-On Time vs. Temperature
($I_L=75\text{mA}$)

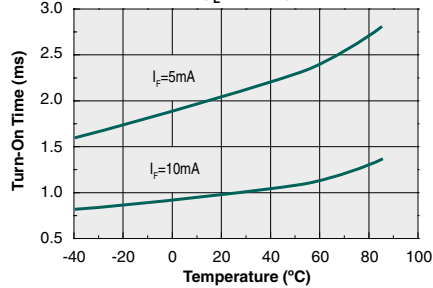

Typical Turn-Off Time vs. Temperature
($I_L=75\text{mA}$)

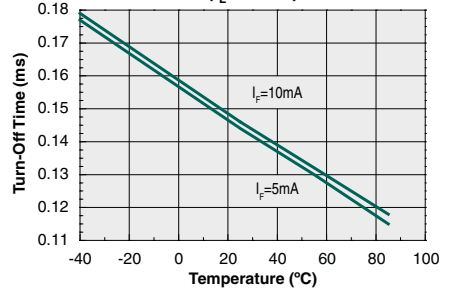

*The Performance data shown in the graphs above is typical of device performance. For guaranteed parameters not indicated in the written specifications, please contact our application department.

PERFORMANCE DATA*

Typical On-Resistance vs. Temperature
($I_F=5\text{mA}$, $I_L=300\text{mA}$)

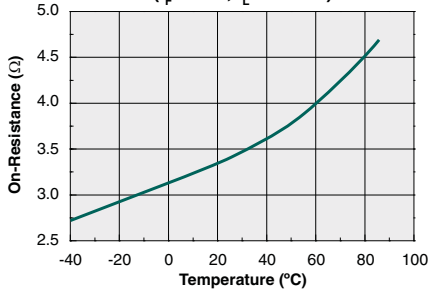

Typical Load Current vs. Load Voltage
($I_F=5\text{mA}$, $T_A=25^\circ\text{C}$)

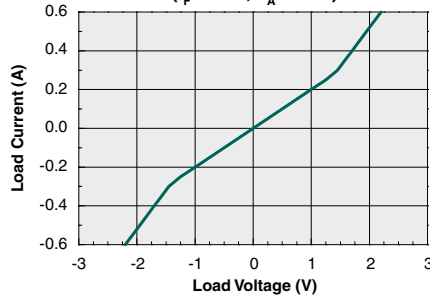

Maximum Load Current vs. Temperature
($I_F=5\text{mA}$)

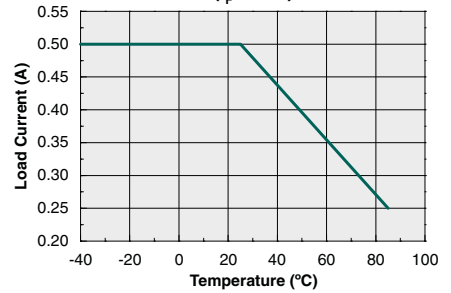

Typical Blocking Voltage vs. Temperature

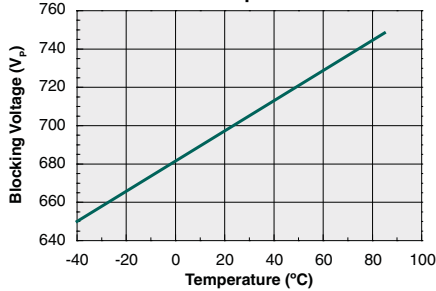

Typical Leakage Current vs. Temperature
($V_L=600\text{V}$)

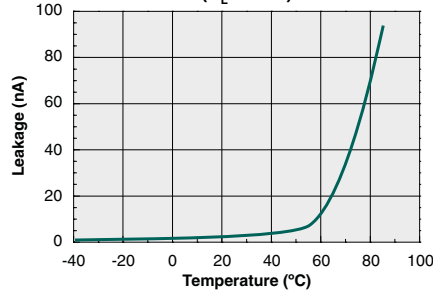

Output Capacitance vs. Load Voltage
($I_F=0\text{mA}$, $f=1\text{MHz}$, $T_A=25^\circ\text{C}$)

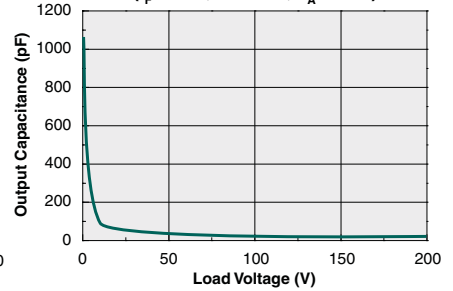

Energy Rating Curve

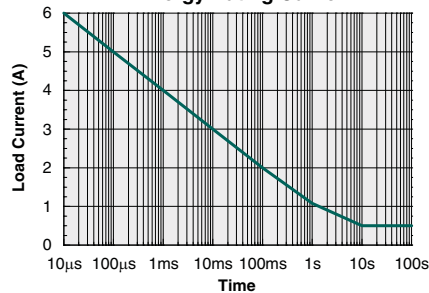

*The Performance data shown in the graphs above is typical of device performance. For guaranteed parameters not indicated in the written specifications, please contact our application department.

Manufacturing Information

Moisture Sensitivity



All plastic encapsulated semiconductor packages are susceptible to moisture ingress. IXYS Integrated Circuits Division classified all of its plastic encapsulated devices for moisture sensitivity according to the latest version of the joint industry standard, **IPC/JEDEC J-STD-020**, in force at the time of product evaluation. We test all of our products to the maximum conditions set forth in the standard, and guarantee proper operation of our devices when handled according to the limitations and information in that standard as well as to any limitations set forth in the information or standards referenced below.

Failure to adhere to the warnings or limitations as established by the listed specifications could result in reduced product performance, reduction of operable life, and/or reduction of overall reliability.

This product carries a **Moisture Sensitivity Level (MSL) rating** as shown below, and should be handled according to the requirements of the latest version of the joint industry standard **IPC/JEDEC J-STD-033**.

Device	Moisture Sensitivity Level (MSL) Rating
CPC1983YE	MSL 1

ESD Sensitivity



This product is **ESD Sensitive**, and should be handled according to the industry standard **JESD-625**.

Reflow Profile

This product has a maximum body temperature and time rating as shown below. All other guidelines of **J-STD-020** must be observed.

Device	Maximum Temperature x Time
CPC1983YE	245°C for 30 seconds

Board Wash

IXYS Integrated Circuits Division recommends the use of no-clean flux formulations. However, board washing to remove flux residue is acceptable. Since IXYS Integrated Circuits Division employs the use of silicone coating as an optical waveguide in many of its optically isolated products, the use of a short drying bake could be necessary if a wash is used after solder reflow processes. Chlorine- or Fluorine-based solvents or fluxes should not be used. Cleaning methods that employ ultrasonic energy should not be used.



MECHANICAL DIMENSIONS

CPC1983YE

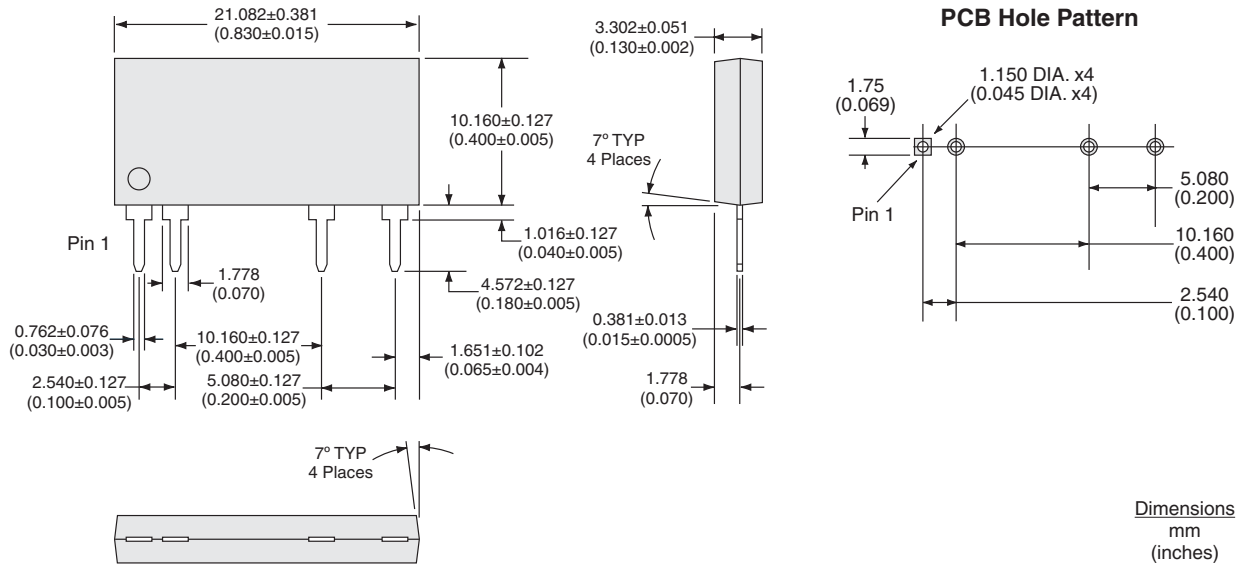

For additional information please visit our website at: www.ixysic.com

IXYS Integrated Circuits Division makes no representations or warranties with respect to the accuracy or completeness of the contents of this publication and reserves the right to make changes to specifications and product descriptions at any time without notice. Neither circuit patent licenses nor indemnity are expressed or implied. Except as set forth in IXYS Integrated Circuits Division's Standard Terms and Conditions of Sale, IXYS Integrated Circuits Division assumes no liability whatsoever, and disclaims any express or implied warranty, relating to its products including, but not limited to, the implied warranty of merchantability, fitness for a particular purpose, or infringement of any intellectual property right.

The products described in this document are not designed, intended, authorized or warranted for use as components in systems intended for surgical implant into the body, or in other applications intended to support or sustain life, or where malfunction of IXYS Integrated Circuits Division's product may result in direct physical harm, injury, or death to a person or severe property or environmental damage. IXYS Integrated Circuits Division reserves the right to discontinue or make changes to its products at any time without notice.

Specification: DS-CPC1983YE-R02
©Copyright 2012, IXYS Integrated Circuits Division
OptoMOS® is a registered trademark of IXYS Integrated Circuits Division
All rights reserved. Printed in USA.
12/17/2012