



**PART No. 1438-42**

for more information visit  
[www.hammfg.com](http://www.hammfg.com)  
Data subject to change without notice  
Isometric drawing Not to Scale



BACK VIEW

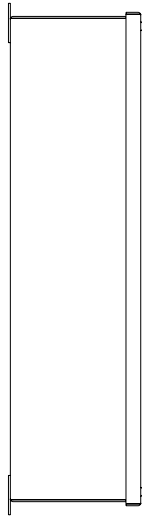

LEFT SIDE VIEW

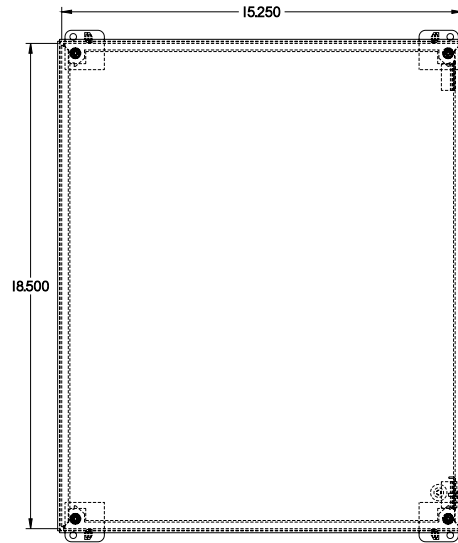

FRONT VIEW

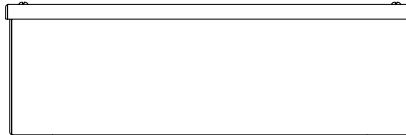

BOTTOM VIEW

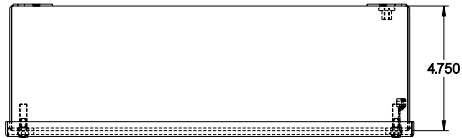

TOP VIEW

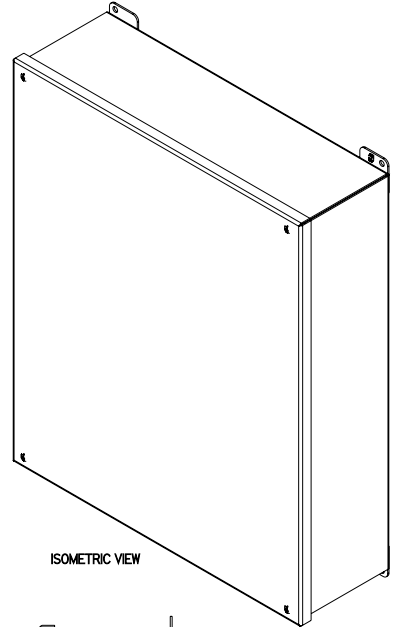

ISOMETRIC VIEW