

THESE DRAWINGS ARE THE PROPERTY OF QUALTEK ELECTRONICS AND NOT TO BE REPRODUCED FOR OR COMMUNICATED TO A THIRD PARTY WITHOUT THE EXPRESS WRITTEN PERMISSION OF AN OFFICER OF QUALTEK ELECTRONICS.

REVISION			
REV.	DESCRIPTION	DATE	APPROVED
B	Added Dimensions	09-09-08	LY

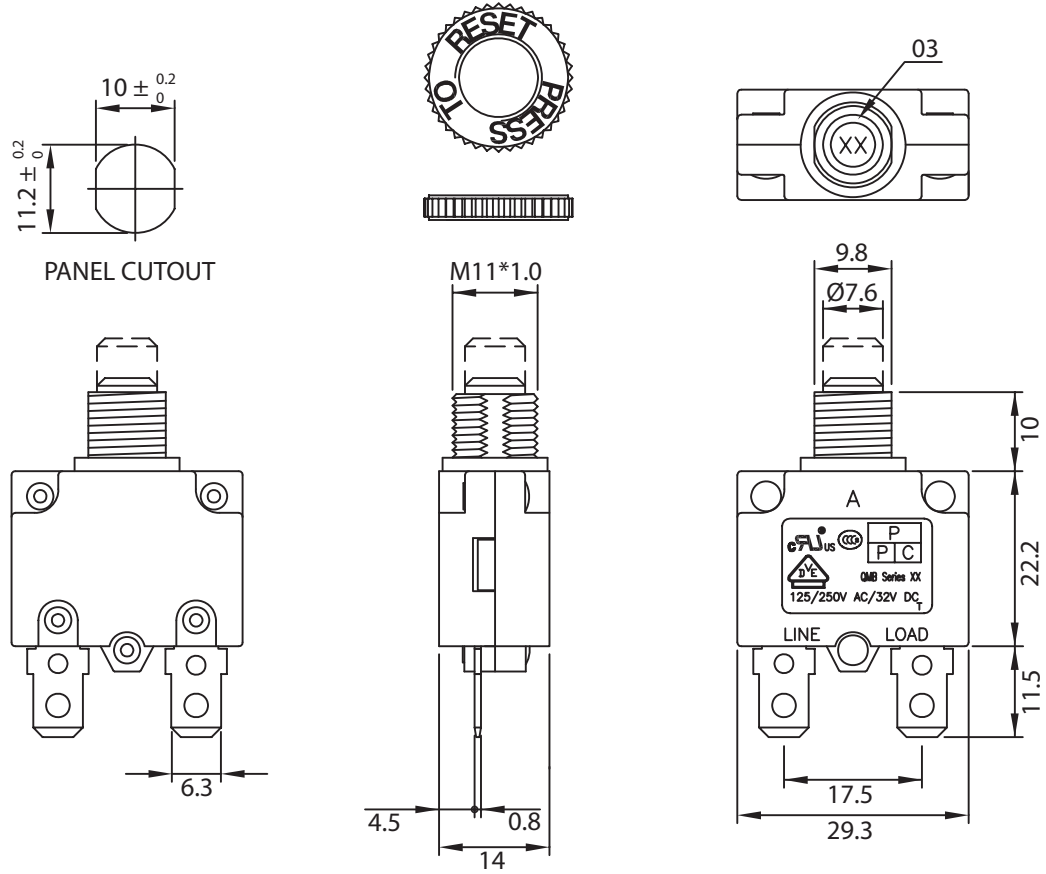

NOTES:

RATING: 3A 125-250V AC/32V DC  
 APPROVALS: UL, cUL, VDE, CCC, CE  
 RoHS COMPLIANT

**CONTROLLED**

Dim range (mm)	Tolerance +/- (mm)	Qualtek Electronics Corp. PPC DIVISION		
		Part Number: QMB-032-11C3N-3BA	RoHS Compliant	
0-1	0.15	Description: CIRCUIT BREAKER		
1-6	0.20			
6-18	0.30			
18-50	0.50			
50-120	0.70	Drawn / Date	UNIT: mm	REV. B
120-250	0.90	Checked / Date		Approved / Date
250-500	1.20	R.Nuti 06-03-08	06-03-08	LY / 06-03-08