



**Operation Manual: AS5601-SO\_RD\_ST**

# **AS5601**

**12-bit Programmable Contactless Potentiometer**

## Table of Contents

1	General Description .....	3
1.1	Kit Content .....	3
2	Getting Started .....	3
2.1	Adapter Board Pin-Out.....	3
2.2	Adapter Board Description.....	4
2.3	Mechanical Setup.....	4
2.4	Electrical Setup .....	6
2.4.1	Incremental Mode .....	6
2.4.2	Pushbutton Detection.....	6
2.4.3	I <sup>2</sup> C Mode .....	7
3	AS5601 Configuration .....	7
3.1	Programming the output range .....	7
3.2	Programming a configuration.....	7
3.2.1	Low Power Mode .....	8
3.2.2	Hysteresis .....	8
3.2.3	Output selection .....	8
3.2.4	Slow Filter .....	8
3.2.5	Fast Filter .....	8
3.2.6	Watchdog .....	8
4	Board Schematics, Layout and BOM.....	8
4.1	Schematics.....	8
4.2	Layout and Board Dimensions.....	9
4.3	Bill of Materials.....	9
5	Evaluation tools.....	10
6	Ordering Information .....	10
	Copyright .....	11
	Disclaimer .....	11

## Revision History

Revision	Date	Owner	Description
1.0	30.06.2014	rph	Initial Revision

## 1 General Description

The reference design allows an easy and fast evaluation of the AS5601 rotary magnetic position sensor in the lab. Additionally it is possible to replace an existing contactless rotary knob with the AS5601-SO\_RD\_ST. The module is fully assembled with and pcb including the AS5601 position sensor and its necessary external components. All relevant signals are available on a 7-way connector and can be easily wired to an existing application.

The AS5601 is an easy-to-program magnetic rotary position sensor with incremental quadrature (A/B) and 12-bit digital outputs. Additionally, the PUSH output indicates fast air gap changes between the AS5601 and magnet which can be used to implement a contactless pushbutton function in which the knob can be pressed to move the magnet toward the AS5601.

Based on planar Hall technology, this device measures the orthogonal component of the flux density ( $B_z$ ) from an external magnet while rejecting stray magnetic fields.

The I<sup>2</sup>C interface is used for configuration and user programming of non-volatile parameters in the AS5601 without requiring a dedicated programmer.

### 1.1 Kit Content

This kit contains following material listed in Table 1. Additional material can be found on our webpage.

Table 1:  
Kit Content

No.	Item	Description	Info
1	AS5601-SO_RD_ST		Reference Module including PCB
2	Quick Start Guide		

## 2 Getting Started

The AS5601 reference design is a contactless rotary knob with 16 mechanical positions and a pushbutton detection. It can be programmed over I<sup>2</sup>C.

**Note:** The AS5601 is configured for a 16 positions grid and for the modules zero position.

### 2.1 Adapter Board Pin-Out

The pin-out of the reference module pcb is shown in Table 2. For additional information on the AS5601 pins refer to the product datasheet.

Table 2:  
Adapter Board Pin-Out (J1)

Pin	Symbol	Description	Info
1	VDD	Positive Power Supply	
2	PUSH	Output Pin	Contactless push-button output
3	A	Output Pin	Incremental output A
4	B	Output Pin	Incremental output B
5	SDA	I2C Data	
6	SCL	I2C Clock	
7	GND	Ground	

## 2.2 Adapter Board Description

The AS5601 is connected over the 7-way header. Connect the desired pins of the AS5601 using the headers and resistors.

Figure 1:  
AS5601-SO\_RD\_ST PCB Description

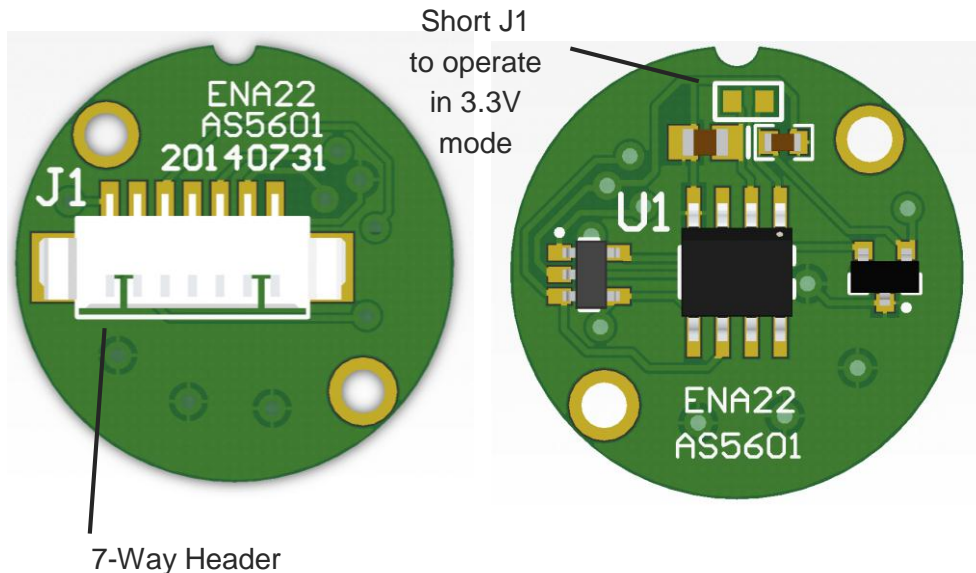

## 2.3 Mechanical Setup

The contactless potentiometer reference design comes with the AS5601-SO\_RD\_ST PCB assembled. The PCB holds all necessary components to operate the AS5601 in a contactless potentiometer application with additional Pushbutton Detection.

The set-up of the module is shown below.

Figure 2:  
Module set-up

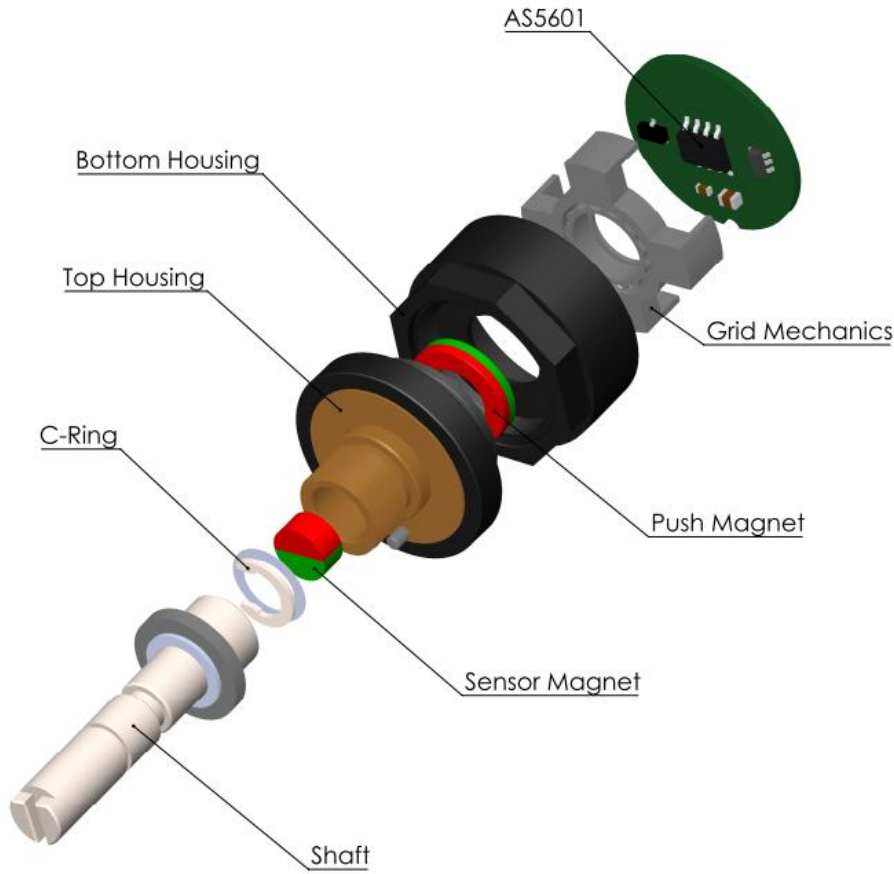

The configuration of the reference module is shown in Figure 3.

Figure 3:  
Module Cross-Section

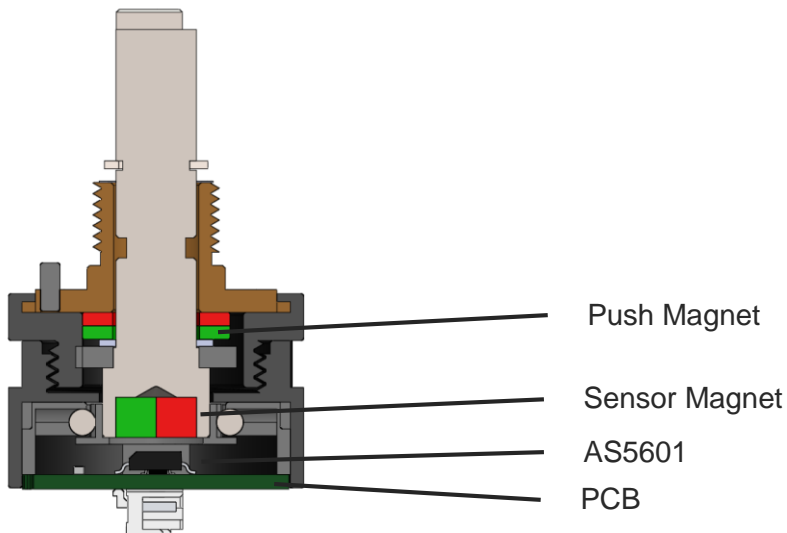

The magnet is already aligned to get AGC values in the middle of the AGC range.

**Note:** If the magnetic field seen by the AS5601 would be below 8mT, the output is disconnected and permanent angle programming would not be possible. The AB quadrature interface is not updated as long as the magnet is away.

## 2.4 Electrical Setup

The reference module is many used in following configurations and can be supplied with 5V or in 3.3V mode. Use J1 to enable the 3.3V mode.

### 2.4.1 Incremental Mode

In this mode, the power supply and the pins A and B of the reference module are connected. Over Programming interface the Zero position and the resolution can be configured for better performance due to hardly any individual application.

Figure 4:  
Using the board in incremental Mode

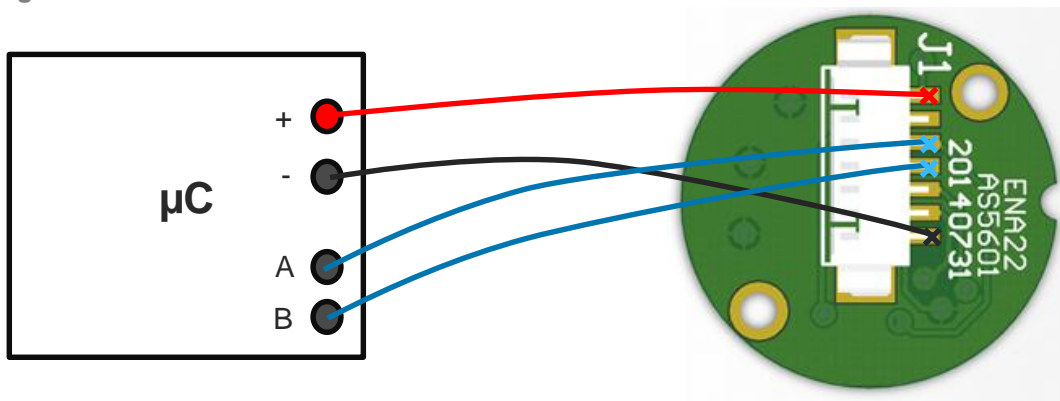

### 2.4.2 Pushbutton Detection

In this mode, the power supply and the pin Push of the reference module are connected. Over the programming interface the pushbutton detection can be adjusted.

Figure 5:  
Using the board in push button mode

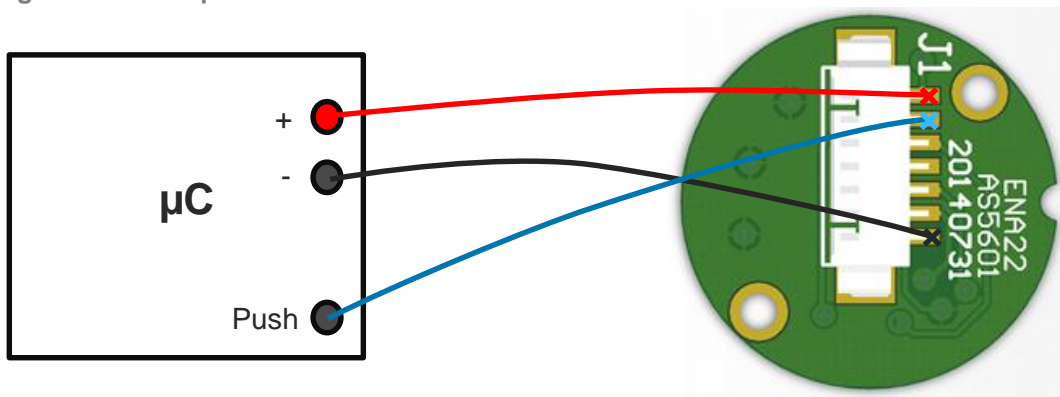

### 2.4.3 I<sup>2</sup>C Mode

Using the I<sup>2</sup>C Interface, all functions of the AS5601 can be configured and permanently programmed. Additionally the output and a raw angle (unmodified value) can be read from the output registers.

Figure 6:  
Using the reference module in I<sup>2</sup>C Mode

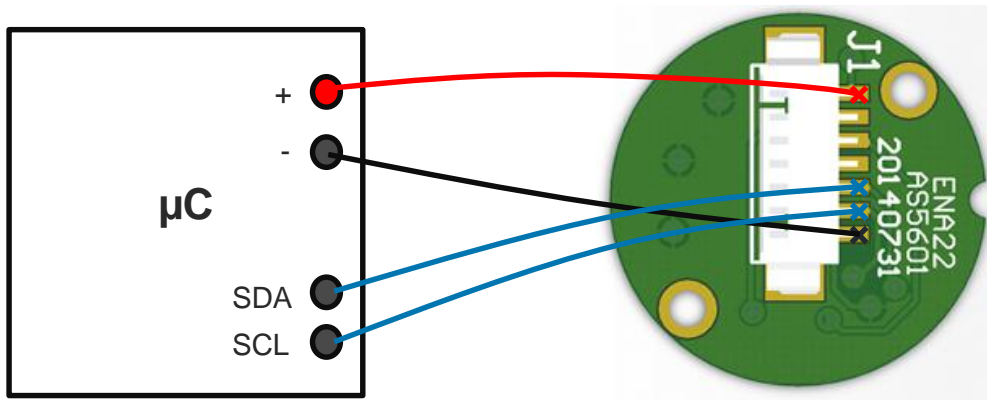

## 3 AS5601 Configuration

All options to configure the AS5601 are shown below. The AS5601 operates with a default configuration if no configuration was programmed.

### 3.1 Programming the output range

To adjust a custom angle to the full output range or to modify the Zero Position of the device, the AS5601 must be programmed. Following options are available:

- Programming start and stop position with I<sup>2</sup>C (Option A)
- Programming an angular excursion with I<sup>2</sup>C (Option B)

Follow the step-by-step instructions in the AS5601 datasheet for one of the above programming options.

### 3.2 Programming a configuration

A configuration must be written using the I<sup>2</sup>C interface. The Burn Setting command (Write 0x40 into register 0xFF) can be used to permanently program a configuration.

### 3.2.1 Low Power Mode

Three low power modes are available to reduce the power consumption down to 1,5mA max.

### 3.2.2 Hysteresis

A 1 to 3 LSB hysteresis of the 12-bit resolution can be enabled.

### 3.2.3 Output selection

Per default, the Analog Output is active if a magnet is present. Additionally the Output Pin can be switched to PWM with the option to select a PWM frequency (115Hz,230Hz,460Hz,920Hz)

### 3.2.4 Slow Filter

The slow filter allows improving the output noise. The default setting for the Slow Filter is 16x and can be reduced for faster response.

### 3.2.5 Fast Filter

The fast filter is active by selecting a Fast Filter Threshold. If the output value remains below the threshold, the output noise is defined by the slow filter setting. When exceeding the threshold, the output noise is defined from the fast filter for fast output response. The output noise is again defined by the slow filter as soon as the output stays in the threshold again.

### 3.2.6 Watchdog

If the watchdog is active, the AS5601 automatically enters Low Power Mode 3 after one minute if the output value stays within a threshold of 4 LSB.

## 4 Board Schematics, Layout and BOM

The schematic, layout and BOM of the adapter board are shown below for reference.

### 4.1 Schematics

The schematic of the board is shown below in Figure 7.

Figure 7:  
Reference Module PCB Schematic



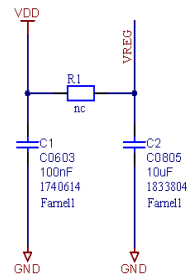
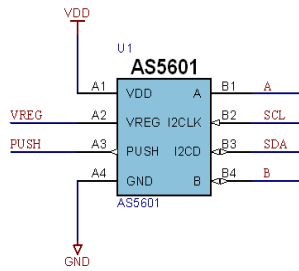
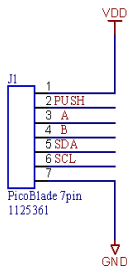

**Note2:** External Pull-ups required on I2C Bus  
**Note3:** AS5601 I2C Address is 0x36h

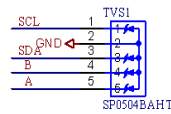
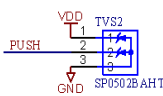

## 4.2 Layout and Board Dimensions

The PCB layout is shown below in Figure 8.

Figure 8:  
Reference Module PCB layout

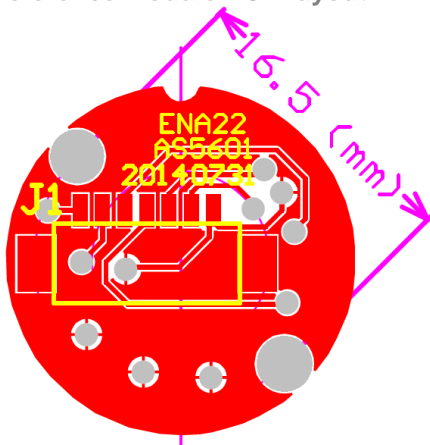

## 4.3 Bill of Materials

The BOM of the pcb is below in Table 3.

Table 3:  
Bill of Materials

Designator	Part	Footprint	Manufacturer	Comment
J1	Picoblade 7 Pin	Picoblade 7 Pin		
R1	Resistor / not populated	R0603		
C1	C0603	0603		
C2	C0805	0805		
TVS1	SP0504BAHT	SP0504BAHT-SOT23		

Designator	Part	Footprint	Manufacturer	Comment
TVS2	SP0502BAHT	SP0502BAHT-SOT23		
U1	AS5601	SOIC-8	amsAB	Smart Potentiometer IC

## 5 Evaluation tools

To configure the AS5601, no dedicated programmer is needed. For fast setup time the USB I&P Box can be used to configure the AS5601 over I<sup>2</sup>C. The USB I&P Box can be ordered from the ams webpage.

Please find the ordering information below in Table 4.

Table 4:

Ordering Information for Evaluation Tools

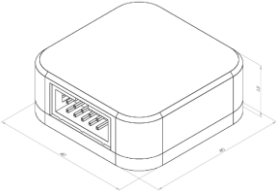
Ordering Code	Description	Image
USB I&P Box	To configure the AS5601	

## 6 Ordering Information

Please find the ordering information below in Table 5.

Table 5:

Ordering Information

Ordering Code	Description	Comments
AS5601-SO_RD_ST	AS5601 Reference Module	For rapid evaluation and prototyping

Get additional support material online at <http://www.ams.com/AS5601>.

## Copyright

Copyright ams AG, Tobelbader Strasse 30, 8141 Unterpremstätten, Austria-Europe. Trademarks Registered. All rights reserved. The material herein may not be reproduced, adapted, merged, translated, stored, or used without the prior written consent of the copyright owner.

## Disclaimer

Devices sold by ams AG are covered by the warranty and patent indemnification provisions appearing in its Term of Sale. ams AG makes no warranty, express, statutory, implied, or by description regarding the information set forth herein. ams AG reserves the right to change specifications and prices at any time and without notice. Therefore, prior to designing this product into a system, it is necessary to check with ams AG for current information. This product is intended for use in commercial applications. Applications requiring extended temperature range, unusual environmental requirements, or high reliability applications, such as military, medical life-support or life-sustaining equipment are specifically not recommended without additional processing by ams AG for each application. This Product is provided by ams "AS IS" and any express or implied warranties, including, but not limited to the implied warranties of merchantability and fitness for a particular purpose are disclaimed.

ams AG shall not be liable to recipient or any third party for any damages, including but not limited to personal injury, property damage, loss of profits, loss of use, interruption of business or indirect, special, incidental or consequential damages, of any kind, in connection with or arising out of the furnishing, performance or use of the technical data herein. No obligation or liability to recipient or any third party shall arise or flow out of ams AG rendering of technical or other services.

## Contact Information

### Headquarters

ams AG  
Tobelbader Strasse 30  
8141 Unterpremstaetten  
Austria  
T. +43 (0) 3136 500 0  
For Sales Offices, Distributors and Representatives, please visit:  
<http://www.ams.com/contact>