

SECTION A-A
(WITHOUT CAP)

SECTION A-A
(WITH CAP)

NOTES:

- MATERIAL:
HOUSING: NYLON, GLASS FILLED, UL94 V-0,
COLOR - SEE TABLE.
CAP: NYLON, GLASS FILLED, UL94V-0
COLOR: BEIGE.
PINS: BRASS ALLOY, C26000, P/N87437-8083.
- PLATING: 2.54µM. MIN. TIN OVER 1.27µM MIN. NICKEL.
- DRAWING SHOWS PLUG WITH 5 CIRCUITS.
- HEADER TO BE USED WITH CRIMP HOUSING, P/N 87439
AND CRIMP TERMINAL, P/N 87421.
- PARTS TO BE PACKED IN MOISTURE BAG.

ADD MOIST BAG NOTE EC NO: S2007-1049 DRWNS:KANG CHKD:ATSEE APPR:MLONG	2007/06/22	QUALITY SYMBOLS ▽=0 ▽C=0	DESCRIPTION REV
	2007/06/22		
	2007/06/22		
	2007/06/22		
D7			

GENERAL TOLERANCES (UNLESS SPECIFIED)	
mm	INCH
4 PLACES ± ---	± ---
3 PLACES ± ---	± ---
2 PLACES ± 0.20	± ---
1 PLACE ± ---	± ---
ANGULAR ± 3°	
DRAFT WHERE APPLICABLE MUST REMAIN WITHIN DIMENSIONS	

DIMENSION STYLE MM ONLY	
DRAWN BY KCLING	DATE 1994/04/08
CHECKED BY SKTOH	DATE 1994/04/21
APPROVED BY RWONG	DATE 1994/04/21
MATERIAL NO.	
SEE TABLE	
SIZE A3	THIS DRAWING CONTAINS INFORMATION THAT IS PROPRIETARY TO MOLEX INCORPORATED AND SHOULD NOT BE USED WITHOUT WRITTEN PERMISSION

SCALE NTS	DESIGN UNITS METRIC	THIRD ANGLE PROJECTION
TITLE 1.50MM PITCH, W-T-B HEADER, VERTICAL, SMT		
MOLEX INCORPORATED		
DOCUMENT NO. SD-87437-***31	SHEET NO. 1 OF 4	

10 9 8 7 6 5 4 3 2 1



PART NUMBER ASSIGNMENT

87437-XXXX

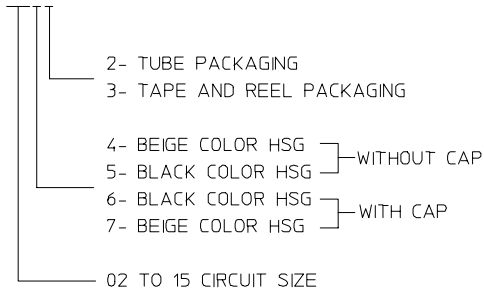

CIRCUIT SIZE	A	B	C	D	E
02	1.50	3.30	3.70	4.30	1.70
03	3.00	4.80	5.20	5.80	3.20
04	4.50	6.30	6.70	7.30	4.70
05	6.00	7.80	8.20	8.80	6.20
06	7.50	9.30	9.70	10.30	7.70
07	9.00	10.80	11.20	11.80	9.20
08	10.50	12.30	12.70	13.30	10.70
09	12.00	13.80	14.20	14.80	12.20
10	13.50	15.30	15.70	16.30	13.70
11	15.00	16.80	17.20	17.80	15.20
12	16.50	18.30	18.70	19.30	16.70
13	18.00	19.80	20.20	20.80	18.20
14	19.50	21.30	21.70	22.30	19.70
15	21.00	22.80	23.20	23.80	21.20

F

E

D

C

B

A

F

E

D

C

B

A

ADD MOIST BAG NOTE EC NO: S2007-1049 DRWN:SKANG CHKD:ATSEE APPR:MLONG	2007/06/22 2007/06/22 2007/06/22	QUALITY SYMBOLS ▽=0 ▽=0	GENERAL TOLERANCES (UNLESS SPECIFIED)		DIMENSION STYLE MM ONLY		SCALE NTS	DESIGN UNITS METRIC	THIRD ANGLE PROJECTION			
			4 PLACES ± --- ± ---	3 PLACES ± --- ± ---	DRAWN BY KCLING	DATE 1994/04/08	TITLE 1.50MM PITCH, W-T-B HEADER, VERTICAL, SMT					
			2 PLACES ± 0.20 ± ---	1 PLACE ± --- ± ---	CHECKED BY SKTOH	DATE 1994/04/21						
			ANGULAR ± 3 °		APPROVED BY RWONG		DATE 1994/04/21	MOLEX INCORPORATED				
		DRAFT WHERE APPLICABLE MUST REMAIN WITHIN DIMENSIONS		MATERIAL NO. SEE TABLE		DOCUMENT NO. SD-87437-**31	SHEET NO. 2 OF 4					

9 8 7 6 5 4 3 2 1

10 9 8 7 6 5 4 3 2 1

EMBOSSED CARRIER TAPE PACKING DETAILS FOR PARTS WITHOUT CAP

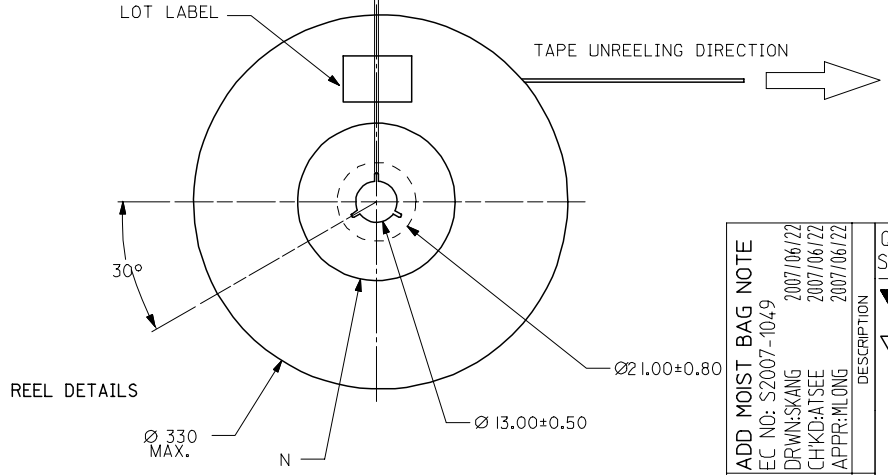
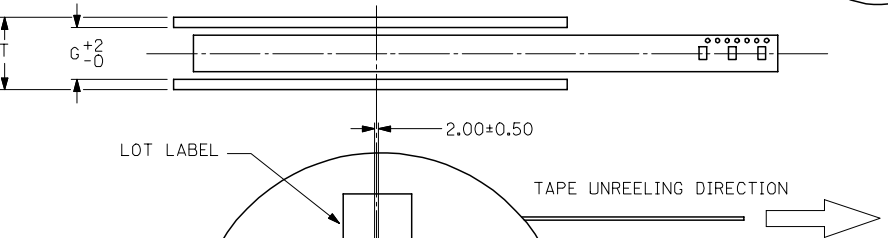
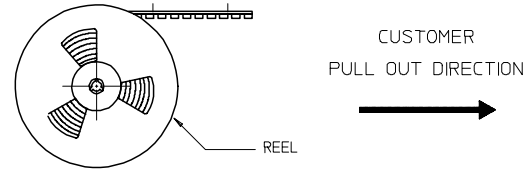
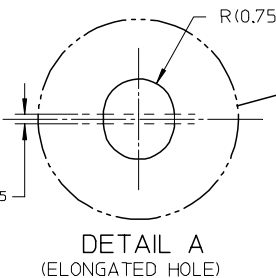

ADD MOIST BAG NOTE	DESCRIPTION
EC NO: S2007-1049	DRWNS:SKANG
2007/06/22	CHKD:ATSEE
2007/06/22	APPR:MLONG
2007/06/22	
D7	REV

QUALITY SYMBOLS	$\nabla=0$
	$\sphericalangle=0$

GENERAL TOLERANCES (UNLESS SPECIFIED)	DIMENSION STYLE	
	MM ONLY	
	mm	INCH
4 PLACES	\pm ---	\pm ---
3 PLACES	\pm ---	\pm ---
2 PLACES	± 0.20	\pm ---
1 PLACE	\pm ---	\pm ---
	ANGULAR $\pm 3^\circ$	
DRAFT WHERE APPLICABLE MUST REMAIN WITHIN DIMENSIONS		

DRAWN BY	DATE	TITLE
KCLING	1994/04/08	1.50MM PITCH, W-T-B HEADER, VERTICAL, SMT
CHECKED BY	DATE	
SKTOH	1994/04/21	
APPROVED BY	DATE	
RWONG	1994/04/21	
MATERIAL NO.	DOCUMENT NO.	SHEET NO.
SEE TABLE	SD-87437-**-31	3 OF 4
THIS DRAWING CONTAINS INFORMATION THAT IS PROPRIETARY TO MOLEX INCORPORATED AND SHOULD NOT BE USED WITHOUT WRITTEN PERMISSION		

SCALE	DESIGN UNITS	THIRD ANGLE PROJECTION
NTS	METRIC	
MOLEX INCORPORATED		
SD-87437-**-31		
3 OF 4		

9 8 7 6 5 4 3 2 1

EMBOSSED CARRIER TAPE PACKING DETAILS FOR PARTS WITH CAP

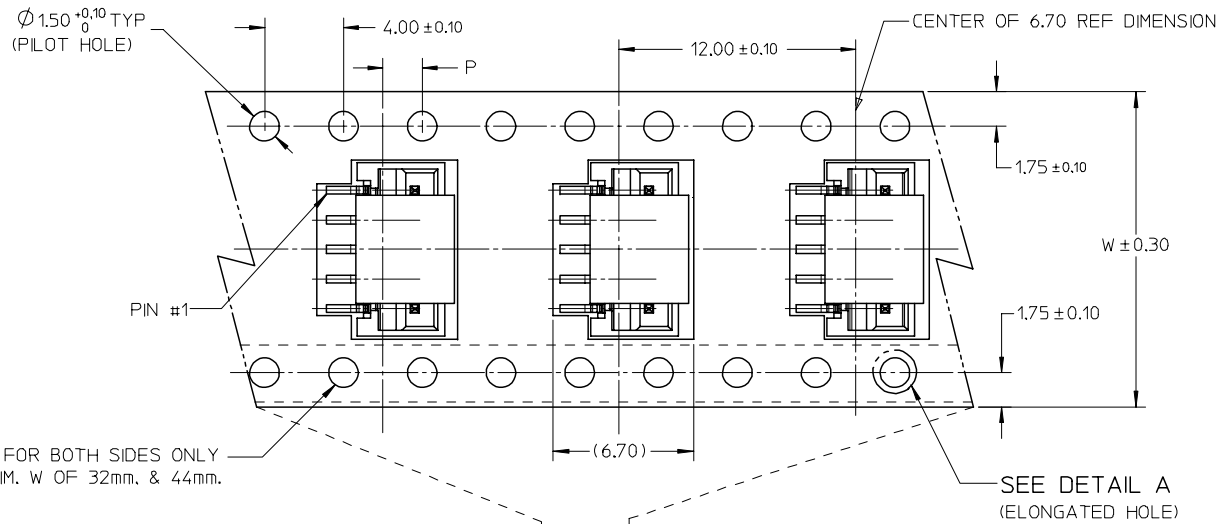

NOTES:

1. LEADER AND TRAILER TAPE

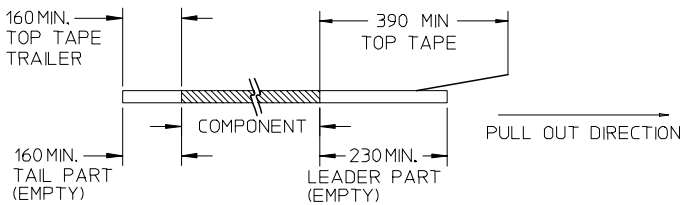

2. PEELING OFF FORCE OF THE TOP TAPE: 20-80gf.
(PEELING DIRECTION AS SHOWN IN FOLLOWING FIGURE)

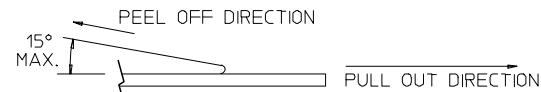

3. THE TAPE IS TREATED FOR ANTI-STATIC.
4. PACKAGING STANDARD IS AS PER EIA-481.
5. TAPE & REEL QUANTITY = 1000PCS/REEL (WITHOUT CAP)
TAPE & REEL QUANTITY = 900PCS/REEL (WITH CAP)

15	44	20.20±0.15	100	44.40	50.40	2.00±0.15
11, 12, 13, 14	32	14.20±0.10	100	32.40	38.40	2.00±0.10
7, 8, 9, 10	24	11.50±0.10	100	24.40	30.40	2.00±0.10
2, 3, 4, 5, 6	16	7.50±0.10	100	16.40	22.40	2.00±0.10
CIRCUIT SIZE	W	F	N	G	T MAX	P

ADD MOIST BAG NOTE EC NO: S2007-1049 DRWNS:KANG CHKD:ATSEE APPR:MLONG	2007/06/22 2007/06/22 2007/06/22	QUALITY SYMBOLS ▽=0 ▽=0	GENERAL TOLERANCES (UNLESS SPECIFIED)		DIMENSION STYLE MM ONLY		SCALE NTS	DESIGN UNITS METRIC	THIRD ANGLE PROJECTION	
					DRAWN BY KCLING		DATE 1994/04/08	TITLE 1.50MM PITCH, W-T-B HEADER, VERTICAL, SMT		
			4 PLACES ± --- ± ---		CHECKED BY		DATE 1994/04/21	APPROVED BY RWONG		
			3 PLACES ± --- ± ---		APPROVED BY RWONG		DATE 1994/04/21	MATERIAL NO. SD-87437-**-31		
2 PLACES ± 0.20 ± ---		DRAFT WHERE APPLICABLE MUST REMAIN WITHIN DIMENSIONS		SEE TABLE		DOCUMENT NO. SD-87437-**-31		SHEET NO. 4 OF 4		
1 PLACE ± --- ± ---		ANGULAR ± 3 °		SIZE A3		THIS DRAWING CONTAINS INFORMATION THAT IS PROPRIETARY TO MOLEX INCORPORATED AND SHOULD NOT BE USED WITHOUT WRITTEN PERMISSION				