

## DESCRIPTION

Demonstration circuit DC2247A is a 36V 2A synchronous 2MHz boost LED driver featuring the [LT<sup>®</sup>3922](#). It drives a single string of LEDs at 330mA up to 34V when  $V_{IN}$  is between 7V and 28V. It runs down to  $4V_{IN}$  with reduced  $I_{LED}$  and can withstand  $V_{IN}$  as high as 36V, but has overvoltage lockout (OVLO) set for 28V for this application. DC2247A runs at 2MHz switching frequency. Spread spectrum frequency modulation (SSFM) can be turned on with a simple jumper, reducing EMI. DC2247A comes with low EMI features including optimized layout, SSFM, and input and output filters. It passes CISPR 25 class 5 conducted and radiated EMI. It is protected against both open and short LED conditions and reports the faults.

The LT3922 has an input voltage range from 2.8V to 36V. Its internal synchronous 2A 40V switches allow up to 34V of LEDs on the output with room for overvoltage protection and overshoot during an open LED event. It has adjustable switching frequency between 200kHz and 2.5MHz. It can be synchronized to an external source or programmed with SSFM for low EMI. The PWM TG high side PWM MOSFET driver assists with short-circuit protection and versatility. LT3922 can be configured as boost, boost-buck, or buck mode LED driver and maintain all of its low-EMI, PWM dimming and fault diagnostic features.

The LT3922 can be PWM dimmed with an external PWM signal or an internally-generated PWM signal. DC2247A has a jumper that can be set to switch between internally-generated PWM signal, externally-generated PWM signal, and no PWM signal (100% on). It can be analog dimmed with a control voltage on its CTRL pin.

When run with both PWM dimming and SSFM, the spread spectrum aligns itself with the PWM signal for flicker-free operation.

Small ceramic input and output capacitors are used to save space and cost. The board is designed with tiny, high frequency capacitors on both sides of the  $V_{OUT}$  pins for a reduction in radiated EMI. The open LED overvoltage protection uses the IC's constant voltage regulation loop to regulate the output to approximately 37.5V if the LED string is opened although it may reach almost 40V peak during transient from running LEDs to open. There is a protection diode from LED<sup>+</sup> to GND to prevent negative ringing during a short circuit. The output current can be monitored through the ISMON output pin.

Undervoltage and overvoltage lockout can be adjusted on the circuit with a few simple resistor choices.

There is an EMI filter on the input of DC2247A. There is also a small ferrite bead output filter. These filters, combined with proper board layout and SSFM are effective to help the PCB pass CISPR 25 class 5 conducted and radiated EMI. Please follow the recommended layout and four-layer thickness of DC2247A for low EMI applications.

The LT3922 data sheet gives a complete description of the part, operation and applications information. The data sheet must be read in conjunction with this Demo Manual for DC2247A. The LT3922EUF is assembled in a 28-lead plastic 4mm x 5mm QFN package with a thermally enhanced ground pad. Proper board layout is essential for maximum thermal performance. See the data sheet section Layout Considerations.

**Design files for this circuit board are available at <http://www.linear.com/demo/DC2247A>**

 , LT, LTC, LTM, Linear Technology and the Linear logo are registered trademarks of Linear Technology Corporation. All other trademarks are the property of their respective owners.

# DEMO MANUAL DC2247A

## PERFORMANCE SUMMARY Specifications are at $T_A = 25^\circ\text{C}$

PARAMETER	CONDITIONS	MIN	TYP	MAX	UNITS
Input Voltage Low EMI $V_{IN}$ Range	Operating $I_{LED} > 0\text{mA}$	4		28	V
Input Voltage Low EMI $V_{IN}$ Range	Operating $V_{LED} = 34\text{V}$ , $I_{LED} = 330\text{mA}$	7		28	V
Safe Input Voltage Low EMI $V_{IN}$ Range		0		36	V
Switching Frequency	$R2 = 45.3\text{k}$ , SSFM = OFF		2		MHz
Switching Frequency	$R2 = 45.3\text{k}$ , SSFM = ON		2 to 2.5		MHz
$I_{LED}$	$R1 = 0.3\Omega$ , $7.0\text{V} < \text{Low EMI } V_{IN} < 28\text{V}$ , $V_{LED} = 34\text{V}$		330		mA
$V_{LED}$ Range	$R4 = 1\text{M}$ , $R5 = 33.2\text{k}$	$V_{IN}$		34	V
Open LED Voltage $V_{OUT}$	$R4 = 1\text{M}$ , $R5 = 33.2\text{k}$ , OPEN LOAD		37.5		V
Efficiency (100% PWM DC)	$PV_{IN} = 12\text{V}$ , $V_{LED} = 34\text{V}$ , $I_{LED} = 330\text{mA}$		90		%
Efficiency with EMI Filters Removed	$PV_{IN} = 12\text{V}$ , $V_{LED} = 34\text{V}$ , $I_{LED} = 330\text{mA}$		91		%
Internally-Generated PWM Dimming Range	Operating JP1 = INT, JP2 = INT	1/128		100%	
Internally-Generated PWM Dimming Frequency	Operating JP1 = INT, JP2 = INT $R10 = 332\text{k}$		122		Hz

## QUICK START PROCEDURE

Demonstration circuit DC2247A is easy to set up to evaluate the performance of the LT3922. Follow the procedure below:

1. With power off, connect a string of LEDs that will run with forward voltage less than or equal to 34V (at 330mA) to the LED<sup>+</sup> and LED<sup>-</sup> terminals on the PCB as shown in Figure 1.
2. Connect the EN/UVLO terminal to GND.
3. Set JP1 to ON and JP2 to EXT/ON for 100% always-on LED operation. Set JP3 to NO SSFM to run without SSFM or external synchronization.
4. With power off, connect the input power supply to the LOW EMI VIN and GND terminals. Make sure that the input voltage will not exceed 36V.
5. Turn the input power supply on and make sure the voltage is between 5V and 36V to start operation.
6. Release the EN/UVLO-to-GND connection.
7. Observe the LED string running at the programmed LED current.
8. To change the brightness with analog dimming, simply attach a voltage source to the CTRL terminal and set the voltage between 0V and 1.5V. See data sheet for details.
9. To change brightness with external PWM dimming, set JP1 to EXT and JP2 to EXT/ON. Attach a 3V rectangular waveform with varying duty cycle to the PWM terminal.
10. To change brightness with internally-generated PWM dimming, set JP1 to INT and JP2 to INT. Adjust the setting of the VR1 variable resistor with a small flat-head screwdriver to toggle between 0% and 100% PWM dimming duty cycle in 1/128 steps.
11. To enable spread spectrum frequency modulation, set JP3 to SSFM ON.

## QUICK START PROCEDURE

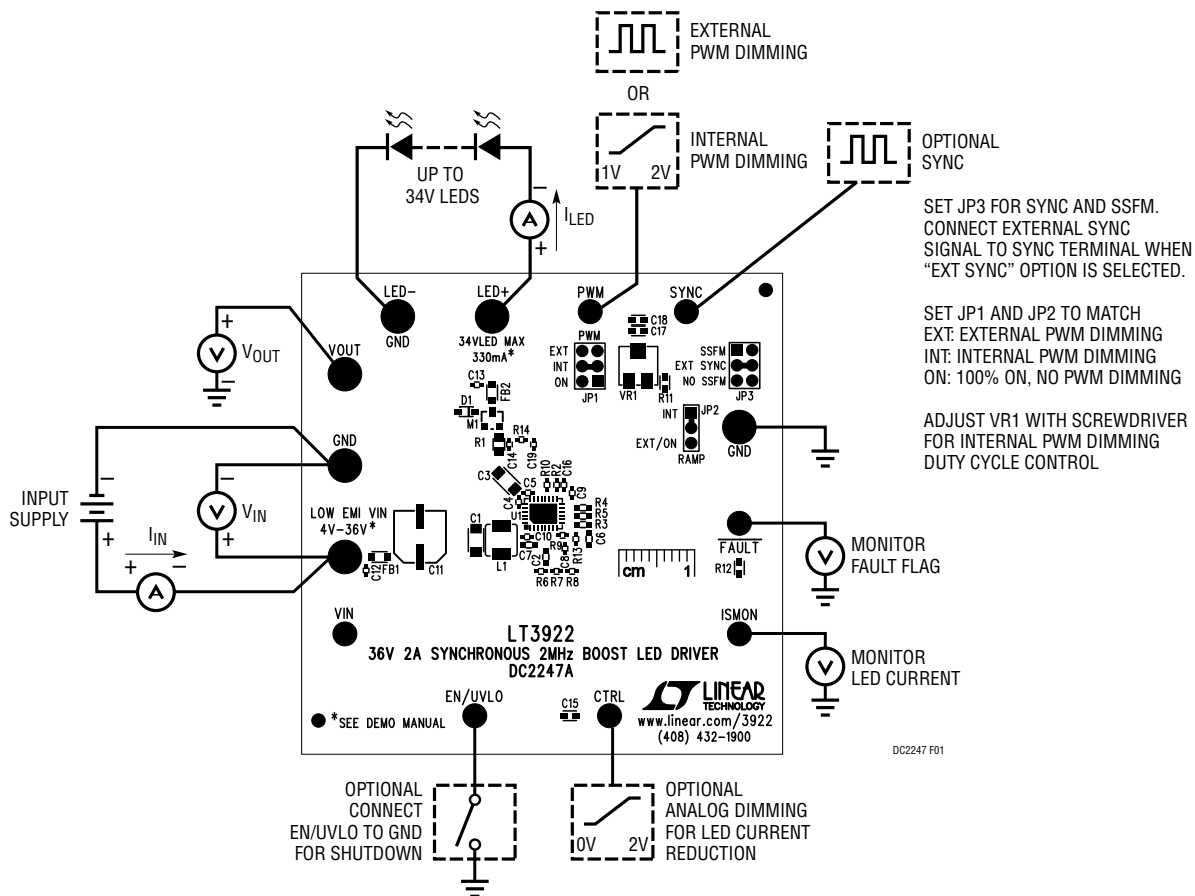
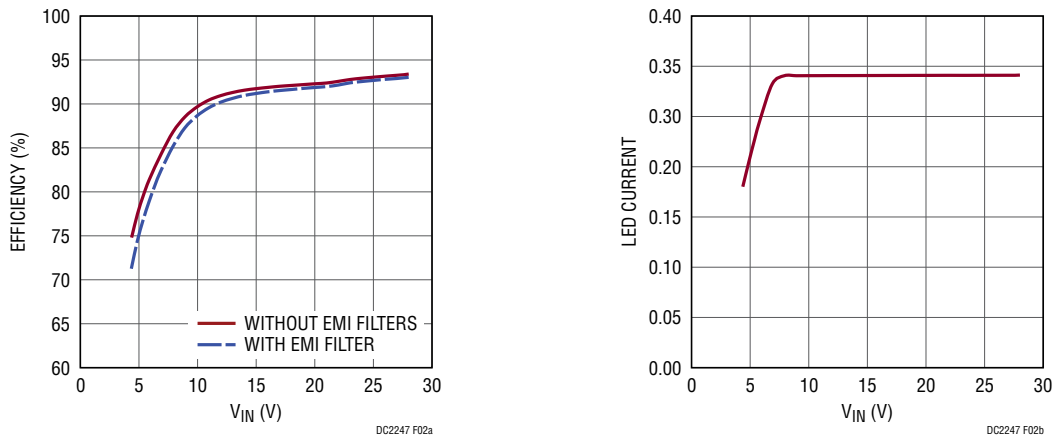
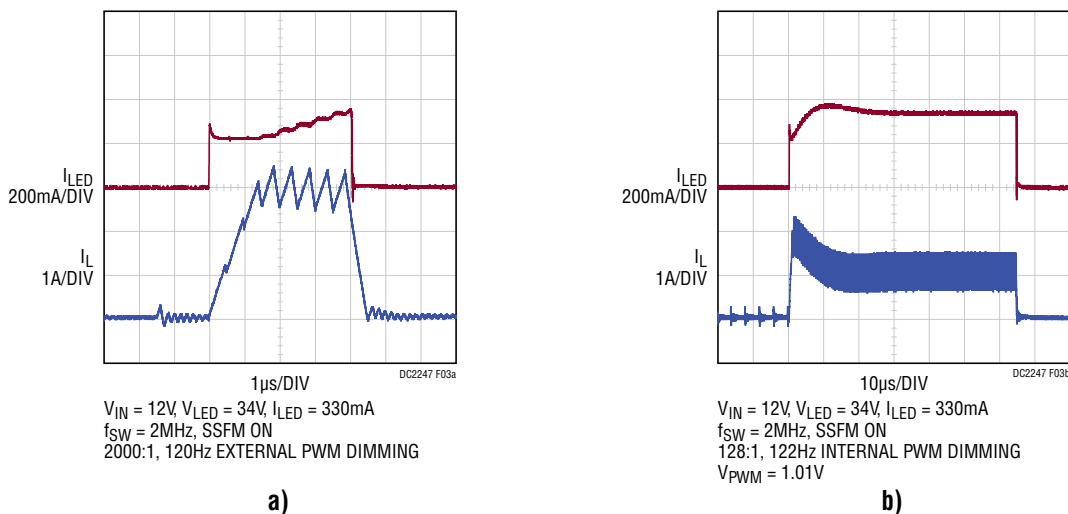

Figure 1. Test Procedure Setup Drawing for DC2247A

## QUICK START PROCEDURE

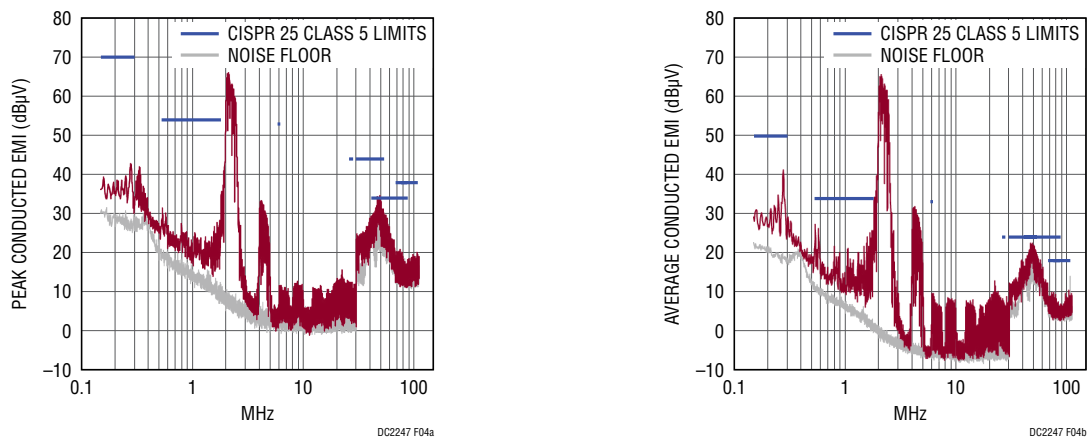

**Figure 2. DC2247A Efficiency and LED Current Versus Input Voltage for 34V 330mA LED Load. Efficiency Remains High Through the Range Due to Synchronous Switching. At Low VIN, ILED Can Be Reduced Due to Peak Switch Current Limit**

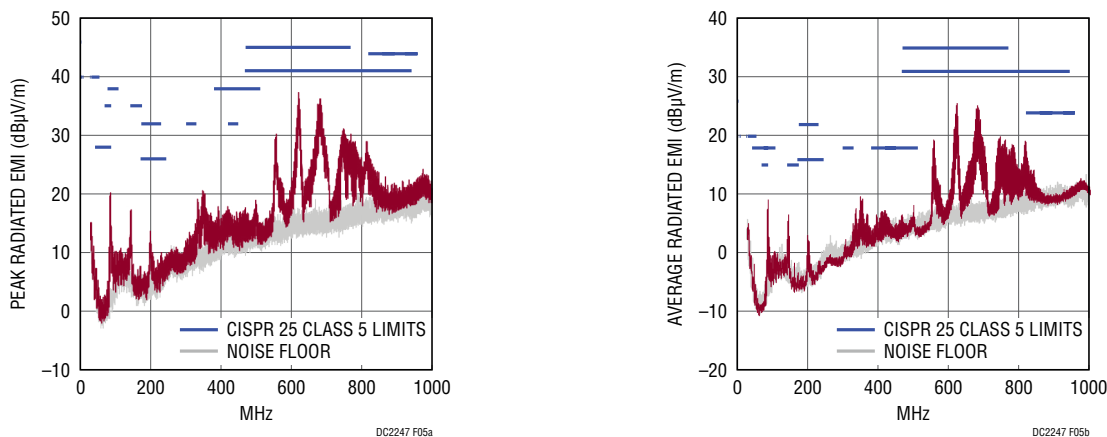

**Figure 3. Infinite-Persist Scope Traces Show PWM Dimming and SSFM Working Together for Flicker-Free Brightness Control with both a) Externally and b) Internally Generated PWM Dimming**

**QUICK START PROCEDURE**



**Figure 4. DC2247A Conducted Peak and Average EMI—Passes CISPR 25 Class 5 Limits.**



**Figure 5. DC2247A Radiated Peak and Average EMI—30MHz to 1GHz—Passes CISPR 25 Class 5 Limits**

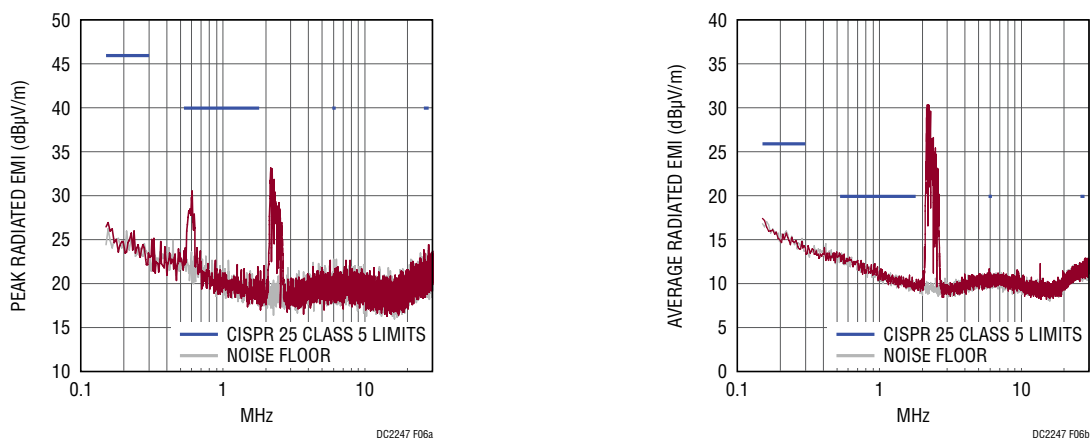

**Figure 6. DC2247A Radiated Peak and Average EMI—150kHz to 30MHz—Passes CISPR 25 Class 5 Limits**

# DEMO MANUAL DC2247A

## PARTS LIST

ITEM	QTY	REFERENCE	PART DESCRIPTION	MANUFACTURER/PART NUMBER
<b>Required Circuit Components</b>				
1	1	C1	CAP, X5R, 4.7 $\mu$ F, 50V, 10%, 1206	MURATA, GRM31CR71H475KA12L
2	1	C2	CAP, X5R, 1 $\mu$ F, 50V, 10%, 0603	TDK, C1608X5R1H105K080AB
3	1	C3	CAP, X7R, 2.2 $\mu$ F, 50V, 10%, 1206	MURATA, GRM31CR71H225KA88K
4	2	C4, C5	CAP, X5R, 0.47 $\mu$ F, 50V, 10%, 0402	TAIYO YUDEN, UMK105ABJ474KV-F
5	1	C6	CAP, X7R, 220pF, 50V, 10%, 0603	MURATA, GRM188R71H221KA01D
6	1	C7	CAP, X7R, 2.2 $\mu$ F, 6.3V 10%, 0603	AVX, 06036C225KAT2A
7	1	C8	CAP, X5R, 1 $\mu$ F, 6.3V, 10%, 0402	MURATA, GRM155R60J105KE19D
8	2	C9, C10	CAP, X7R, 100nF, 6.3V, 10%, 0402	AVX, 04026C104KAT2A
21	1	L1	INDUCTOR, 4.7 $\mu$ H, 4.45mm x 4.06mm	WURTH ELEKTRONIK, 74437324047
22	1	M1	P-MOSFET, Si2319CDS, SOT23	VISHAY, SI2319CDS-T1-GE3
23	1	R1	RES, CHIP, 0.3, 1/3W, 1%, 0805	SUSUMU, RL1220S-R30-F
24	1	R2	RES, CHIP, 45.3k, 1/16W, 1%, 0402	VISHAY, CRCW040245K3FKED
25	1	R3	RES, CHIP, 24k, 1/10W, 1%, 0603	VISHAY, CRCW060324K0FKEA
26	1	R4	RES, CHIP, 1M, 1/10W, 1%, 0603	VISHAY, CRCW06031M00FKEA
27	1	R5	RES, CHIP, 33.2k, 1/10W, 1%, 0603	VISHAY, CRCW060333K2FKEA
28	1	R6	RES, CHIP, 499k, 1/16W, 1%, 0402	VISHAY, CRCW0402499KFKED
29	1	R7	RES, CHIP, 221k, 1/16W, 1%, 0402	VISHAY, CRCW0402221KFKED
30	1	R8	RES, CHIP, 31.6k, 1/16W, 1%, 0402	VISHAY, CRCW040231K6FKED
31	1	R9	RES, CHIP, 100k, 1/16W, 1%, 0402	VISHAY, CRCW0402100KFKED
32	1	R10	RES, CHIP, 332k, 1/16W, 1%, 0402	VISHAY, CRCW0402332KFKED
36	1	U1	I.C., LED DRIVER, 28QFN 4X5	LINEAR TECH., LT3922EUFDP#PBF
<b>Optional Demo Board Circuit Components</b>				
9	1	C11	CAP, ALUM., 33 $\mu$ F, 50V, 20%, 6.3mm x 7.7mm	SUN ELECTRONIC INDUSTRIES CORPORATION, 50CE33BS
10	2	C12, C13	CAP, X7R, 0.1 $\mu$ F, 50V, 10%, 0402	MURATA, GRM155R71H104KE14D
11	1	C14	CAP, X5R, 2.2 $\mu$ F, 6.3V, 10%, 0402	MURATA, GRM155R60J225ME15D
12	0	C15, C17, C18 (OPT)	CAP, OPTION, 0603	
13	0	C16, C19 (OPT)	CAP, OPTION, 0402	
14	1	D1	DIODE, SCHOTTKY, 40V, 1A, SOD323F	NXP, PMEG4010CEJ, 115
17	1	FB1	CHIP, BEAD, 600 $\Omega$ , 0805	WURTH ELEKTRONIK, 742792040
18	1	FB2	CHIP, BEAD, 1.5k, 0805	WURTH ELEKTRONIK, 742792097
33	1	R11	RES, CHIP, 91k, 1/10W, 5%, 0603	VISHAY, CRCW060391K0JNEA
34	1	R12	RES, CHIP, 51k, 1/10W, 1%, 0603	VISHAY, CRCW060351K0FKEA
35	0	R13, R14 (OPT)	RES, OPTION, 0402	
37	1	VR1	TRIMMER., 100k, 0.25W, SMD	BOURNS, 3314J-1-104E
<b>Hardware: For Demo Board Only</b>				
15	6	E1, E3, E8, E11-E13	TEST POINT, TURRET, 0.094" MTG. HOLE	MILL-MAX, 2501-2-00-80-00-00-07-0
16	7	E2, E4-E7, E9, E10	TEST POINT, TURRET, 0.061" MTG. HOLE	MILL-MAX, 2308-2-00-80-00-00-07-0
19	2	JP1, JP3	HEADER 3 PIN 0.079 DOUBLE ROW	WURTH ELEKTRONIK, 62000621121
20	1	JP2	HEADER 3 PIN 0.079 SINGLE ROW	WURTH ELEKTRONIK, 62000311121
38	3	XJP1, XJP2, XJP3	SHUNT, 0.079" CENTER	WURTH ELEKTRONIK, 60800213421

## SCHEMATIC DIAGRAM

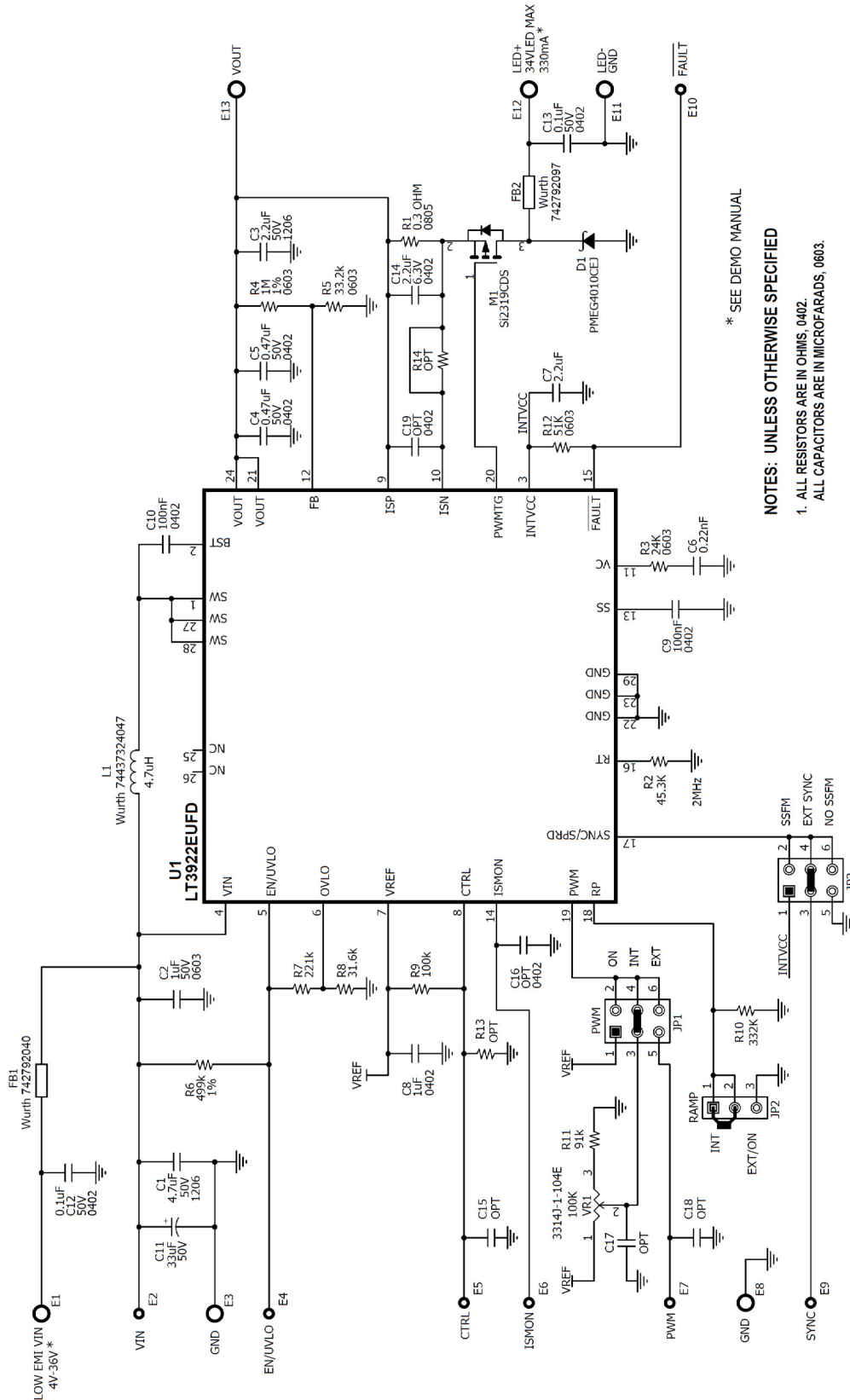

\* SEE DEMO MANUAL

**NOTES: UNLESS OTHERWISE SPECIFIED**

1. ALL RESISTORS ARE IN OHMS, 0402.
- ALL CAPACITORS ARE IN MICROFARADS, 0603.

# DEMO MANUAL DC2247A

---

## DEMONSTRATION BOARD IMPORTANT NOTICE

Linear Technology Corporation (LTC) provides the enclosed product(s) under the following **AS IS** conditions:

This demonstration board (DEMO BOARD) kit being sold or provided by Linear Technology is intended for use for **ENGINEERING DEVELOPMENT OR EVALUATION PURPOSES ONLY** and is not provided by LTC for commercial use. As such, the DEMO BOARD herein may not be complete in terms of required design-, marketing-, and/or manufacturing-related protective considerations, including but not limited to product safety measures typically found in finished commercial goods. As a prototype, this product does not fall within the scope of the European Union directive on electromagnetic compatibility and therefore may or may not meet the technical requirements of the directive, or other regulations.

If this evaluation kit does not meet the specifications recited in the DEMO BOARD manual the kit may be returned within 30 days from the date of delivery for a full refund. **THE FOREGOING WARRANTY IS THE EXCLUSIVE WARRANTY MADE BY THE SELLER TO BUYER AND IS IN LIEU OF ALL OTHER WARRANTIES, EXPRESSED, IMPLIED, OR STATUTORY, INCLUDING ANY WARRANTY OF MERCHANTABILITY OR FITNESS FOR ANY PARTICULAR PURPOSE. EXCEPT TO THE EXTENT OF THIS INDEMNITY, NEITHER PARTY SHALL BE LIABLE TO THE OTHER FOR ANY INDIRECT, SPECIAL, INCIDENTAL, OR CONSEQUENTIAL DAMAGES.**

The user assumes all responsibility and liability for proper and safe handling of the goods. Further, the user releases LTC from all claims arising from the handling or use of the goods. Due to the open construction of the product, it is the user's responsibility to take any and all appropriate precautions with regard to electrostatic discharge. Also be aware that the products herein may not be regulatory compliant or agency certified (FCC, UL, CE, etc.).

No License is granted under any patent right or other intellectual property whatsoever. **LTC assumes no liability for applications assistance, customer product design, software performance, or infringement of patents or any other intellectual property rights of any kind.**

LTC currently services a variety of customers for products around the world, and therefore this transaction **is not exclusive**.

**Please read the DEMO BOARD manual prior to handling the product.** Persons handling this product must have electronics training and observe good laboratory practice standards. **Common sense is encouraged.**

This notice contains important safety information about temperatures and voltages. For further safety concerns, please contact a LTC application engineer.

Mailing Address:

Linear Technology  
1630 McCarthy Blvd.  
Milpitas, CA 95035

Copyright © 2004, Linear Technology Corporation