

Standard Rectifier Module

3~ Rectifier	
V_{RRM}	= 1800
I_{DAV}	= 80
I_{FSM}	= 600

3~ Rectifier Bridge

Part number

VUO80-18NO1

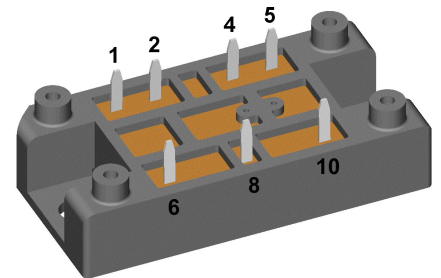

Backside: isolated

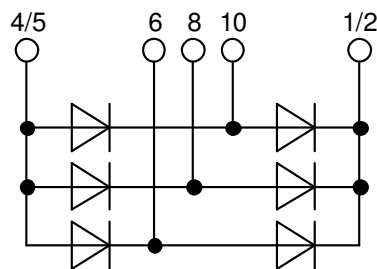

Features / Advantages:

- Package with DCB ceramic
- Improved temperature and power cycling
- Planar passivated chips
- Very low forward voltage drop
- Very low leakage current

Applications:

- Diode for main rectification
- For three phase bridge configurations
- Supplies for DC power equipment
- Input rectifiers for PWM inverter
- Battery DC power supplies
- Field supply for DC motors

Package: V1-A-Pack

- Isolation Voltage: 3600 V~
- Industry standard outline
- RoHS compliant
- Soldering pins for PCB mounting
- Height: 17 mm
- Base plate: DCB ceramic
- Reduced weight
- Advanced power cycling

Terms Conditions of usage:

The data contained in this product data sheet is exclusively intended for technically trained staff. The user will have to evaluate the suitability of the product for the intended application and the completeness of the product data with respect to his application. The specifications of our components may not be considered as an assurance of component characteristics. The information in the valid application- and assembly notes must be considered. Should you require product information in excess of the data given in this product data sheet or which concerns the specific application of your product, please contact the sales office, which is responsible for you.

Due to technical requirements our product may contain dangerous substances. For information on the types in question please contact the sales office, which is responsible for you.

Should you intend to use the product in aviation, in health or live endangering or life support applications, please notify. For any such application we urgently recommend

- to perform joint risk and quality assessments;

- the conclusion of quality agreements;

- to establish joint measures of an ongoing product survey, and that we may make delivery dependent on the realization of any such measures.

Rectifier				Ratings			
Symbol	Definition	Conditions		min.	typ.	max.	Unit
V_{RSM}	max. non-repetitive reverse blocking voltage			$T_{VJ} = 25^{\circ}C$		1900	V
V_{RRM}	max. repetitive reverse blocking voltage			$T_{VJ} = 25^{\circ}C$		1800	V
I_R	reverse current	$V_R = 1800$ V		$T_{VJ} = 25^{\circ}C$		40	μA
		$V_R = 1800$ V		$T_{VJ} = 150^{\circ}C$		1,5	mA
V_F	forward voltage drop	$I_F = 30$ A		$T_{VJ} = 25^{\circ}C$		1,14	V
		$I_F = 90$ A				1,48	V
		$I_F = 30$ A		$T_{VJ} = 125^{\circ}C$		1,06	V
		$I_F = 90$ A				1,51	V
I_{DAV}	bridge output current	$T_C = 110^{\circ}C$		$T_{VJ} = 150^{\circ}C$		80	A
		rectangular	$d = \frac{1}{3}$				
V_{FO}	threshold voltage			$T_{VJ} = 150^{\circ}C$		0,81	V
r_F	slope resistance					7,8	m Ω
						} for power loss calculation only	
R_{thJC}	thermal resistance junction to case					1,1	K/W
R_{thCH}	thermal resistance case to heatsink				0,3		K/W
P_{tot}	total power dissipation			$T_C = 25^{\circ}C$		110	W
I_{FSM}	max. forward surge current	$t = 10$ ms; (50 Hz), sine		$T_{VJ} = 45^{\circ}C$		600	A
		$t = 8,3$ ms; (60 Hz), sine		$V_R = 0$ V		650	A
		$t = 10$ ms; (50 Hz), sine		$T_{VJ} = 150^{\circ}C$		510	A
		$t = 8,3$ ms; (60 Hz), sine		$V_R = 0$ V		550	A
I^2t	value for fusing	$t = 10$ ms; (50 Hz), sine		$T_{VJ} = 45^{\circ}C$		1,80	kA ² s
		$t = 8,3$ ms; (60 Hz), sine		$V_R = 0$ V		1,76	kA ² s
		$t = 10$ ms; (50 Hz), sine		$T_{VJ} = 150^{\circ}C$		1,30	kA ² s
		$t = 8,3$ ms; (60 Hz), sine		$V_R = 0$ V		1,26	kA ² s
C_J	junction capacitance	$V_R = 400$ V; $f = 1$ MHz		$T_{VJ} = 25^{\circ}C$		18	pF

Package V1-A-Pack				Ratings		
Symbol	Definition	Conditions	min.	typ.	max.	Unit
I_{RMS}	RMS current	per terminal			100	A
T_{VJ}	virtual junction temperature		-40		150	°C
T_{op}	operation temperature		-40		125	°C
T_{stg}	storage temperature		-40		125	°C
Weight				37		g
M_D	mounting torque		2		2,5	Nm
$d_{Spp/App}$	creepage distance on surface / striking distance through air	terminal to terminal	6,0			mm
$d_{Spb/Apb}$		terminal to backside	12,0			mm
V_{ISOL}	isolation voltage	t = 1 second	3600			V
		t = 1 minute	3000			V

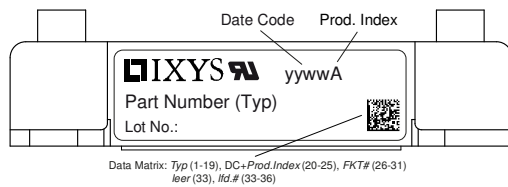

Ordering	Ordering Number	Marking on Product	Delivery Mode	Quantity	Code No.
Standard	VUO80-18NO1	VUO80-18NO1	Blister	24	469181

Equivalent Circuits for Simulation			* on die level	$T_{VJ} = 150\text{ °C}$
	Rectifier			
$V_{0\ max}$	threshold voltage	0,81		V
$R_{0\ max}$	slope resistance *	6,6		mΩ

Outlines V1-A-Pack

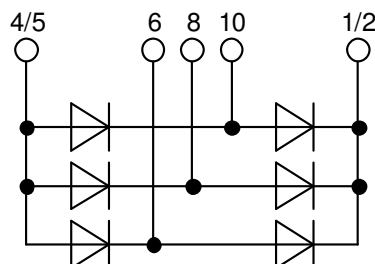
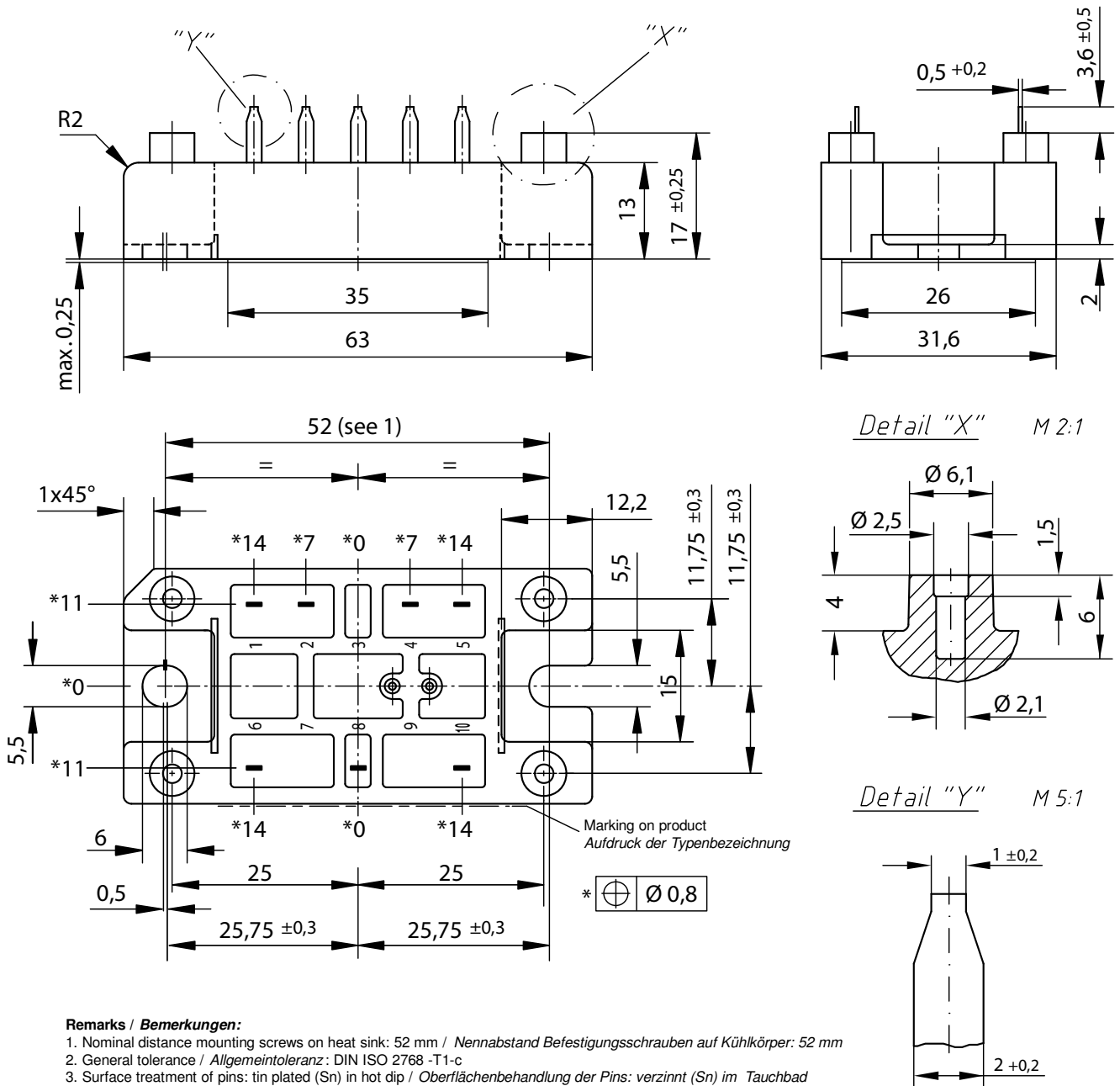

Rectifier

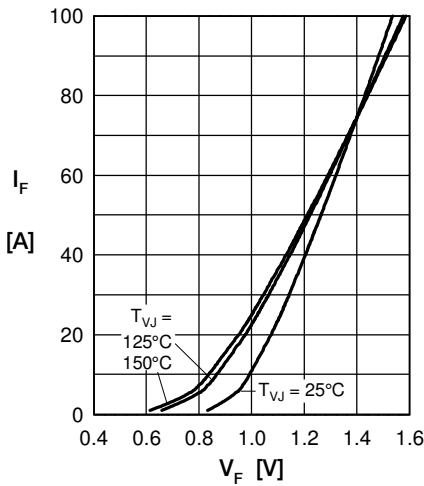

Fig. 1 Forward current vs. voltage drop per diode

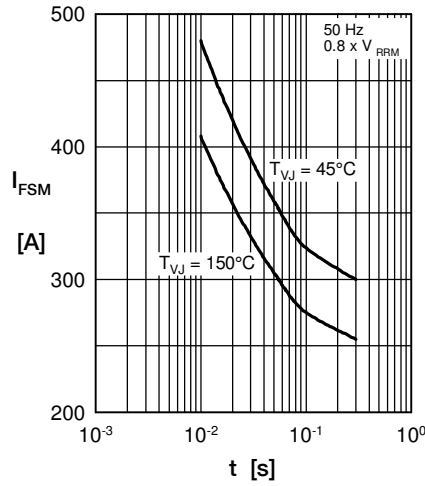

Fig. 2 Surge overload current vs. time per diode

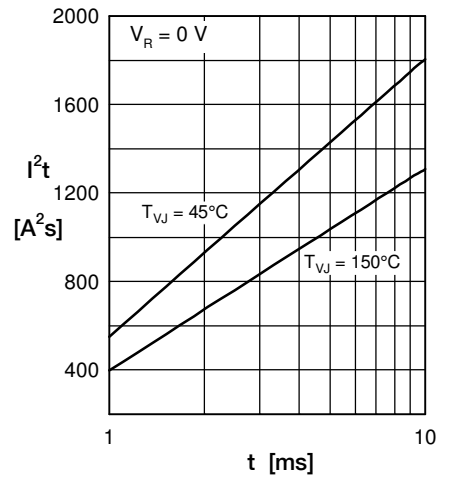

Fig. 3 I²t vs. time per diode

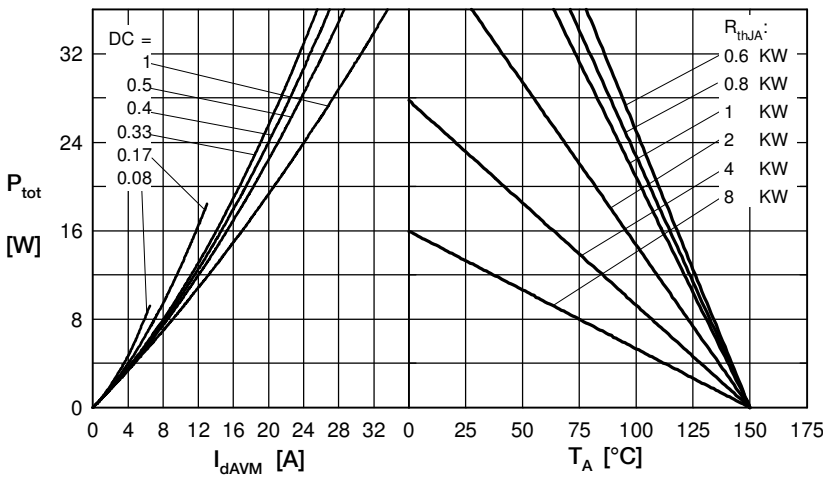

Fig. 4 Power dissipation vs. forward current and ambient temperature per diode

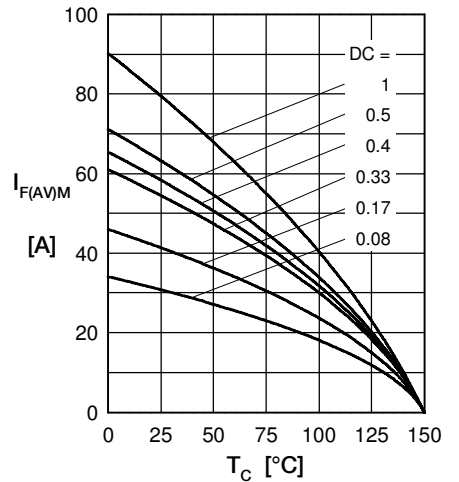

Fig. 5 Max. forward current vs. case temperature per diode

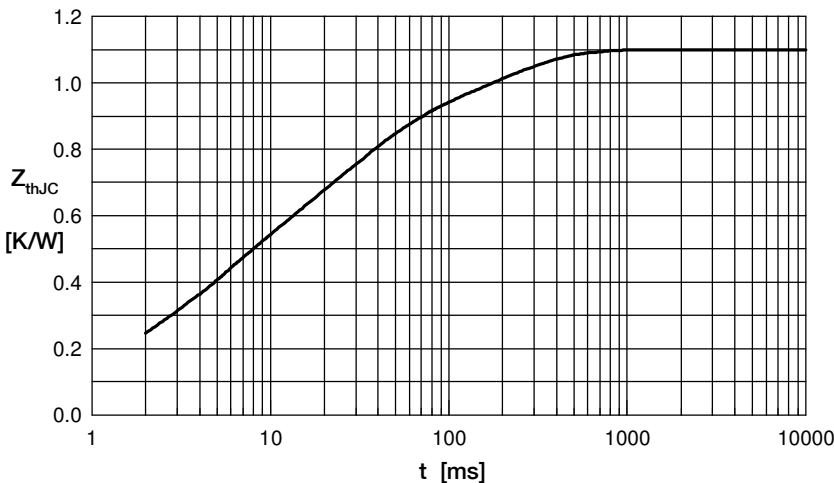

Fig. 6 Transient thermal impedance junction to case vs. time per diode

Constants for Z_{thJC} calculation:

i	R _{th} (K/W)	t _i (s)
1	0.0607	0.0004
2	0.1230	0.00256
3	0.2305	0.0045
4	0.4230	0.0242
5	0.2628	0.1800