

4 PIN DIP VERY HIGH ISOLATION VOLTAGE PHOTOCOUPLER

CNY64S series

Features

- High Voltage
BV_{CEO}=80V (min.)
- Operating temperature up to +85°C
- High isolation voltage between input and output
V_{IO_{TM}} = 8200 V perk for CNY64
V_{IO_{TM}} = 10000 V perk for CNY64-V
- Rated recurring peak voltage (repetitive)
V_{IO_{RM}} = 2200 V
- Creepage current resistance according to VDE 0303/IEC 60112
comparative tracking index: CTI ≥ 200
- Thickness through insulation ≥ 3mm
- Pb free and RoHS compliant.
- CUL approved (No. E214129)
- VDE approved (No. 40027351)
- FIMKO approved (No. 25464)

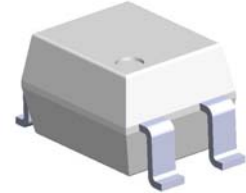

Description

The CNY64S series contains an infrared emitting diode optically coupled to a phototransistor.

These device is packaged in an 4-pin SMD package and providing a distance between input and output for highest safety requirement of >3mm.

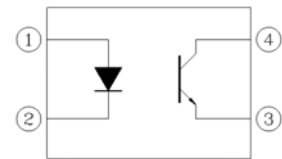

1. Anode
2. Cathode
3. Emitter
4. Collector

Applications

- Switch mode power supply
- Line receiver
- Computer peripheral interface
- Microprocessor system interface
- Circuits for safe protective separation against electrical shock according to safety class II (reinforced isolation):
 - for appl. class I - IV at mains voltage ≤ 300 V
 - for appl. class I - IV at mains voltage ≤ 600 V
 - for appl. class I - III at mains voltage ≤ 1000 V
 according to DIN EN 60747-5-5

4 PIN DIP VERY HIGH ISOLATION VOLTAGE PHOTOCOUPLER

CNY64S series

Absolute Maximum Ratings ($T_a=25^{\circ}\text{C}$)

Parameter		Symbol	Rating	Unit
Input	Forward current	I_F	75	mA
	Peak forward current (<10 μs)	I_{FM}	1.5	A
	Reverse voltage	V_R	5	V
	Power dissipation	P_D	120	mW
Output	Collector current	I_C	50	mA
	Collector power dissipation	P_C	150	mW
	Collector-Emitter voltage	V_{CEO}	80	V
	Emitter-Collector voltage	V_{ECO}	7	V
Total power dissipation		P_{tot}	250	mW
Isolation voltage ^{*1}		V_{iso}	8200	Vrms
Operating temperature		T_{opr}	-55~+85	$^{\circ}\text{C}$
Storage temperature		T_{stg}	-55~+100	$^{\circ}\text{C}$
Soldering temperature ^{*2}		T_{sol}	260	$^{\circ}\text{C}$

Notes

*1 AC for 1 minute, R.H.= 40 ~ 60% R.H. In this test, pins 1 & 2 are shorted together, and pins 3 & 4 are shorted together.

*2 2mm from case, <10 seconds.

4 PIN DIP VERY HIGH ISOLATION VOLTAGE PHOTOCOUPLER

CNY64S series

Electrical Characteristics (T_a=25°C unless specified otherwise)

Input

Parameter	Symbol	Min.	Typ.*	Max.	Unit	Condition
Forward voltage	V _F	-	1.6	2.0	V	I _F = 50mA
Reverse current	I _R	-	-	10	μA	V _R = 5V
Input capacitance	C _{in}	-	-	100	pF	V = 0, f = 1MHz

Output

Parameter	Symbol	Min.	Typ.*	Max.	Unit	Condition
Collector-Emitter dark current	I _{CEO}	-	-	200	nA	V _{CE} = 20V, I _F =0mA
Collector-Emitter breakdown voltage	BV _{CEO}	80	-	-	V	I _C = 1mA
Emitter-Collector breakdown voltage	BV _{ECO}	7	-	-	V	I _E = 0.1mA
Collector-Emitter capacitance	C _{CE}	-	-	50	pF	V _{CE} = 0V, f = 1MHz

Transfer Characteristics

Parameter	Symbol	Min.	Typ.*	Max.	Unit	Condition	
Current Transfer Ratio	CNY64	50	-	300	%	I _F = 5mA, V _{CE} = 5V	
	CNY64A	63	-	125			
	CNY64B	100	-	200			
Collector-emitter saturation voltage	V _{CE(sat)}	-	-	0.3	V	I _F = 10mA, I _C = 1mA	
Coupling capacitance	C _{IO}	-	0.3	-	pF	f=1MHz	
Isolation resistance	R _{IO}	10 ¹¹	-	-	Ω	V _{IO} = 500Vdc	
Turn-on time	T _{on}	-	6	18	μs	V _{CC} = 5V, I _C = 5mA, R _L = 100Ω	
Turn-off time	T _{off}	-	7	18			
Rise time	t _r	-	3	18		μs	V _{CC} = 5V, I _C = 5mA, R _L = 100Ω
Fall time	t _f	-	5	18			

* Typical values at T_a = 25°C



LIGHTING FOREVER

4 PIN DIP VERY HIGH ISOLATION VOLTAGE PHOTOCOUPLER

CNY64S series

Typical Performance Curves

Figure 1. Forward Current vs. Forward Voltage

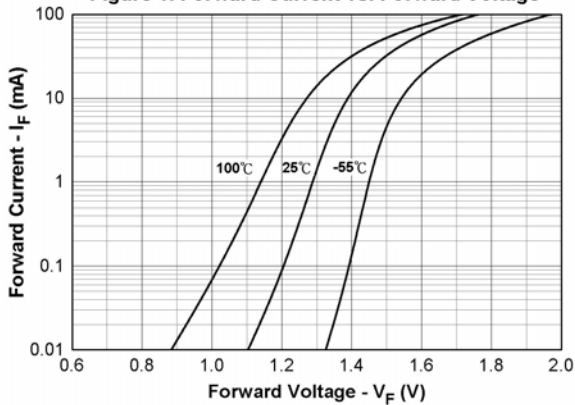

Figure 2. Normalized Current Transfer Ratio vs. Forward Current

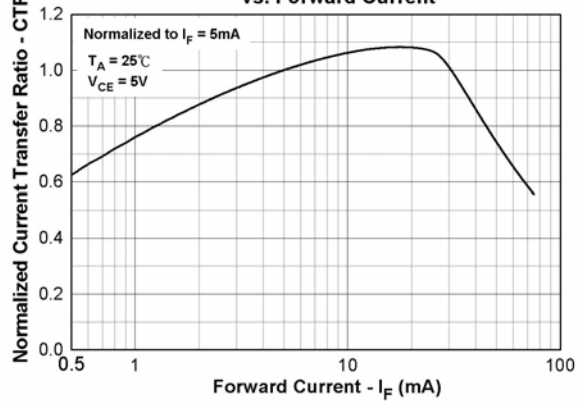

Figure 3. Normalized Current Transfer Ratio vs. Ambient Temperature

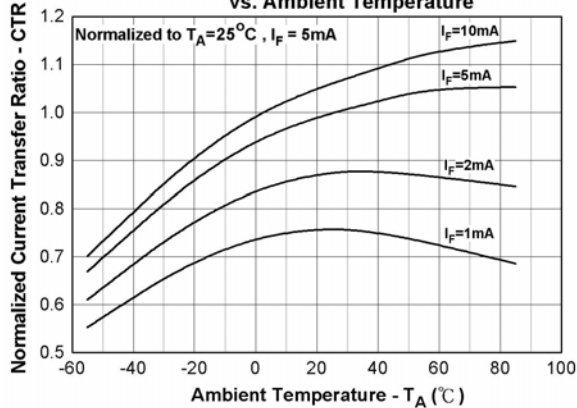

Figure 4. Collector Current vs. Forward Current

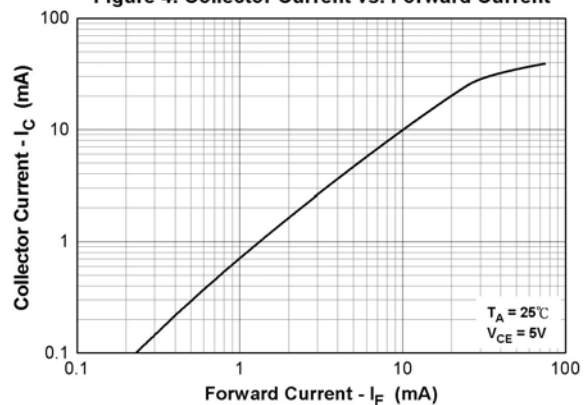

Figure 5. Collector-Emitter Saturation Voltage vs. Collector Current

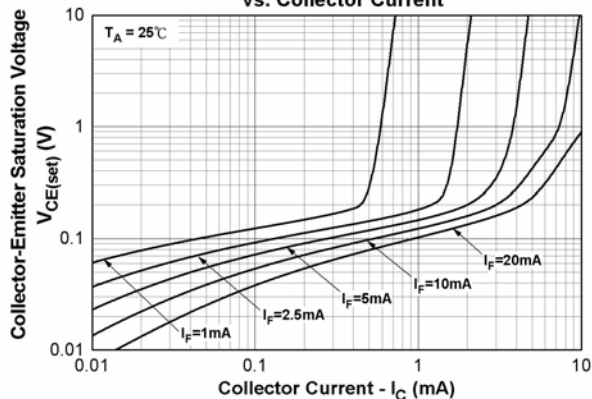
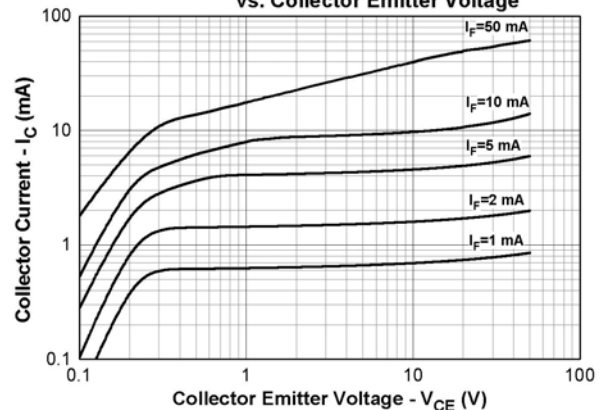

Figure 6. Collector Current vs. Collector Emitter Voltage



4 PIN DIP VERY HIGH ISOLATION VOLTAGE PHOTOCOUPLER

CNY64S series

Figure.7 Collector Dark Current vs. Ambient Temperature

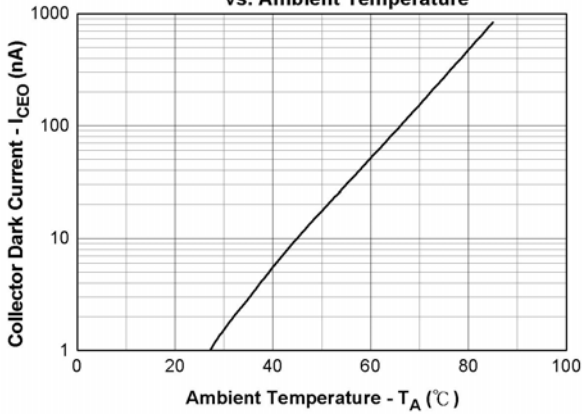

Figure 8. Turn on/off Time vs. Forward Current

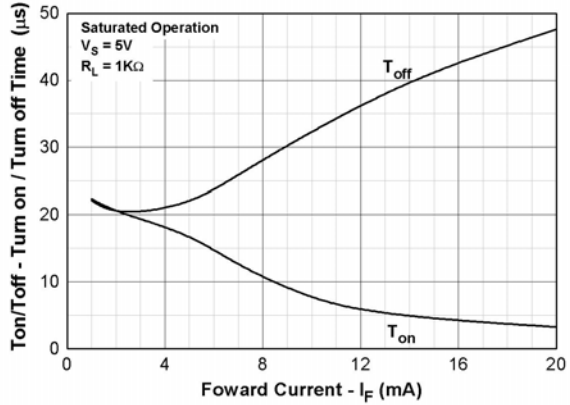

Figure 9. Turn on/off Time vs. Collector Current

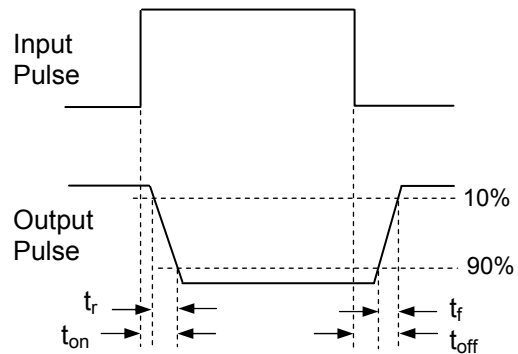
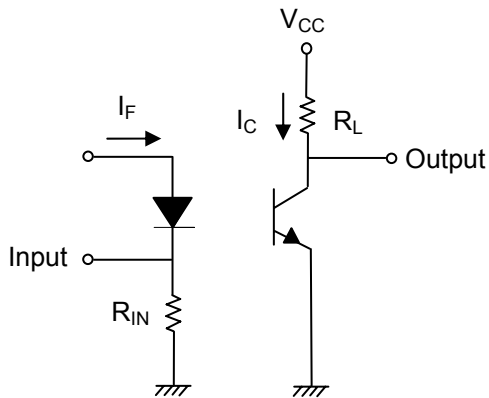
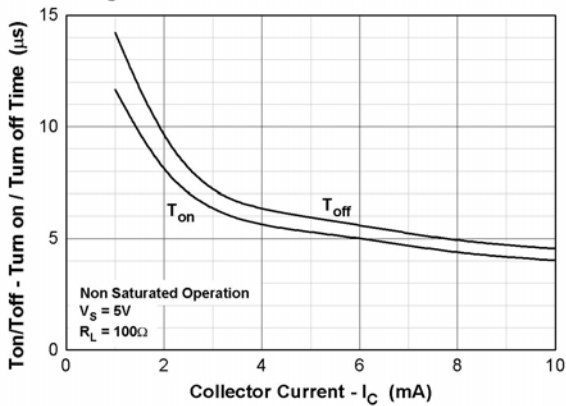

Figure 10. Switching Time Test Circuit & Waveforms



LIGHTING FOREVER

4 PIN DIP VERY HIGH ISOLATION VOLTAGE PHOTOCOUPLER

CNY64S series

Order Information

Part Number

CNY64SX-V

Note

X = CTR rank option (A, B or none)

V = VDE safety (optional)

Option	Description	Packing quantity
CNY64S	Standard	60 units per tube
CNY64S-V	Standard + VDE	60 units per tube
CNY64S(TA)	Standard	500 units per tube



LIGHTING FOREVER

4 PIN DIP VERY HIGH ISOLATION VOLTAGE PHOTOCOUPLER

CNY64S series

Package Drawings

(Dimensions in mm)

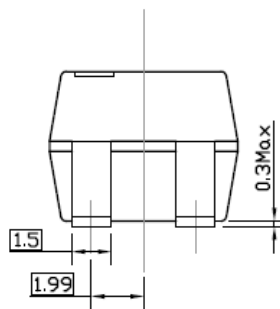
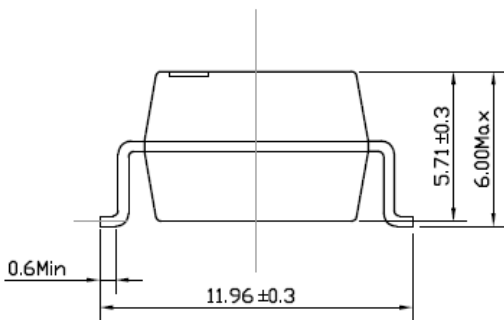
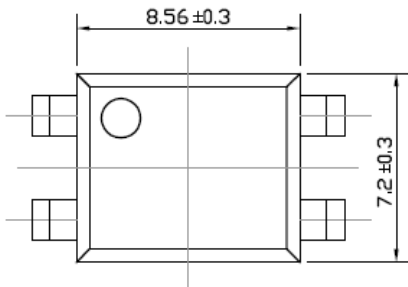

Recommended pad layout for surface mount leadform

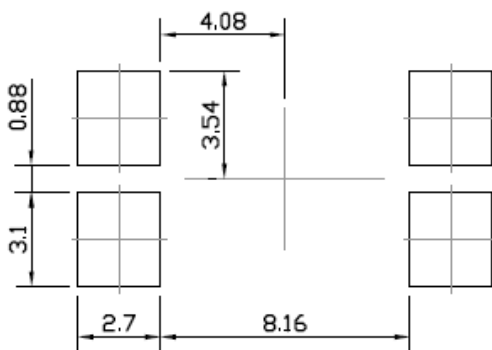



LIGHTING FOREVER

4 PIN DIP VERY HIGH ISOLATION VOLTAGE PHOTOCOUPLER

CNY64S series

Device Marking

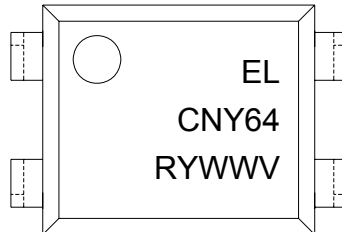

Notes

EL	denotes Everlight
CNY64	denotes Part no.
R	denotes CTR rank (A or B)
Y	denotes 1 digit Year code
WW	denotes 2 digit Week code
V	denotes VDE safety (optional)

4 PIN DIP VERY HIGH ISOLATION VOLTAGE PHOTOCOUPLER

CNY64S series

Tape & Reel Packing Specifications

Option TA

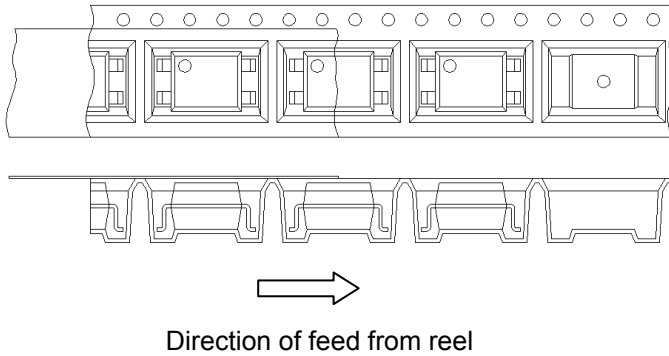

Tape dimensions

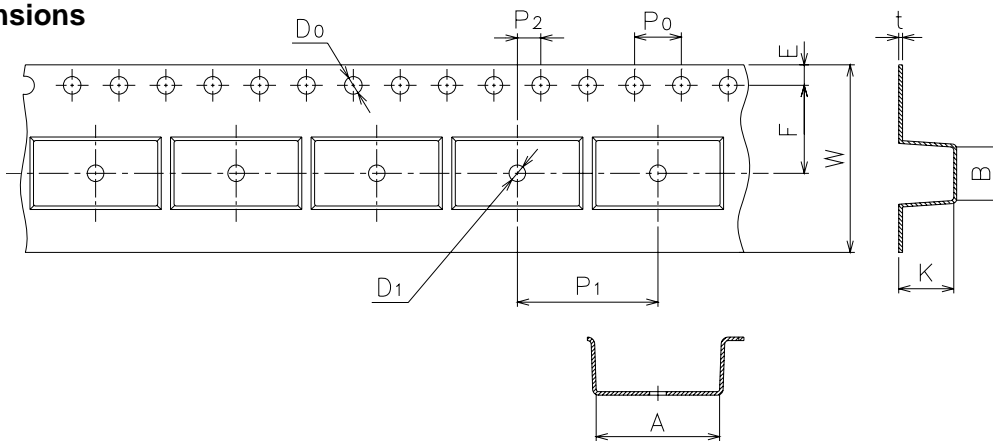

Dimension No.	A	B	Do	D1	E	F
Dimension(mm)	12.6±0.1	6.6±0.1	1.5+0.1/-0	1.5±0.1	1.75±0.1	7.5±0.1
Dimension No.	Po	P1	P2	t	W	K
Dimension(mm)	4.0±0.1	16.0±0.1	2.0±0.1	0.5±0.05	16.0±0.3	7.31±0.1



LIGHTING FOREVER

4 PIN DIP VERY HIGH ISOLATION VOLTAGE PHOTOCOUPLER

CNY64S series

Solder Reflow Temperature Profile

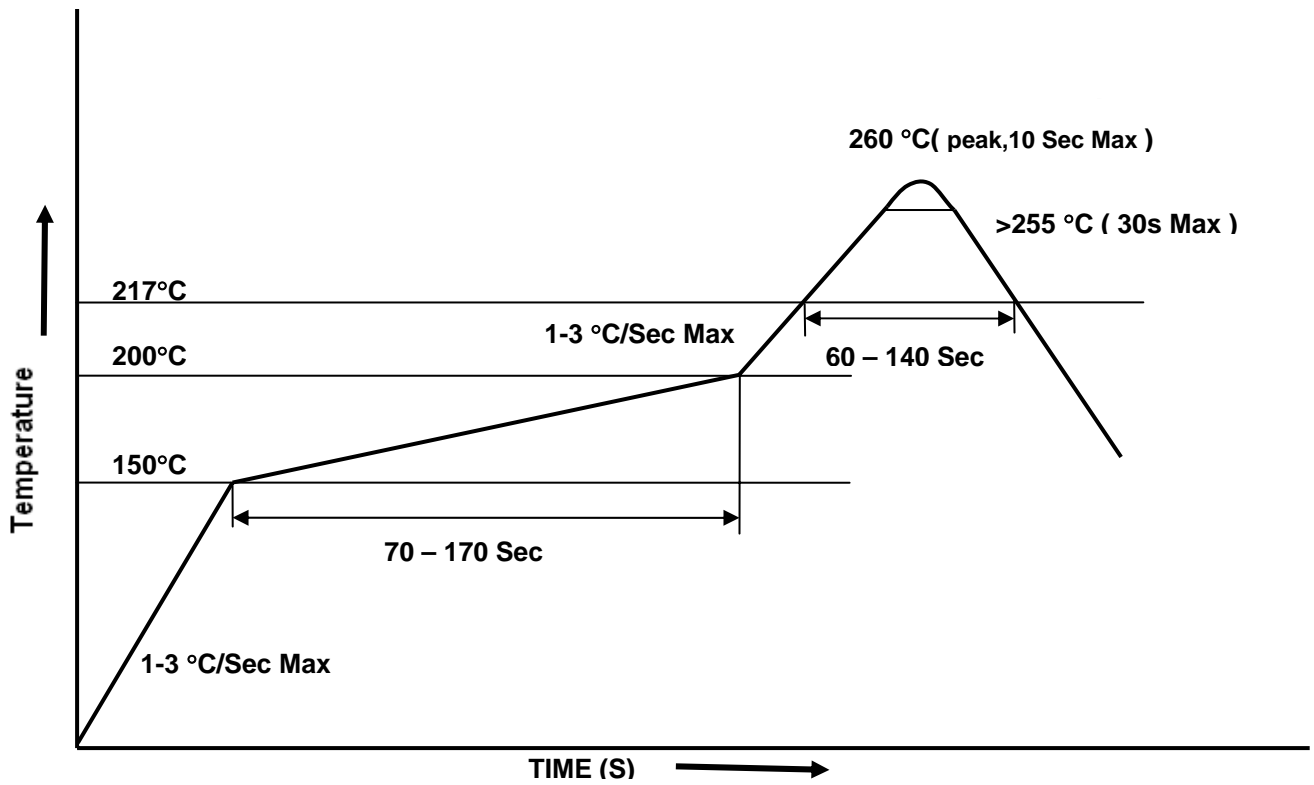



4 PIN DIP VERY HIGH ISOLATION VOLTAGE PHOTOCOUPLER

CNY64S series

DISCLAIMER

1. The specifications in this datasheet may be changed without notice. EVERLIGHT reserves the authority on material change for above specification.
2. When using this product, please observe the absolute maximum ratings and the instructions for use as outlined in this datasheet. EVERLIGHT assumes no responsibility for any damage resulting from use of the product which does not comply with the absolute maximum ratings and the instructions included in this datasheet.
3. These specification sheets include materials protected under copyright of EVERLIGHT. Reproduction in any form is prohibited without the specific consent of EVERLIGHT.