

Features

- Radial / Through hole package
- Reliable & robust
- Low power consumption
- Available on tape and reel
- RoHS Compliant

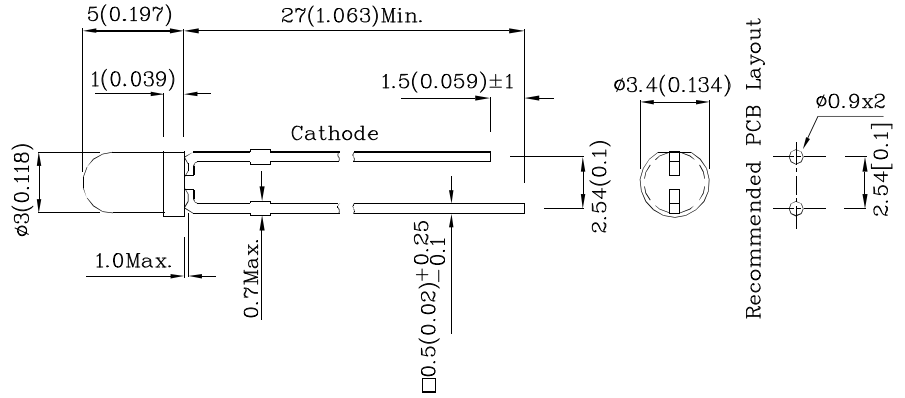

Package Schematics



Notes:

1. All dimensions are in millimeters (inches).
2. Tolerance is $\pm 0.25(0.01)$ unless otherwise noted.
3. Specifications are subject to change without notice.

Absolute Maximum Ratings ($T_A=25^\circ\text{C}$)		THI/850 (GaAlAs)	Unit
Reverse Voltage	V_R	5	V
Forward Current	I_F	50	mA
Forward Current (Peak) 1/10 Duty Cycle 0.1ms Pulse Width	iFS	1000	mA
Power Dissipation	P_D	80	mW
Operating Temperature	T_A	-40 ~ +85	°C
Storage Temperature	T_{stg}	-40 ~ +85	
Lead Solder Temperature [2mm Below Package Base]	260°C For 3 Seconds		
Lead Solder Temperature [5mm Below Package Base]	260°C For 5 Seconds		

Operating Characteristics ($T_A=25^\circ\text{C}$)		THI/850 (GaAlAs)	Unit
Forward Voltage (Typ.) ($I_F=20\text{mA}$)	V_F	1.4	V
Forward Voltage (Max.) ($I_F=20\text{mA}$)	V_F	1.6	V
Reverse Current (Max.) ($V_R=5\text{V}$)	I_R	10	μA
Wavelength of Peak Emission CIE127-2007* (Typ.) ($I_F=20\text{mA}$)	λ_P	850*	nm
Spectral Line Full Width At Half-Maximum (Typ.) ($I_F=20\text{mA}$)	$\Delta\lambda$	50	nm
Capacitance (Typ.) ($V_F=0\text{V}$, $f=1\text{MHz}$)	C	30	pF

A Relative Humidity between 40% and 60% is recommended in ESD-protected work areas to reduce static build up during assembly process (Reference JEDEC/JESD625-A and JEDEC/J-STD-033)

Part Number	Emitting Material	Lens-color	Radiant Intensity CIE127-2007* ($P_o=\text{mW/sr}$) @20mA		Radiant Intensity CIE127-2007* ($P_o=\text{mW/sr}$) @50mA		Wavelength CIE127-2007* nm λ_P	Viewing Angle 2 θ 1/2
			min.	typ.	min.	typ.		
XTHI30W850	GaAlAs	Water Clear	8*	15*	15*	49*	850*	50°

*Radiant intensity value and wavelength are in accordance with CIE127-2007 standards.

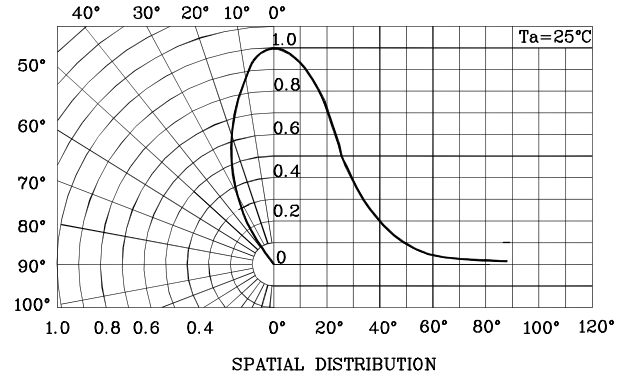
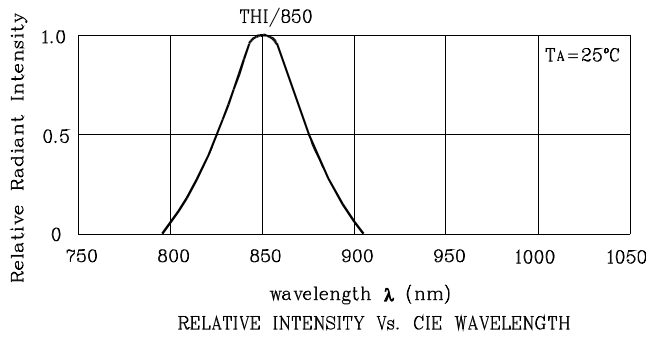

❖ THI/850

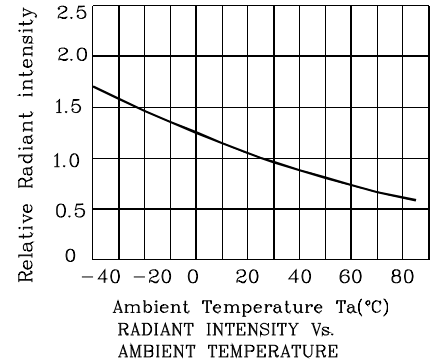
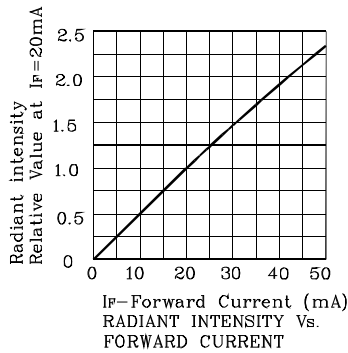
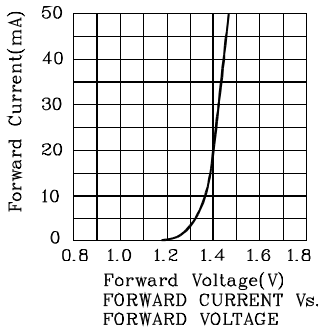

Wave Soldering Profile For Thru-Hole Products (Pb-Free Components)

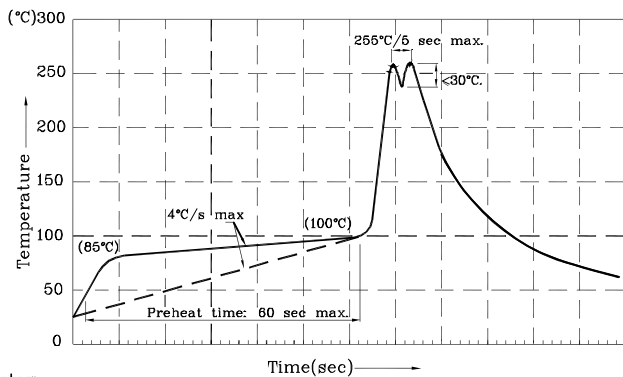



- Notes:
1. Recommend pre-heat temperature of 105°C or less (as measured with a thermocouple attached to the LED pins) prior to immersion in the solder wave with a maximum solder bath temperature of 280°C
 2. Peak wave soldering temperature between 245°C ~ 255°C for 3 sec (5 sec max).
 3. Do not apply stress to the epoxy resin while the temperature is above 85°C.
 4. Fixtures should not incur stress on the component when mounting and during soldering process.
 5. SAC 305 solder alloy is recommended.
 6. No more than one wave soldering pass.



Remarks:

- If special sorting is required (e.g. binning based on forward voltage, luminous intensity / luminous flux), the typical accuracy of the sorting process is as follows:
1. Radiant Intensity / Luminous Flux: +/-15%
 2. Forward Voltage: +/-0.1V

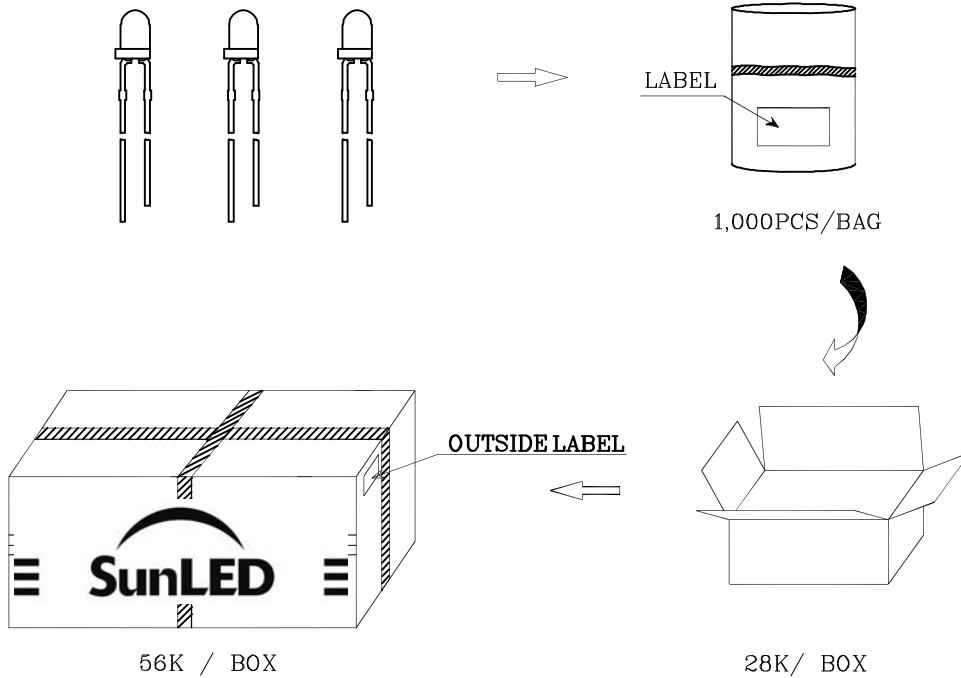
Note: Accuracy may depend on the sorting parameters.

PACKING & LABEL SPECIFICATIONS

	
P/NO : Xxxx30x	
QTY : 1,000 pcs	CODE: XXX
S/N : XX	
LOT NO:	
 XXXXXXXXXXXXXXXXXXXXXX	
RoHS Compliant	

TERMS OF USE

1. Data presented in this document reflect statistical figures and should be treated as technical reference only.
2. Contents within this document are subject to improvement and enhancement changes without notice.
3. The product(s) in this document are designed to be operated within the electrical and environmental specifications indicated on the datasheet. User accepts full risk and responsibility when operating the product(s) beyond their intended specifications.
4. The product(s) described in this document are intended for electronic applications in which a person's life is not reliant upon the LED. Please consult with a SunLED representative for special applications where the LED may have a direct impact on a person's life.
5. The contents within this document may not be altered without prior consent by SunLED.
6. Additional technical notes are available at <http://www.SunLEDusa.com/TechnicalNotes.asp>