

## Product Summary

$V_R$ (V)	$I_F$ (A)	$V_{F\ MAX}$ (V) @ +25°C	$I_{R\ MAX}$ (mA) @ +25°C
40	2.0	0.50	0.1

## Description and Applications

This Schottky Barrier Rectifier has been designed to meet the stringent requirements of Automotive Applications. It is ideally suited to use as :

- Polarity Protection Diode
- Re-circulating Diode
- Switching Diode

## Features and Benefits

- Guard Ring Die Construction for Transient Protection
- Low Power Loss, High Efficiency
- High Surge Capability
- High Current Capability and Low Forward Voltage Drop
- **Lead-Free Finish; RoHS Compliant (Notes 1 & 2)**
- **Halogen and Antimony Free. "Green" Device (Note 3)**
- **Qualified to AEC-Q101 Standards for High Reliability**
- **PPAP Capable (Note 4)**

## Mechanical Data

- Case: PowerDI123
- Case Material: Molded Plastic, "Green" Molding Compound. UL Flammability Classification Rating 94V-0
- Moisture Sensitivity: Level 1 per J-STD-020
- Terminal Connections: Cathode Band
- Terminals: Finish – Matte Tin Annealed Over Copper leadframe. Solderable per MIL-STD-202, Method 208 ③
- Weight: 0.01 grams (approximate)

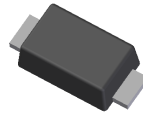

Top View

## Ordering Information (Note 5)

Part Number	Compliance	Case	Packaging
DFLS240LQ-7	Automotive	PowerDI <sup>®</sup> 123	3000/Tape & Reel

- Notes:
1. EU Directive 2002/95/EC (RoHS) & 2011/65/EU (RoHS 2) compliant. All applicable RoHS exemptions applied.
  2. See [http://www.diodes.com/quality/lead\\_free.html](http://www.diodes.com/quality/lead_free.html) for more information about Diodes Incorporated's definitions of Halogen- and Antimony-free, "Green" and Lead-free.
  3. Halogen- and Antimony-free "Green" products are defined as those which contain <900ppm bromine, <900ppm chlorine (<1500ppm total Br + Cl) and <1000ppm antimony compounds.
  4. Automotive products are AEC-Q101 qualified and are PPAP capable. Automotive, AEC-Q101 and standard products are electrically and thermally the same, except where specified. For more information, please refer to [http://www.diodes.com/quality/product\\_compliance\\_definitions/](http://www.diodes.com/quality/product_compliance_definitions/).
  5. For packaging details, go to our website at <http://www.diodes.com/products/packages.html>.

## Marking Information



F06A = Product Type Marking Code  
 YM = Date Code Marking  
 Y = Year (ex: B = 2014)  
 M = Month (ex: 9 = September)

### Date Code Key

Year	2014	2015	2016	2017	2018	2019	2020	2021	2022
Code	B	C	D	E	F	G	H	I	J

Month	Jan	Feb	Mar	Apr	May	Jun	Jul	Aug	Sep	Oct	Nov	Dec
Code	1	2	3	4	5	6	7	8	9	O	N	D

**Maximum Ratings** (@ $T_A = +25^\circ\text{C}$ , unless otherwise specified.)

Single phase, half wave, 60Hz, resistive or inductive load.  
For capacitance load, derate current by 20%.

Characteristic	Symbol	Value	Unit
Peak Repetitive Reverse Voltage Working Peak Reverse Voltage DC Blocking Voltage	$V_{RRM}$ $V_{RWM}$ $V_R$	40	V
RMS Reverse Voltage	$V_{R(RMS)}$	28	V
Average Forward Current	$I_{F(AV)}$	2.0	A
Non-Repetitive Peak Forward Surge Current 8.3ms Single Half Sine-Wave Superimposed on Rated Load	$I_{FSM}$	50	A

**Thermal Characteristics**

Characteristic	Symbol	Typ	Max	Unit
Power Dissipation (Note 6)	$P_D$	—	1.67	W
Power Dissipation (Note 7)	$P_D$	—	556	mW
Thermal Resistance Junction to Ambient (Note 6)	$R_{\theta JA}$	60	—	$^\circ\text{C/W}$
Thermal Resistance Junction to Ambient (Note 7)	$R_{\theta JA}$	180	—	$^\circ\text{C/W}$
Thermal Resistance Junction to Soldering (Note 8)	$R_{\theta JS}$	—	5	$^\circ\text{C/W}$
Operating Temperature Range	$T_J$	-55 to +125		$^\circ\text{C}$
Storage Temperature Range	$T_{STG}$	-55 to +150		$^\circ\text{C}$

**Electrical Characteristics** (@ $T_A = +25^\circ\text{C}$ , unless otherwise specified.)

Characteristic	Symbol	Min	Typ	Max	Unit	Test Condition
Reverse Breakdown Voltage (Note 10)	$V_{(BR)R}$	40	—	—	V	$I_R = 500\mu\text{A}$ , $T_A = +25^\circ\text{C}$
Forward Voltage	$V_F$	—	0.4 0.45 0.50	0.45 0.50 0.65	V	$I_F = 1.0\text{A}$ , $T_A = +25^\circ\text{C}$ $I_F = 2.0\text{A}$ , $T_A = +25^\circ\text{C}$ $I_F = 3.0\text{A}$ , $T_A = +25^\circ\text{C}$
Leakage Current (Note 10)	$I_R$	—	—	0.1 10 0.05 5	mA	$V_R = 40\text{V}$ , $T_A = +25^\circ\text{C}$ $V_R = 40\text{V}$ , $T_A = +85^\circ\text{C}$ $V_R = 20\text{V}$ , $T_A = +25^\circ\text{C}$ $V_R = 20\text{V}$ , $T_A = +85^\circ\text{C}$
Total Capacitance	$C_T$	—	90	—	pF	$V_R = 10\text{V}$ , $f = 1.0\text{MHz}$

- Notes:
- Part mounted on 50.8mm X 50.8mm GETEK board with 25.4mm X 25.4mm copper pad, 25% anode, 75% cathode.
  - Part mounted on FR-4 board with 1.8mm X 2.5mm cathode and 1.8mm X 1.2mm anode, 1 oz. copper pads.
  - Theoretical  $R_{\theta JS}$  calculated from the top center of the die straight down to the PCB cathode tab solder junction.
  - EU Directive 2002/95/EC (RoHS). All applicable RoHS exemptions applied. Please visit our website at [http://www.diodes.com/products/lead\\_free.html](http://www.diodes.com/products/lead_free.html).
  - Short duration pulse test used to minimize self-heating effect.

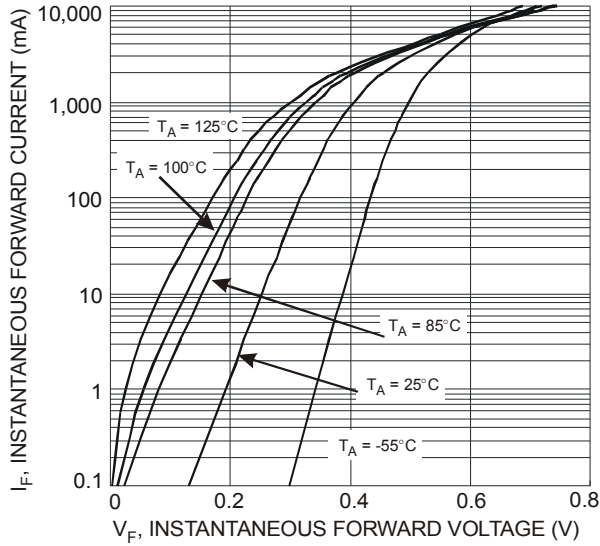

Figure 1 Typical Forward Characteristics

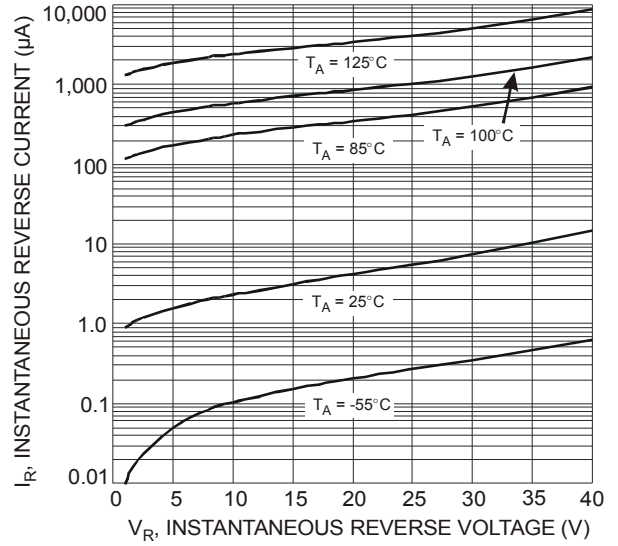

Figure 2 Typical Reverse Characteristics

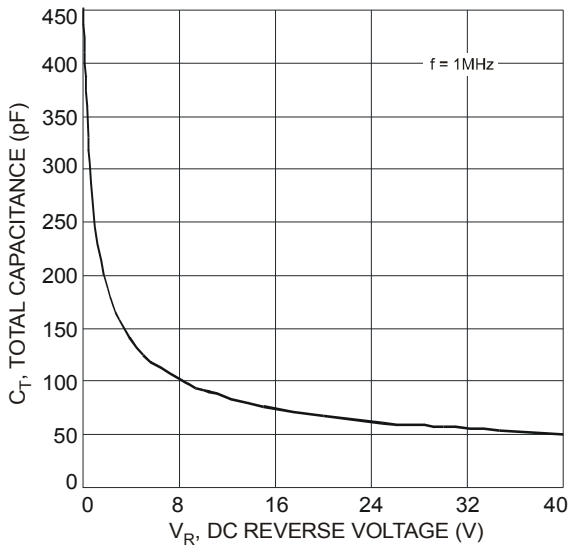

Figure 3 Total Capacitance vs. Reverse Voltage

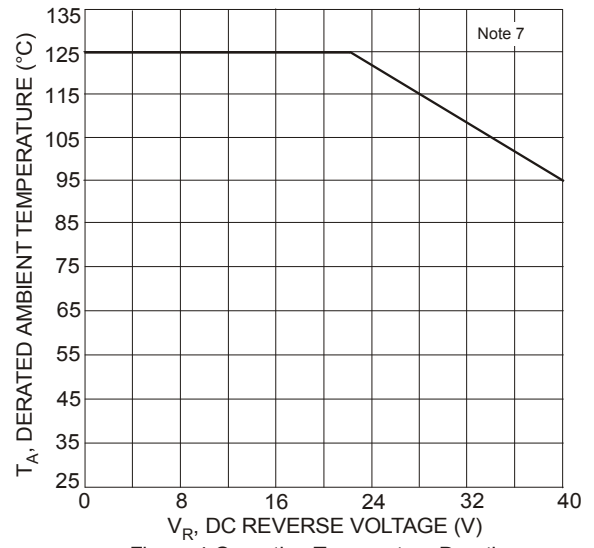
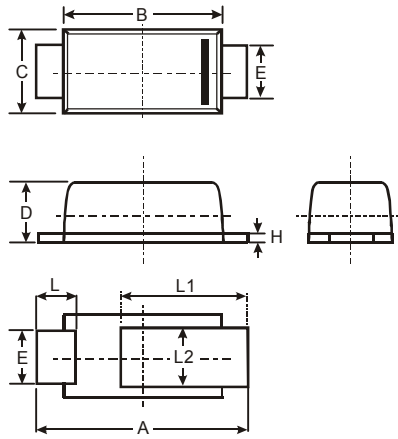

Figure 4 Operating Temperature Derating

**Package Outline Dimensions**

Please see AP02002 at <http://www.diodes.com/datasheets/ap02002.pdf> for latest version.



PowerDI <sup>®</sup> 123			
Dim	Min	Max	Typ
A	3.50	3.90	3.70
B	2.60	3.00	2.80
C	1.63	1.93	1.78
D	0.93	1.00	0.98
E	0.85	1.25	1.00
H	0.15	0.25	0.20
L	0.55	0.75	0.65
L1	1.80	2.20	2.00
L2	0.95	1.25	1.10
All Dimensions in mm			

**Suggested Pad Layout**

Please see AP02001 at <http://www.diodes.com/datasheets/ap02001.pdf> for latest version.

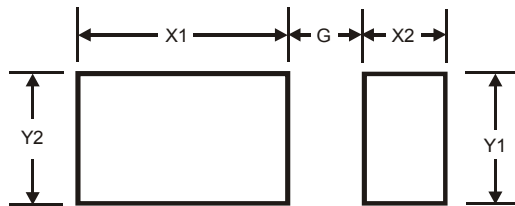

Dimensions	Value (in mm)
G	1.0
X1	2.2
X2	0.9
Y1	1.4
Y2	1.4

#### IMPORTANT NOTICE

DIODES INCORPORATED MAKES NO WARRANTY OF ANY KIND, EXPRESS OR IMPLIED, WITH REGARDS TO THIS DOCUMENT, INCLUDING, BUT NOT LIMITED TO, THE IMPLIED WARRANTIES OF MERCHANTABILITY AND FITNESS FOR A PARTICULAR PURPOSE (AND THEIR EQUIVALENTS UNDER THE LAWS OF ANY JURISDICTION).

Diodes Incorporated and its subsidiaries reserve the right to make modifications, enhancements, improvements, corrections or other changes without further notice to this document and any product described herein. Diodes Incorporated does not assume any liability arising out of the application or use of this document or any product described herein; neither does Diodes Incorporated convey any license under its patent or trademark rights, nor the rights of others. Any Customer or user of this document or products described herein in such applications shall assume all risks of such use and will agree to hold Diodes Incorporated and all the companies whose products are represented on Diodes Incorporated website, harmless against all damages.

Diodes Incorporated does not warrant or accept any liability whatsoever in respect of any products purchased through unauthorized sales channel. Should Customers purchase or use Diodes Incorporated products for any unintended or unauthorized application, Customers shall indemnify and hold Diodes Incorporated and its representatives harmless against all claims, damages, expenses, and attorney fees arising out of, directly or indirectly, any claim of personal injury or death associated with such unintended or unauthorized application.

Products described herein may be covered by one or more United States, international or foreign patents pending. Product names and markings noted herein may also be covered by one or more United States, international or foreign trademarks.

This document is written in English but may be translated into multiple languages for reference. Only the English version of this document is the final and determinative format released by Diodes Incorporated.

#### LIFE SUPPORT

Diodes Incorporated products are specifically not authorized for use as critical components in life support devices or systems without the express written approval of the Chief Executive Officer of Diodes Incorporated. As used herein:

A. Life support devices or systems are devices or systems which:

1. are intended to implant into the body, or
2. support or sustain life and whose failure to perform when properly used in accordance with instructions for use provided in the labeling can be reasonably expected to result in significant injury to the user.

B. A critical component is any component in a life support device or system whose failure to perform can be reasonably expected to cause the failure of the life support device or to affect its safety or effectiveness.

Customers represent that they have all necessary expertise in the safety and regulatory ramifications of their life support devices or systems, and acknowledge and agree that they are solely responsible for all legal, regulatory and safety-related requirements concerning their products and any use of Diodes Incorporated products in such safety-critical, life support devices or systems, notwithstanding any devices- or systems-related information or support that may be provided by Diodes Incorporated. Further, Customers must fully indemnify Diodes Incorporated and its representatives against any damages arising out of the use of Diodes Incorporated products in such safety-critical, life support devices or systems.

Copyright © 2014, Diodes Incorporated

[www.diodes.com](http://www.diodes.com)