

Designated client product

This product will be discontinued its production in the near term.
And it is provided for customers currently in use only, with a time limit.
It can not be available for your new project. Please select other new or existing products.

For more information, please contact our sales office in your region.

New Japan Radio Co.,Ltd.

<http://www.njr.com/>

SWITCHING REGULATOR CONTROL CIRCUIT

■ GENERAL DESCRIPTION

The NJM3524 of regulating pulse width modulators contains all of the control circuitry necessary to implement switching regulators of either polarity converters and voltage doublers, as well as other power control applications. This device includes a 5V voltage regulator capable of supplying up to 50mA to external circuitry a control amplifier, an oscillator, a pulse width modulator, a phase splitting flip-flop, dual alternating output switch transistors, and current limiting and shut-down circuitry. Both the regulator output transistor and each output switch are internally current limited and, to limit junction temperature, an internal thermal shut-down circuit is employed.

■ PACKAGE OUTLINE

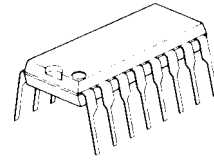

NJM3524D

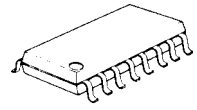

NJM3524M

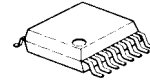

NJM3524V

■ FEATURES

- Operating Voltage (8V to 40V)
- Complete PWM Power Control Circuitry
- Uncommitted Outputs for Single-Ended or Push-Pull Applications
- Low Stand by Current
- Package Outline DIP16, DMP16, SSOP16
- Bipolar Technology

■ RECOMMEND OPERATING CONDITION

Parameter	Symbol	Min.	Typ.	Max.	Unit
Operating Voltage	V^+	8	20	40	V
Output Reference Current	I_{REF}	0	-	50	mA
Timing Resistance	R_T	1.8	-	100	k Ω
Timing Capacitor	C_T	-	-	0.1	μ F
Operating Temperature Range	T_{opr}	-20	25	75	$^{\circ}$ C

■ PIN CONFIGURATION

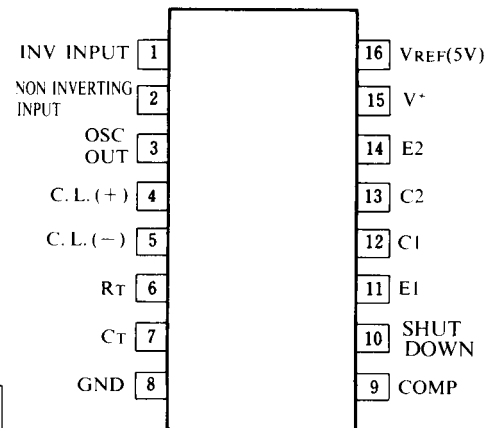

■ EQUIVALENT CIRCUIT

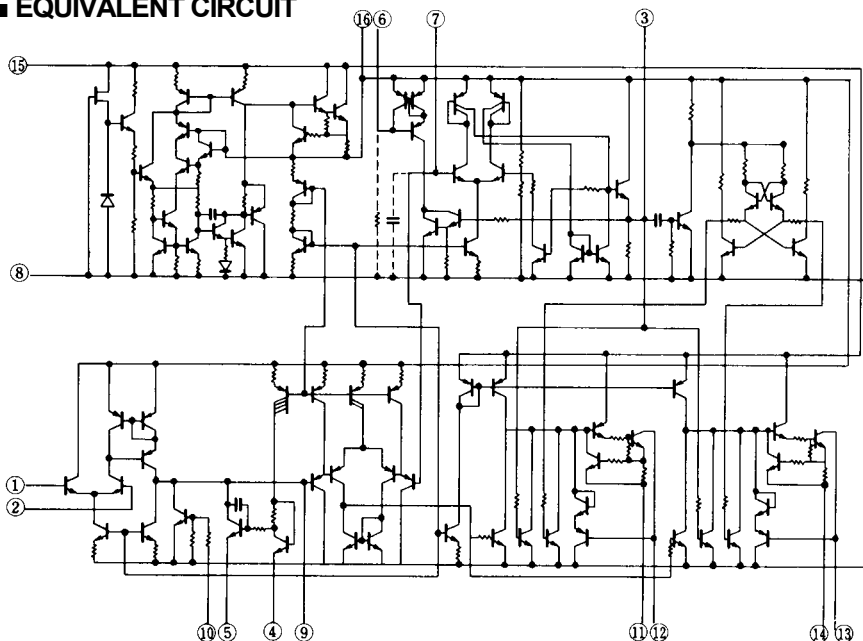

NJM3524

■ ABSOLUTE MAXIMUM RATINGS

(T_a = 25°C)

PARAMETER	SYMBOL	RATINGS	UNIT
Supply Voltage	V ⁺	40	V
Output Current	I _o	100	mA
Output Reference Current	I _{REF}	50	mA
Power Dissipation	P _D	(DIP16) 700 (DMP16) 300	mW mW
Operating Temperature Range	T _{opr}	-20 to +75	°C
Storage Temperature Range	T _{stg}	-40 to +125	°C

■ ELECTRICAL CHARACTERISTICS

Electrical characteristics over recommended operating free-air temperature range, V⁺ = 20V, f = 20kHz
(unless otherwise noted).

Reference Section

PARAMETER	SYMBOL	TEST CONDITION	MIN.	TYP.	MAX.	UNIT
Output Voltage	V _{REF}	V ⁺ = 20V	4.6	5.0	5.4	V
Line Regulation	ΔV _{REF} -V ⁺	V ⁺ = 8 to 40V	-	10	30	mV
Load Regulation	ΔV _{REF} -I _{REF}	V ⁺ = 10V, I _{REF} = 0 to 20mA	-	20	50	mV
Ripple Rejection	RR	V ⁺ = 20V, f = 120Hz	-	66	-	dB
Temperature Coefficient	T. C.	T _a = -20 to +75°C	-	-1	-	mV/°C
Short Circuit Output Current	I _{REFS}		-	100	-	mA

Error Amplifier Section

Input Offset Voltage	V _{IO}	V _{IC} = 2.5V	-	2	10	mV
Input Bias Current	I _B (1)	V _{IC} = 2.5V	-	2	10	μA
Open Loop Voltage Gain	A _v		60	80	-	dB
Input Common Mode Voltage Range	V _{CM}	T _a = 25°C	1.8	-	3.4	V
Common Mode Rejection Ratio	CMR		-	70	-	dB
Unity Gain Bandwidth	-		-	3	-	MHz
Output Voltage Swing	-		0.5	-	3.8	V

Oscillator Section

Frequency	f _{osc}	C _T = 0.01μF, R _T = 2kΩ	-	30	-	kHz
Frequency Change with Voltage	-	V ⁺ = 8 to 40V	-	-	1	%
Frequency Change with Temperature	-	T _a = -20 to +75°C	-	-	3	%
Output Pulse Width (Pin 3)	-	C _T = 0.01μF	-	0.5	-	μS
Output Amplitude (Pin 3)	-		-	3.5	-	V

Comparator Section

Maximum Duty Cycle	-		0	-	45	%
Input Threshold (Pin 9)	V_{IH}	"0" duty cycle	-	1.0	-	V
Input Threshold (Pin 9)	V_{IH}	"Max" duty cycle	-	3.5	-	V
Input Bias Current	$I_B(2)$		-	1	-	μA

Current Limiting Section

Input Voltage Range	-		-0.7	-	+1.0	V
Sense Voltage	-	$V_{(2)} - V_{(1)} \geq 50mV$	180	200	220	mV
Sense Voltage Temperature Coefficient	-		-	0.2	-	mV/°C

Output Section

Collector-Emitter Breakdown Voltage	V_{CER}		40	-	-	V
Collector Leakage Current	I_{CER}	$V_{CE} = 40V$	-	0.1	50	μA
Collector-Emitter Saturation Voltage	$V_{CE(SAT)}$	$I_O = 50mA$	-	1	2	V
Emitter Output Voltage	-	$V^+ = 20V, I_F = -250\mu A$	17	18	-	V
Turn-off Voltage Rise Time	T_r	$R_C = 2k\Omega$	-	0.2	-	μS
Turn-on Voltage Fall Time	T_f	$R_C = 2k\Omega$	-	0.1	-	μS

Total Device

Standby Current	I_Q	$V^+ = 40V, Pin_{(2)} = 2V$ 1, 4, 7, 8, 9, 11, 14 = GND All Other Inputs and Outputs Open	-	8	10	mA
-----------------	-------	---	---	---	----	----

■ BLOCK DIAGRAM

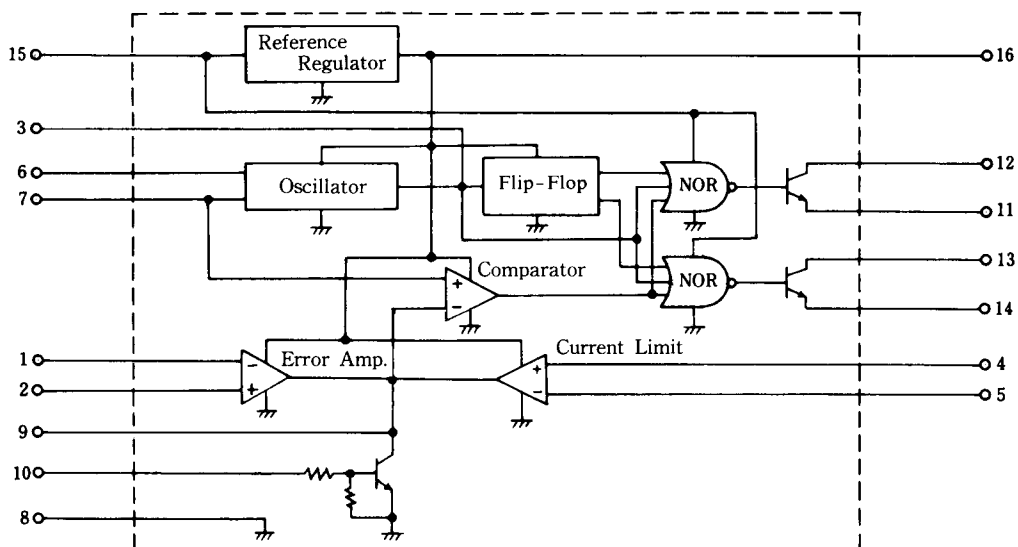

■ ERROR AMPLIFIER BIAS CIRCUITS

(A) Positive Output

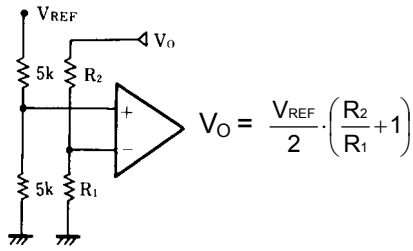

(B) Negative Output

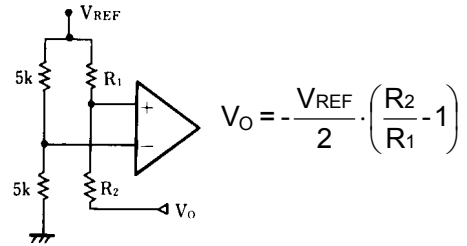

■ CURRENT LIMIT

- (a) Take the detection output from the ground line side, because the input voltage range is -0.7V to +1.0V.
- (b) The sensing voltage is 200mV typical.

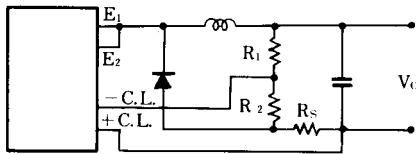

$$I_{O(MAX)} = \frac{1}{R_S} \left(V_{SENSE} + \frac{R_2}{R_1 + R_2} V_O \right)$$

$$I_{OS} = \frac{V_{SENSE}}{R_S}$$

■ SOFT START METHOD

It is possible that the output stage is broken due to a wrong operation of circuits simultaneously when supply voltage was applied. This failure can be prevented by setting the error amplifier output to a low level for a certain time as shown in the right figure.

In this case, the soft start time is determined by the time constant of R_B and C_B .

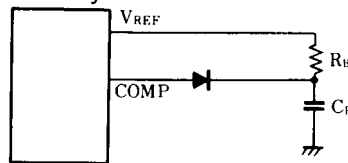

■ OUTPUT CONFIGURATIONS

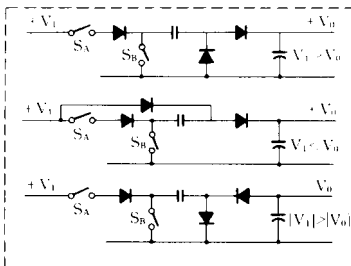

Capacitor-Diode-Coupled
Voltage Multiplier Output stage

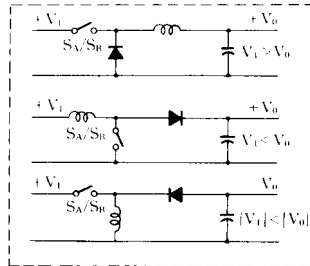

Single-Ended Inductor Circuit

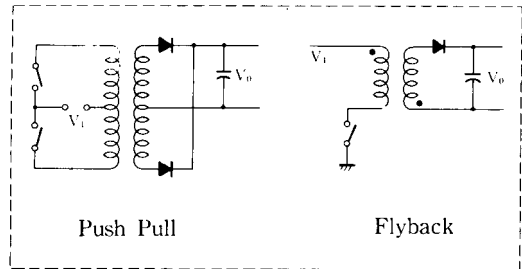

Transformer-Coupled Outputs

■ TYPICAL APPLICATIONS

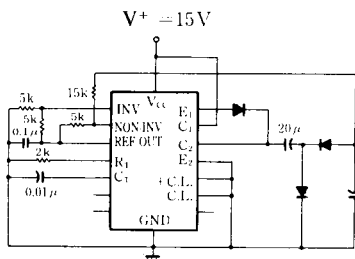

Fig. 1 Capacitor-Diode Output Circuit

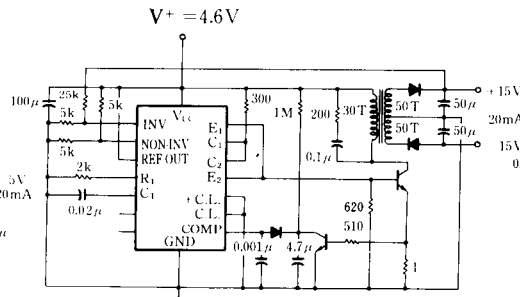

Fig. 2 Flyback Converter Circuit

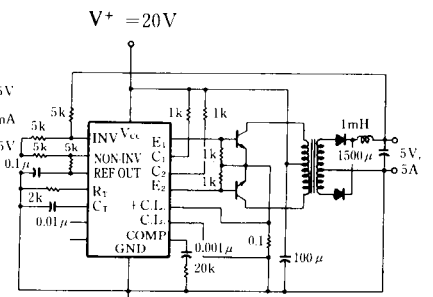
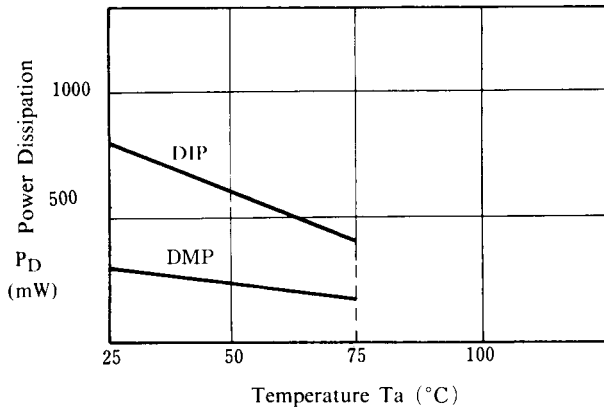

Fig. 3 Push-Pull
Transformer-Coupled Circuit

■ POWER DISSIPATION VS. AMBIENT TEMPERATURE



■ TYPICAL CHARACTERISTICS

Reference Voltage vs. Operating Voltage

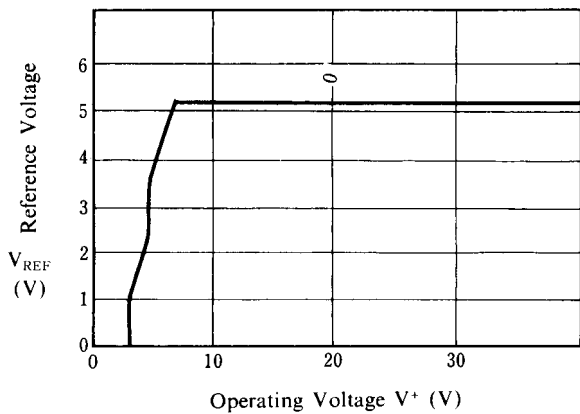

Standby Current vs. Operating Voltage

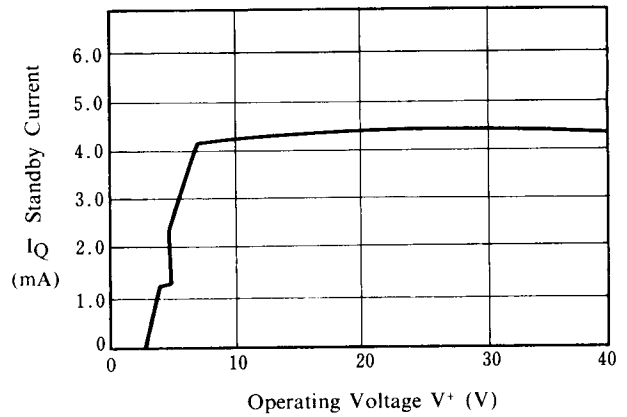

Open Loop Voltage Gain vs. Frequency

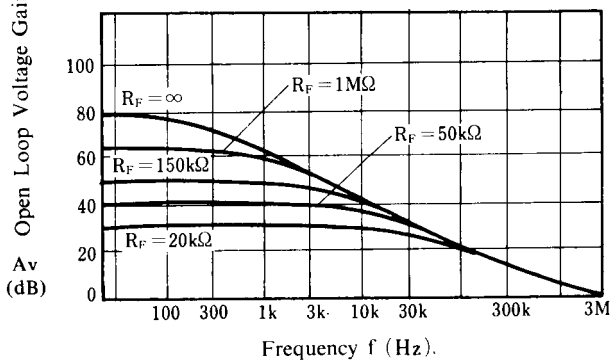

R_T , C_T vs. Frequency

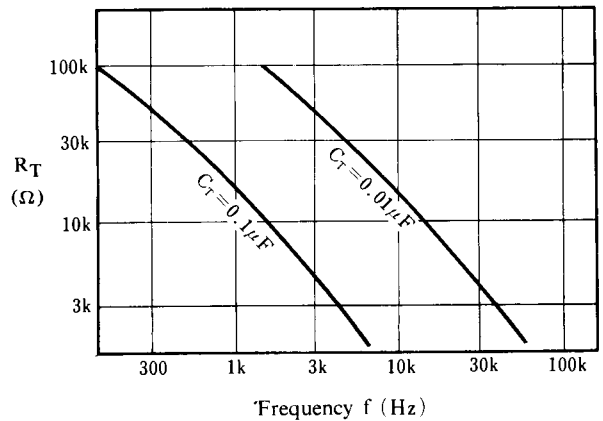

[CAUTION]

The specifications on this databook are only given for information, without any guarantee as regards either mistakes or omissions. The application circuits in this databook are described only to show representative usages of the product and not intended for the guarantee or permission of any right including the industrial rights.