

Assembly - View From Bottom

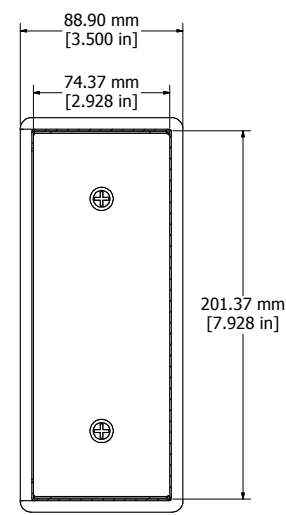

SECTION A-A

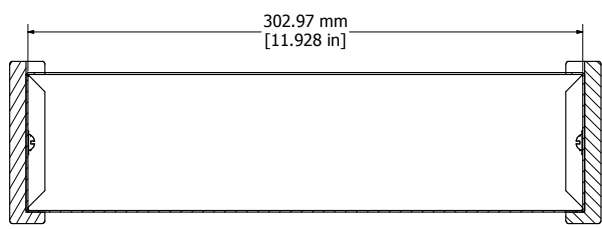
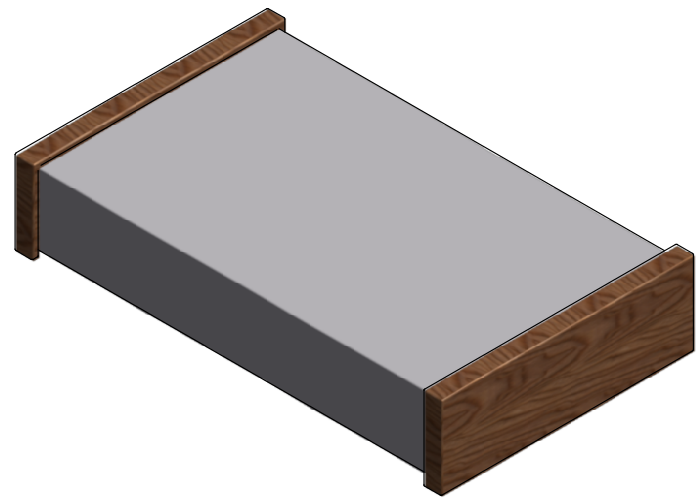

SECTION B-B

Purchased Assembly Includes Walnut Sides, Steel Or Aluminum Chassis, Rubber Feet, 4 Lock Washers And 4 Assembly Screws.

Screws Should Not Be Torqued Pass 4.43 lbf.in (50 cN.m)

PART NUMBERS

1444-32CWW

Component	Description	Part Number
Chassis	Aluminum Chassis 7X5X2	COM56812-5
Insert	Hardwood Insert	HWINSERT
Screw	8-32 X5/16 Truss Head	SC1440
Washer	#8 Ext. Tooth Lock Washer	WA201
Sides	1441-12 Walnut Side	PFR1441-32HW
Feet	Hardwood Chassis Rubber Feet Set	SC1440-D

Contact Factory mjm@hammondmfg.com for quotes
 Enclosures can be Factory Modified (Milling, Drilling, Printing etc.)
 Solid models of this enclosure available in STEP or IGES.



**HAMMOND
MANUFACTURING INC.**

1444-32CWW

www.hammondmfg.com