

RS1A-RS1M SURFACE MOUNT SUPER FAST RECTIFIER

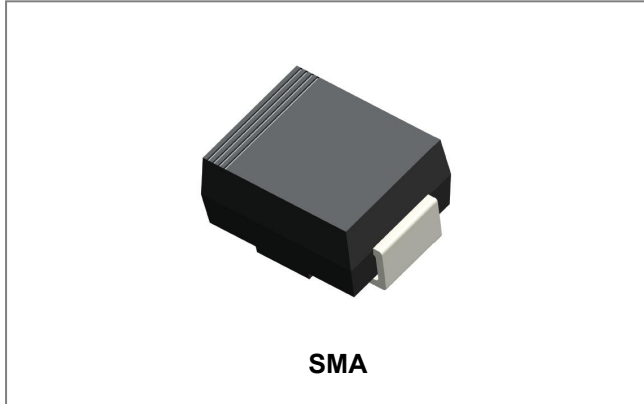

Features

- The plastic package carries Underwriters Laboratory Flammability Classification 94V-0
- For surface mounted applications
- Fast switching for high efficiency
- Low reverse leakage
- Built-in strain relief, ideal for automated placement
- High forward surge current capability
- High temperature soldering guaranteed:
250 °C/10 seconds at terminals
- This is a Pb – Free Device
- All SMC parts are traceable to the wafer lot
- Additional testing can be offered upon request

Circuit Diagram



Mechanical Data

- Case: SMA molded plastic body
- Terminals: Solder plated, solderable per MIL-STD-750, Method 2026
- Polarity: Color band denotes cathode end
- Mounting Position: Any
- Weight: 0.06 grams

Maximum Ratings and Electrical Characteristics @T_A=25°C unless otherwise specified

Type Number	Symbol	RS1A	RS1B	RS1D	RS1G	RS1J	RS1K	RS1M	Units	
Peak Repetitive Reverse Voltage	V _{RRM}									
Working Peak Reverse Voltage	V _{RWM}	50	100	200	400	600	800	1000	V	
DC Blocking Voltage	V _{DC}									
RMS Reverse Voltage	V _{RMS}	35	70	140	280	420	560	700	V	
Average forward rectified output current @T _L = 90°C	I _o	1.0								A
Non-Repetitive Peak Forward Surge Current 8.3ms Single half sine-wave superimposed on rated load (JEDEC Method)	I _{FSM}	30								A
Forward Voltage @I _F =1.0A	V _F	1.3								V
Peak Reverse Current @T _A = 25°C	I _{RM}	5.0								µA
At Rated DC Blocking Voltage @T _A = 100°C		50								
Maximum Reverse Recovery Time (Note 1)	T _{rr}	150				250	500		ns	
Typical Junction Capacitance (Note 2)	C _J	15								pF
Typical Thermal Resistance Junction to Ambient (Note 3)	R _{θJA}	50								°C/W
Operating and Storage Temperature Range	T _J , T _{STG}	-55 to +150								°C

Note: 1. Reverse recovery condition I_F=0.5A, I_R=1.0A, I_{rr}=0.25A
2. Measured at 1MHz and applied reverse voltage of 4.0V D.C.
3. Mounted on P.C.B.with 8.0mm² land areas.

- China - Germany - Korea - Singapore - United States •
- <http://www.smc-diodes.com> - sales@smc-diodes.com •

Ratings and Characteristics Curves

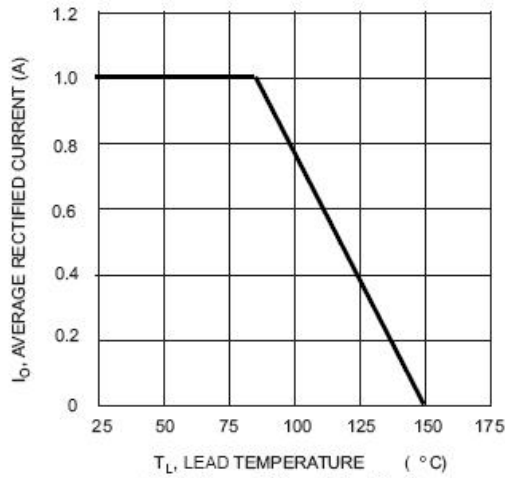

Fig. 1 Forward Current Derating Curve

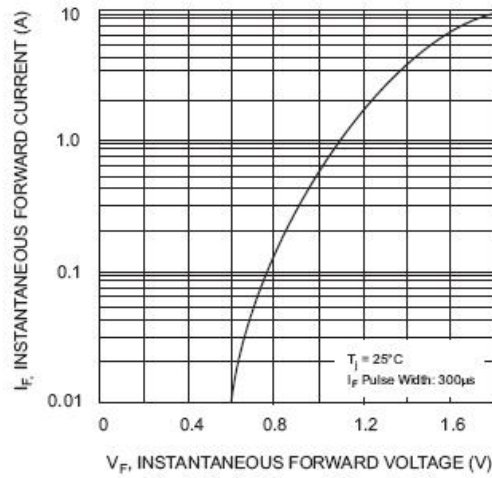

Fig. 2 Typical Forward Characteristics

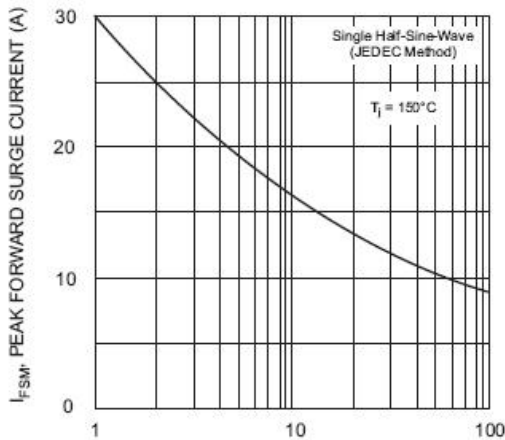

Fig. 3 Forward Surge Current Derating Curve

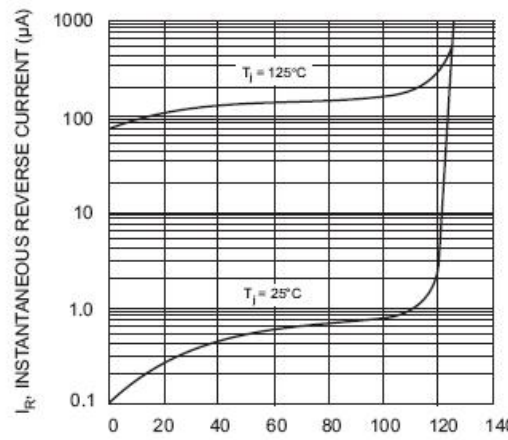
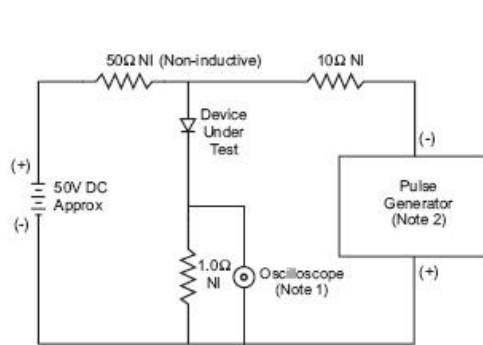

Fig. 4 Typical Reverse Characteristics



Notes:
1. Rise Time = 7.0ns max. Input Impedance = 1.0MΩ, 22pF.
2. Rise Time = 10ns max. Input Impedance = 50Ω.

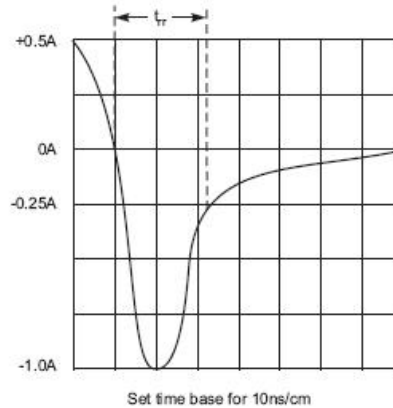
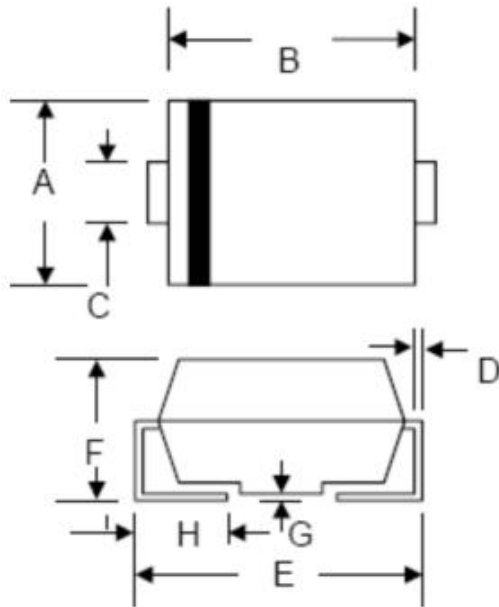

Fig. 5 Reverse Recovery Time Characteristic and Test Circuit

Mechanical Dimensions SMA



SYMBOL	Millimeters		Inches	
	Min.	Max.	Min.	Max.
A	2.40	2.84	0.094	0.112
B	3.99	4.75	0.157	0.187
C	1.05	1.70	0.041	0.067
D	0.15	0.51	0.006	0.020
E	4.80	5.66	0.189	0.223
F	1.90	2.95	0.075	0.116
G	0.05	0.203	0.002	0.008
H	0.76	1.52	0.030	0.600

Ordering Information

Device	Package	Shipping
RS1A-RS1M	SMA (Pb-Free)	5000pcs / reel

For information on tape and reel specifications, including part orientation and tape sizes, please refer to our tape and reel packaging specification.

Marking Diagram



Where XXXXX is YYWWL

RS1A = Type Number
YY = Year
WW = Week
L = Lot Number

Cautions: Molding resin
Epoxy resin UL:94V-0

Carrier Tape Specification SMA

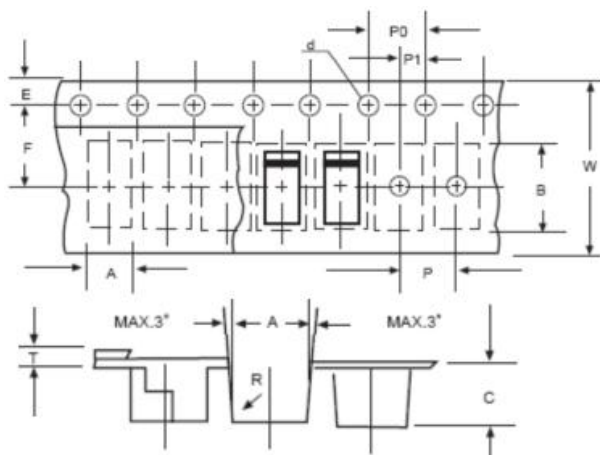

SYMBOL	Millimeters	
	Min.	Max.
A	2.97	3.17
B	5.70	5.90
C	2.32	2.52
d	1.40	1.60
E	1.40	1.60
F	5.60	5.70
P	3.90	4.10
P0	3.90	4.10
P1	1.90	2.10
T	0.25	0.35
W	11.80	12.20

DISCLAIMER:

1- The information given herein, including the specifications and dimensions, is subject to change without prior notice to improve product characteristics. Before ordering, purchasers are advised to contact the SMC - Sangdest Microelectronics (Nanjing) Co., Ltd sales department for the latest version of the datasheet(s).

2- In cases where extremely high reliability is required (such as use in nuclear power control, aerospace and aviation, traffic equipment, medical equipment, and safety equipment), safety should be ensured by using semiconductor devices that feature assured safety or by means of users' fail-safe precautions or other arrangement.

3- In no event shall SMC - Sangdest Microelectronics (Nanjing) Co., Ltd be liable for any damages that may result from an accident or any other cause during operation of the user's units according to the datasheet(s). SMC - Sangdest Microelectronics (Nanjing) Co., Ltd assumes no responsibility for any intellectual property claims or any other problems that may result from applications of information, products or circuits described in the datasheets.

4- In no event shall SMC - Sangdest Microelectronics (Nanjing) Co., Ltd be liable for any failure in a semiconductor device or any secondary damage resulting from use at a value exceeding the absolute maximum rating.

5- No license is granted by the datasheet(s) under any patents or other rights of any third party or SMC - Sangdest Microelectronics (Nanjing) Co., Ltd.

6- The datasheet(s) may not be reproduced or duplicated, in any form, in whole or part, without the expressed written permission of SMC - Sangdest Microelectronics (Nanjing) Co., Ltd.

7- The products (technologies) described in the datasheet(s) are not to be provided to any party whose purpose in their application will hinder maintenance of international peace and safety nor are they to be applied to that purpose by their direct purchasers or any third party. When exporting these products (technologies), the necessary procedures are to be taken in accordance with related laws and regulations..