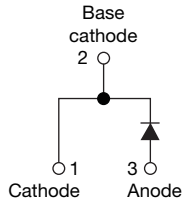

Hyperfast Rectifier, 15 A FRED Pt®

2L TO-220AC

2L TO-220 FULL-PAK

VS-ETX1506-M3

VS-ETX1506FP-M3

FEATURES

- Hyperfast recovery time, extremely low Q_{rr}
- Low forward voltage drop
- 175 °C operating junction temperature
- Low leakage current
- Fully isolated package ($V_{INS} = 2500 V_{RMS}$)
- True 2 pin package
- Designed and qualified according to JEDEC®-JESD 47
- Material categorization: for definitions of compliance please see www.vishay.com/doc?99912

RoHS
 COMPLIANT
 HALOGEN
FREE

DESCRIPTION / APPLICATIONS

State of the art hyperfast recovery rectifiers designed with optimized performance of forward voltage drop, hyperfast recovery time, and soft recovery.

The planar structure and the platinum doped life time control guarantee the best overall performance, ruggedness and reliability characteristics.

These devices are intended for use in PFC boost stage in the AC/DC section of SMPS, inverters or as freewheeling diodes.

The extremely optimized stored charge and low recovery current minimize the switching losses and reduce over dissipation in the switching element and snubbers.

PRODUCT SUMMARY

Package	2L TO-220AC, 2L TO-220FP
$I_{F(AV)}$	15 A
V_R	600 V
V_F at I_F	1.55 V
t_{rr} (typ.)	18 ns
T_J max.	175 °C
Diode variation	Single die

ABSOLUTE MAXIMUM RATINGS

PARAMETER	SYMBOL	TEST CONDITIONS	VALUES	UNITS
Peak repetitive reverse voltage	V_{RRM}		600	V
Average rectified forward current in DC	$I_{F(AV)}$	$T_C = 141\text{ °C}$	15	A
FULL-PAK		$T_C = 71\text{ °C}$		
Non-repetitive peak surge current	I_{FSM}	$T_J = 25\text{ °C}$	120	
Operating junction and storage temperatures	T_J, T_{Stg}		-65 to +175	°C

ELECTRICAL SPECIFICATIONS ($T_J = 25\text{ °C}$ unless otherwise specified)

PARAMETER	SYMBOL	TEST CONDITIONS	MIN.	TYP.	MAX.	UNITS
Breakdown voltage, blocking voltage	V_{BR}, V_R	$I_R = 100\text{ }\mu\text{A}$	600	-	-	V
Forward voltage	V_F	$I_F = 15\text{ A}$	-	2.5	3.4	
		$I_F = 15\text{ A}, T_J = 150\text{ °C}$	-	1.55	2	
Reverse leakage current	I_R	$V_R = V_R$ rated	-	0.02	36	μA
		$T_J = 150\text{ °C}, V_R = V_R$ rated	-	40	250	
Junction capacitance	C_T	$V_R = 600\text{ V}$	-	12	-	pF
Series inductance	L_S	Measured lead to lead 5 mm from package body	-	8	-	nH



DYNAMIC RECOVERY CHARACTERISTICS ($T_J = 25\text{ }^\circ\text{C}$ unless otherwise specified)							
PARAMETER	SYMBOL	TEST CONDITIONS	MIN.	TYP.	MAX.	UNITS	
Reverse recovery time	t_{rr}	$I_F = 1\text{ A}$, $di_F/dt = 100\text{ A}/\mu\text{s}$, $V_R = 30\text{ V}$	-	17	23	ns	
		$I_F = 15\text{ A}$, $di_F/dt = 100\text{ A}/\mu\text{s}$, $V_R = 30\text{ V}$	-	18	30		
		$T_J = 25\text{ }^\circ\text{C}$	-	20	-		
		$T_J = 125\text{ }^\circ\text{C}$	-	45	-		
Peak recovery current	I_{RRM}	$I_F = 15\text{ A}$ $di_F/dt = 200\text{ A}/\mu\text{s}$ $V_R = 390\text{ V}$	$T_J = 25\text{ }^\circ\text{C}$	-	2.7	-	A
			$T_J = 125\text{ }^\circ\text{C}$	-	5.5	-	
Reverse recovery charge	Q_{rr}	$T_J = 25\text{ }^\circ\text{C}$	$T_J = 25\text{ }^\circ\text{C}$	-	26	-	nC
			$T_J = 125\text{ }^\circ\text{C}$	-	130	-	
Reverse recovery time	t_{rr}	$T_J = 125\text{ }^\circ\text{C}$	$I_F = 15\text{ A}$ $di_F/dt = 800\text{ A}/\mu\text{s}$ $V_R = 390\text{ V}$	-	32	-	ns
Peak recovery current	I_{RRM}			-	17	-	A
Reverse recovery charge	Q_{rr}			-	290	-	nC

THERMAL - MECHANICAL SPECIFICATIONS						
PARAMETER	SYMBOL	TEST CONDITIONS	MIN.	TYP.	MAX.	UNITS
Maximum junction and storage temperature range	T_J, T_{Stg}		-65	-	175	$^\circ\text{C}$
Thermal resistance, junction to case FULL-PAK	R_{thJC}		-	1.2	1.4	$^\circ\text{C}/\text{W}$
			-	3.7	4.3	
Thermal resistance, junction to ambient	R_{thJA}	Typical socket mount	-	-	70	
Typical thermal resistance, case to heatsink	R_{thCS}	Mounting surface, flat, smooth and greased	-	0.5	-	
Weight			-	2	-	g
			-	0.07	-	oz.
Mounting torque			6 (5)	-	12 (10)	kgf · cm (lbf · in)
Marking device		Case style 2L TO-220AC	ETX1506			
		Case style 2L TO-220 FULL-PAK	ETX1506FP			

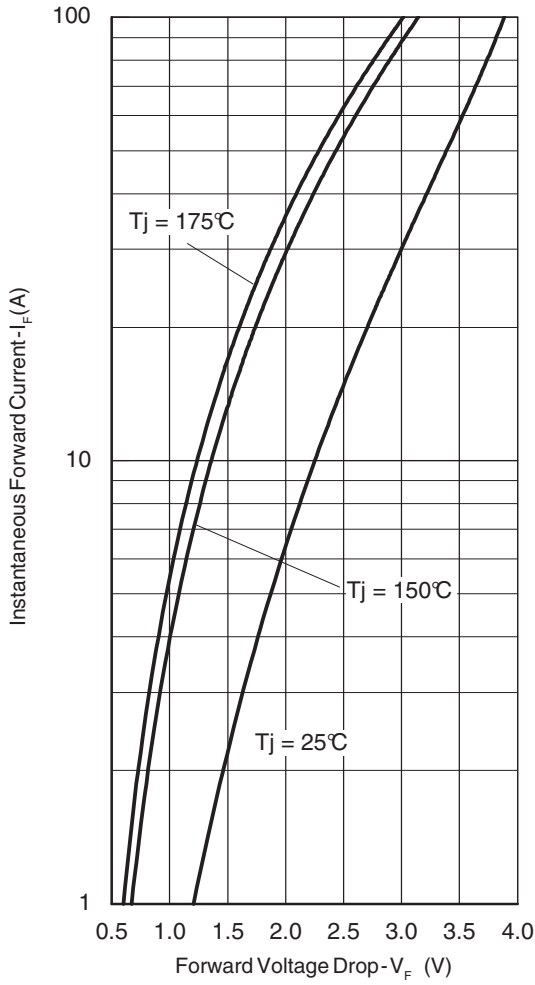

Fig. 1 - Typical Forward Voltage Drop Characteristics

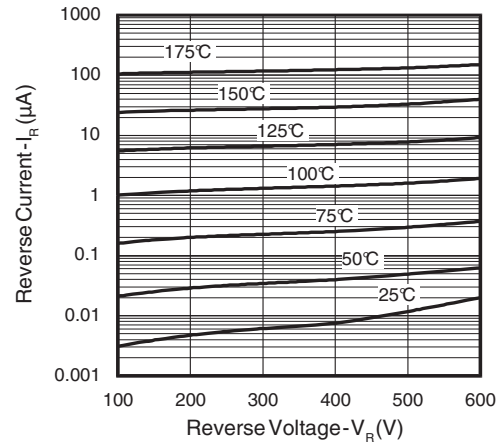

Fig. 2 - Typical Values of Reverse Current vs. Reverse Voltage

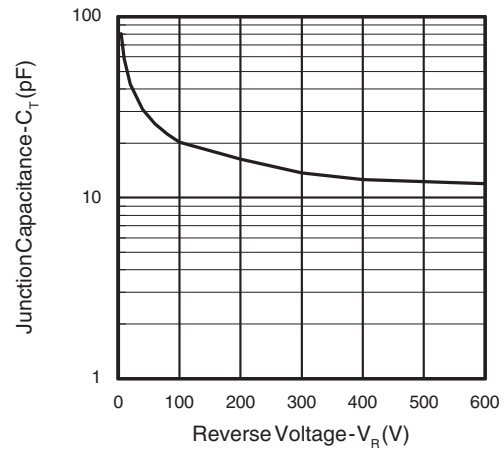

Fig. 3 - Typical Junction Capacitance vs. Reverse Voltage

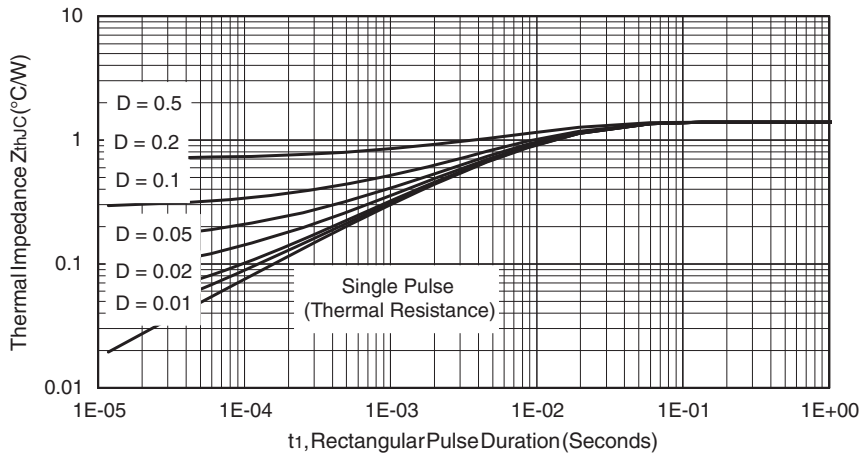

Fig. 4 - Maximum Thermal Impedance Z_{ThJC} Characteristics

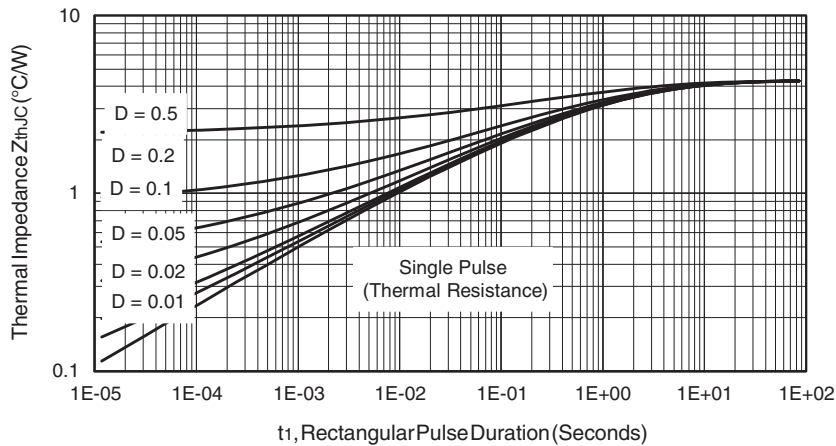

Fig. 5 - Maximum Thermal Impedance Z_{thJC} Characteristics (FULL-PAK)

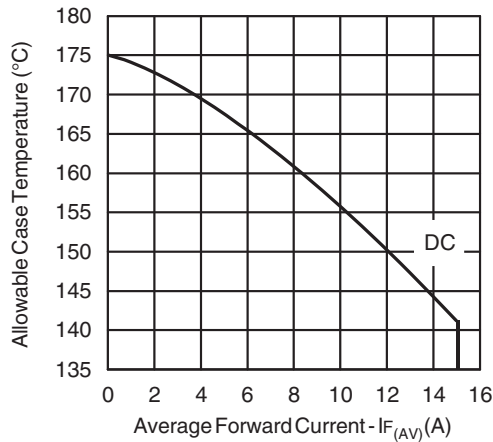

Fig. 6 - Maximum Allowable Case Temperature vs. Average Forward Current

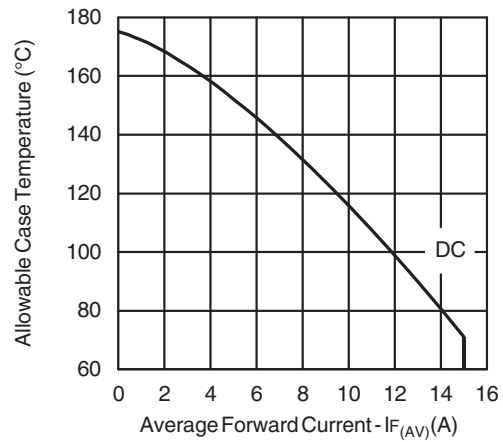

Fig. 7 - Maximum Allowable Case Temperature vs. Average Forward Current (FULL-PAK)

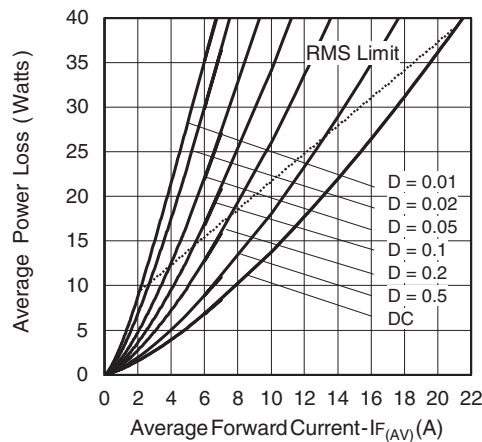

Fig. 8 - Forward Power Loss Characteristics

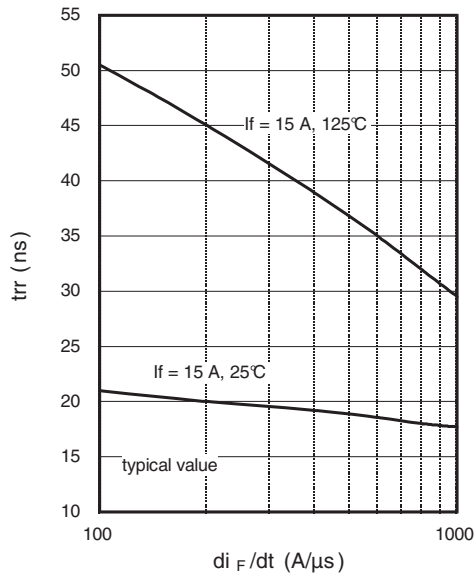

Fig. 9 - Typical Reverse Recovery vs. di_F/dt

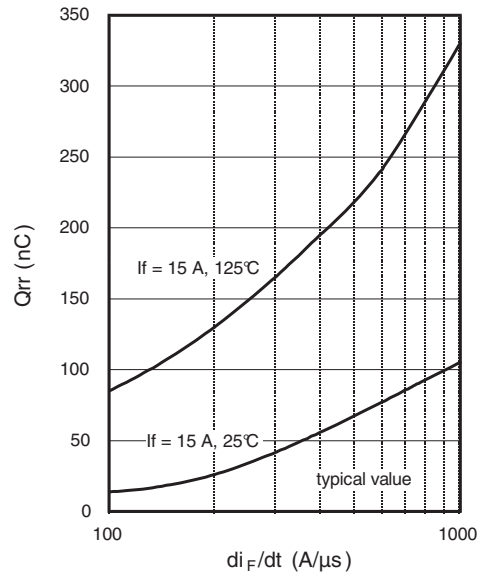

Fig. 10 - Typical Stored Charge vs. di_F/dt

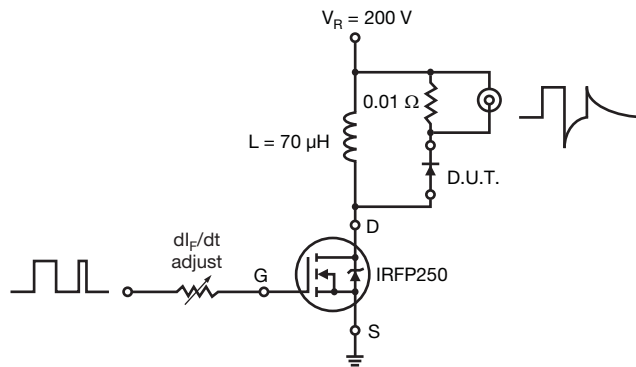
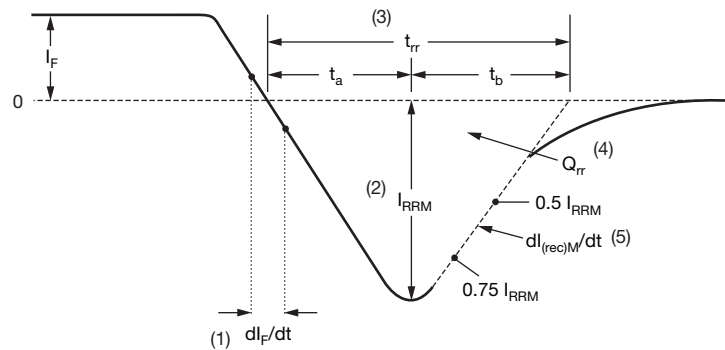

Fig. 11 - Reverse Recovery Parameter Test Circuit



- (1) di_F/dt - rate of change of current through zero crossing
- (2) I_{RRM} - peak reverse recovery current
- (3) t_{rr} - reverse recovery time measured from zero crossing point of negative going I_F to point where a line passing through $0.75 I_{RRM}$ and $0.50 I_{RRM}$ extrapolated to zero current.
- (4) Q_{rr} - area under curve defined by t_{rr} and I_{RRM}
- (5) $dl_{(rec)M}/dt$ - peak rate of change of current during t_b portion of t_{rr}

$$Q_{rr} = \frac{t_{rr} \times I_{RRM}}{2}$$

Fig. 12 - Reverse Recovery Waveform and Definitions



ORDERING INFORMATION TABLE

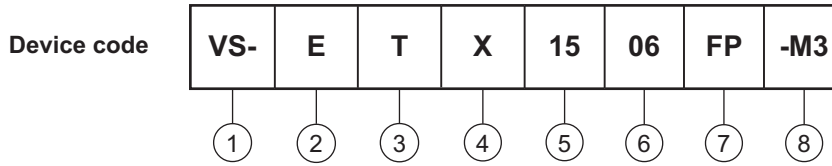

- 1** - Vishay Semiconductors product
- 2** - Circuit configuration:
E = single diode
- 3** - T = TO-220
- 4** - X = hyperfast recovery time
- 5** - Current code: 15 = 15 A
- 6** - Voltage code: 06 = 600 V
- 7** -
 - None = TO-220
 - FP = FULL-PAK
- 8** - Environmental digit:
-M3 = halogen-free, RoHS-compliant and terminations lead (Pb)-free

ORDERING INFORMATION (Example)			
PREFERRED P/N	QUANTITY PER TUBE	MINIMUM ORDER QUANTITY	PACKAGING DESCRIPTION
VS-ETX1506-M3	50	1000	Antistatic plastic tube
VS-ETX1506FP-M3	50	1000	Antistatic plastic tube

LINKS TO RELATED DOCUMENTS			
Dimensions	2L TO-220AC	www.vishay.com/doc?95259	
	2L TO-220 FULL-PAK	www.vishay.com/doc?95260	
Part marking information	2L TO-220AC	www.vishay.com/doc?95391	
	2L TO-220 FULL-PAK	www.vishay.com/doc?95392	

True 2 Pin TO-220

DIMENSIONS in millimeters and inches



SYMBOL	MILLIMETERS		INCHES	
	MIN.	MAX.	MIN.	MAX.
A	4.32	4.57	0.170	0.180
b	0.71	0.91	0.028	0.036
b ₁	1.15	1.39	0.045	0.055
c	0.36	0.53	0.014	0.021
D	14.99	15.49	0.590	0.610
E	10.04	10.41	0.395	0.410
e	5.08 BSC		0.200 BSC	
F	1.22	1.37	0.048	0.054
H ₁	5.97	6.47	0.235	0.255
J ₁	2.54	2.79	0.100	0.110
L	13.47	13.97	0.530	0.550
L ₁ ⁽¹⁾	3.31	3.81	0.130	0.150
Ø P	3.79	3.88	0.149	0.153
Q	2.60	2.84	0.102	0.112

Notes

⁽¹⁾ Lead dimension and finish uncontrolled in L₁

- These dimensions are within allowable dimensions of JEDEC TO-220AB rev. J outline dated 3-24-87
- Controlling dimension: Inch



True 2 Pin TO-220 FULL-PAK

DIMENSIONS in millimeters and inches



SYMBOL	MILLIMETERS		INCHES	
	MIN.	MAX.	MIN.	MAX.
A	4.53	4.93	0.178	0.194
b	0.71	0.91	0.028	0.036
b_1	1.15	1.39	0.045	0.055
C	0.36	0.53	0.014	0.021
D	15.67	16.07	0.617	0.633
E	9.96	10.36	0.392	0.408
e	5.08 typical		0.200 typical	
F	2.34	2.74	0.092	0.107
H_1	6.50	6.90	0.256	0.272
J_1	2.56	2.96	0.101	0.117
L	12.78	13.18	0.503	0.519
L_1	2.23	2.63	0.088	0.104
$\varnothing Q$	2.98	3.38	0.117	0.133
Q_1	3.10	3.50	0.122	0.138
Q_2	14.80	15.20	0.583	0.598
θ	0°	5°	0°	5°



Disclaimer

ALL PRODUCT, PRODUCT SPECIFICATIONS AND DATA ARE SUBJECT TO CHANGE WITHOUT NOTICE TO IMPROVE RELIABILITY, FUNCTION OR DESIGN OR OTHERWISE.

Vishay Intertechnology, Inc., its affiliates, agents, and employees, and all persons acting on its or their behalf (collectively, "Vishay"), disclaim any and all liability for any errors, inaccuracies or incompleteness contained in any datasheet or in any other disclosure relating to any product.

Vishay makes no warranty, representation or guarantee regarding the suitability of the products for any particular purpose or the continuing production of any product. To the maximum extent permitted by applicable law, Vishay disclaims (i) any and all liability arising out of the application or use of any product, (ii) any and all liability, including without limitation special, consequential or incidental damages, and (iii) any and all implied warranties, including warranties of fitness for particular purpose, non-infringement and merchantability.

Statements regarding the suitability of products for certain types of applications are based on Vishay's knowledge of typical requirements that are often placed on Vishay products in generic applications. Such statements are not binding statements about the suitability of products for a particular application. It is the customer's responsibility to validate that a particular product with the properties described in the product specification is suitable for use in a particular application. Parameters provided in datasheets and / or specifications may vary in different applications and performance may vary over time. All operating parameters, including typical parameters, must be validated for each customer application by the customer's technical experts. Product specifications do not expand or otherwise modify Vishay's terms and conditions of purchase, including but not limited to the warranty expressed therein.

Except as expressly indicated in writing, Vishay products are not designed for use in medical, life-saving, or life-sustaining applications or for any other application in which the failure of the Vishay product could result in personal injury or death. Customers using or selling Vishay products not expressly indicated for use in such applications do so at their own risk. Please contact authorized Vishay personnel to obtain written terms and conditions regarding products designed for such applications.

No license, express or implied, by estoppel or otherwise, to any intellectual property rights is granted by this document or by any conduct of Vishay. Product names and markings noted herein may be trademarks of their respective owners.