

Analog Devices Welcomes Hittite Microwave Corporation

NO CONTENT ON THE ATTACHED DOCUMENT HAS CHANGED



THIS PAGE INTENTIONALLY LEFT BLANK



GaAs MMIC 6-BIT DIGITAL PHASE SHIFTER, 9 - 12.5 GHz

Typical Applications

The HMC642LC5 is ideal for:

- EW Receivers
- Weather & Military Radar
- Satellite Communications
- Beamforming Modules
- Phase Cancellation

Features

- Low RMS Phase Error: 3.5°
- Low Insertion Loss: 7 dB
- High Linearity: +41 dBm
- Positive Control Logic
- 360° Coverage, LSB = 5.625°
- 32 Lead Ceramic SMT Package: 25mm²

Functional Diagram

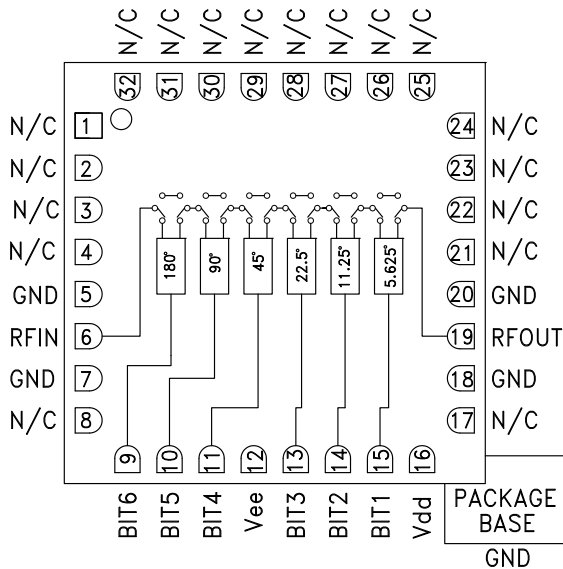

General Description

The HMC642LC5 is a 6-bit digital phase shifter which is rated from 9 to 12.5 GHz, providing 360 degrees of phase coverage, with a LSB of 5.625 degrees. The HMC642LC5 features very low RMS phase error of 3.5 degrees and extremely low insertion loss variation of ±0.4 dB across all phase states. This high accuracy phase shifter is controlled with positive control logic of 0/+5V. The HMC642LC5 is housed in a compact 5x5 mm ceramic leadless SMT package and is internally matched to 50 Ohms with no external components.

Electrical Specifications

$T_A = +25^\circ C$, $V_{SS} = -5V$, $V_{DD} = +5V$, Control Voltage = 0/ +5V, 50 Ohm System

Parameter	Min.	Typ.	Max.	Units
Frequency Range	9		12.5	GHz
Insertion Loss*		7	10	dB
Input Return Loss*		14		dB
Output Return Loss*		11		dB
Phase Error*		±10	+15 / -10	deg
RMS Phase Error		3.5		deg
Insertion Loss Variation*		±0.4		dB
Input Power for 1 dB Compression		28		dBm
Input Third Order Intercept		41		dBm
Control Voltage Current		<250		µA
Bias Control Current		<12		mA

*Note: Major States Shown

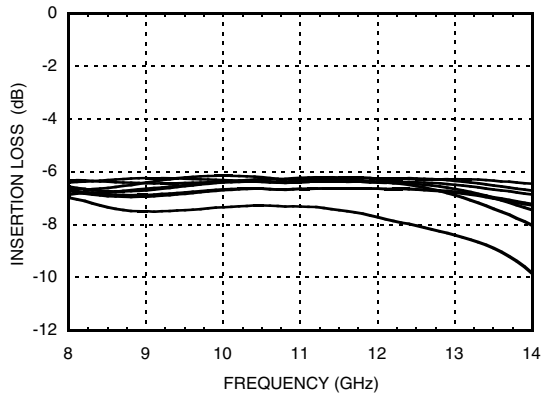
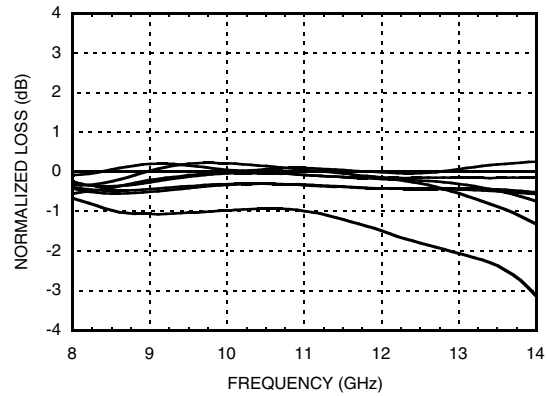
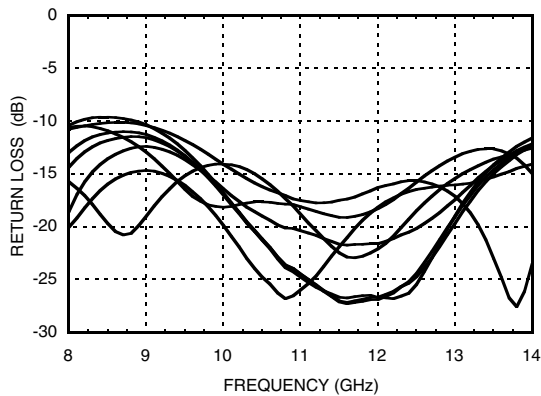
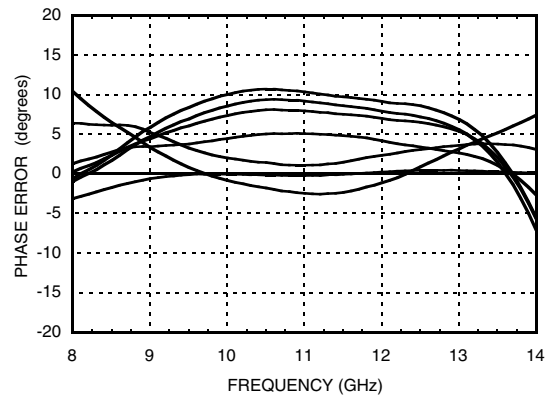
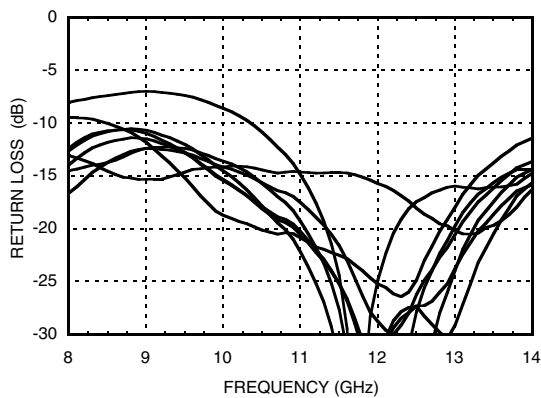
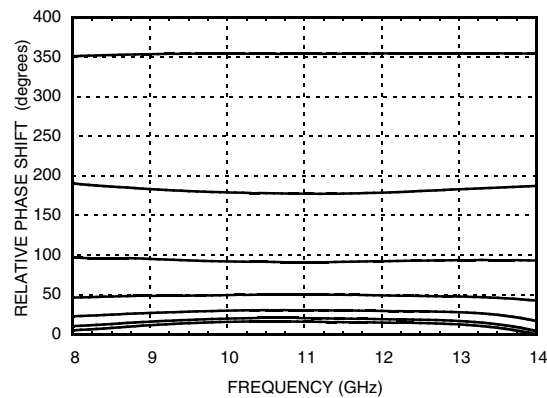
**GaAs MMIC 6-BIT DIGITAL
PHASE SHIFTER, 9 - 12.5 GHz**
Insertion Loss, Major States Only

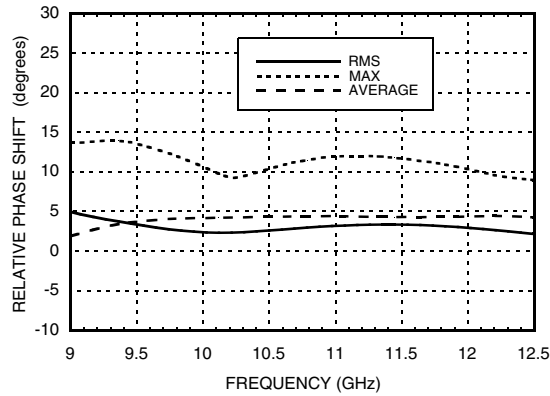
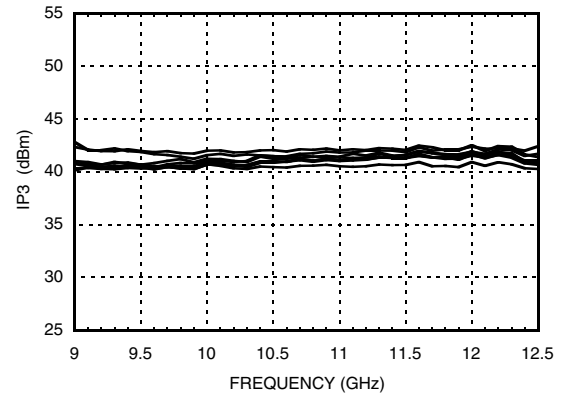
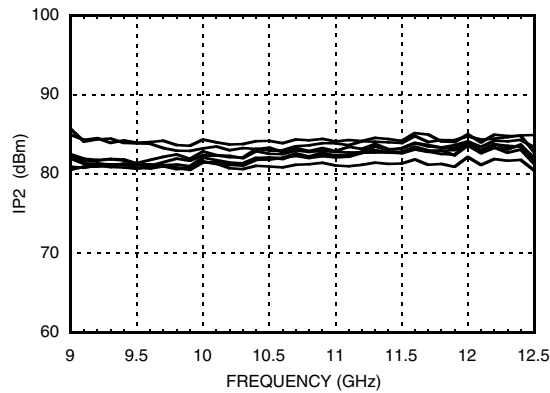
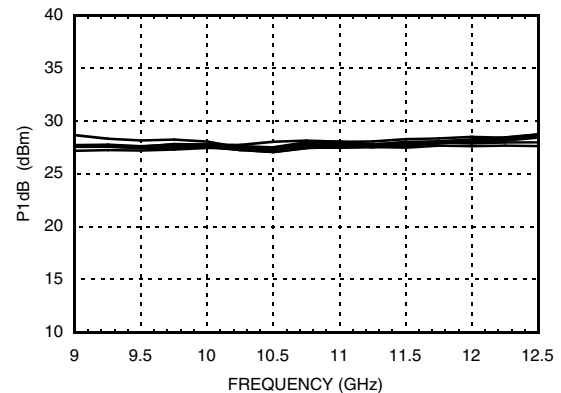
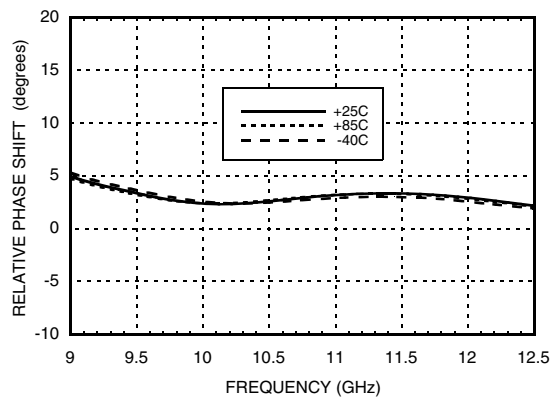
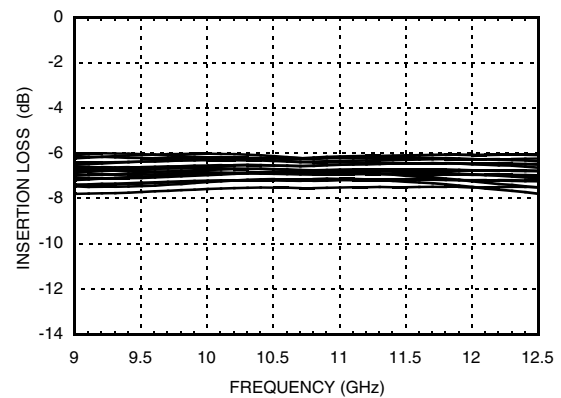
Normalized Loss, Major States Only

Input Return Loss, Major States Only

Phase Error, Major States Only

Output Return Loss, Major States Only

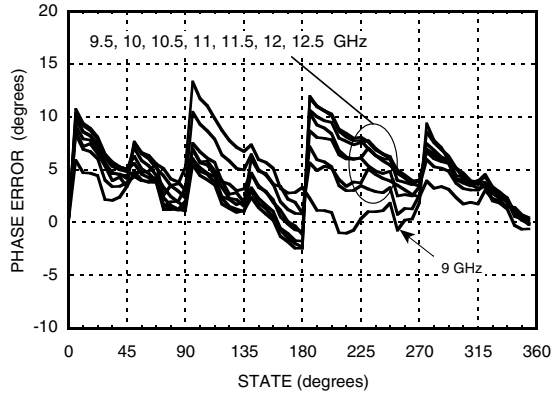
**Relative Phase Shift
Major States Including All Bits**



GaAs MMIC 6-BIT DIGITAL PHASE SHIFTER, 9 - 12.5 GHz
Relative Phase Shift, RMS, Average, Max, All States

Input IP3, Major States Only

Input IP2, Major States Only

Input P1dB, Major States Only

RMS Phase Error vs. Temperature

Insertion Loss vs. Temperature, Major States Only



GaAs MMIC 6-BIT DIGITAL PHASE SHIFTER, 9 - 12.5 GHz

Phase Error vs. State



Bias Voltage & Current

Vdd	Idd
5.0	5.6mA
Vss	Iss
-5.0	5.6mA

Control Voltage

State	Bias Condition
Low (0)	0 to 0.2 Vdc
High (1)	Vdd ±0.2 Vdc @ 35 µA Typ.

Absolute Maximum Ratings

Input Power (RFIN)	29 dBm (T= +85 °C)
Bias Voltage Range (Vdd)	-0.2 to +12V
Bias Voltage Range (Vss)	+0.2 to -12V
Channel Temperature (Tc)	150 °C
Thermal Resistance (channel to ground paddle)	80 °C/W
Storage Temperature	-65 to +150 °C
Operating Temperature	-40 to +85 °C



ELECTROSTATIC SENSITIVE DEVICE
OBSERVE HANDLING PRECAUTIONS

Truth Table

Control Voltage Input						Phase Shift (Degrees) RFIN - RFOUT
Bit 1	Bit 2	Bit 3	Bit 4	Bit 5	Bit 6	
0	0	0	0	0	0	Reference*
1	0	0	0	0	0	5.625
0	1	0	0	0	0	11.25
0	0	1	0	0	0	22.5
0	0	0	1	0	0	45.0
0	0	0	0	1	0	90.0
0	0	0	0	0	1	180.0
1	1	1	1	1	1	354.375

Any combination of the above states will provide a phase shift approximately equal to the sum of the bits selected.
*Reference corresponds to monotonic setting

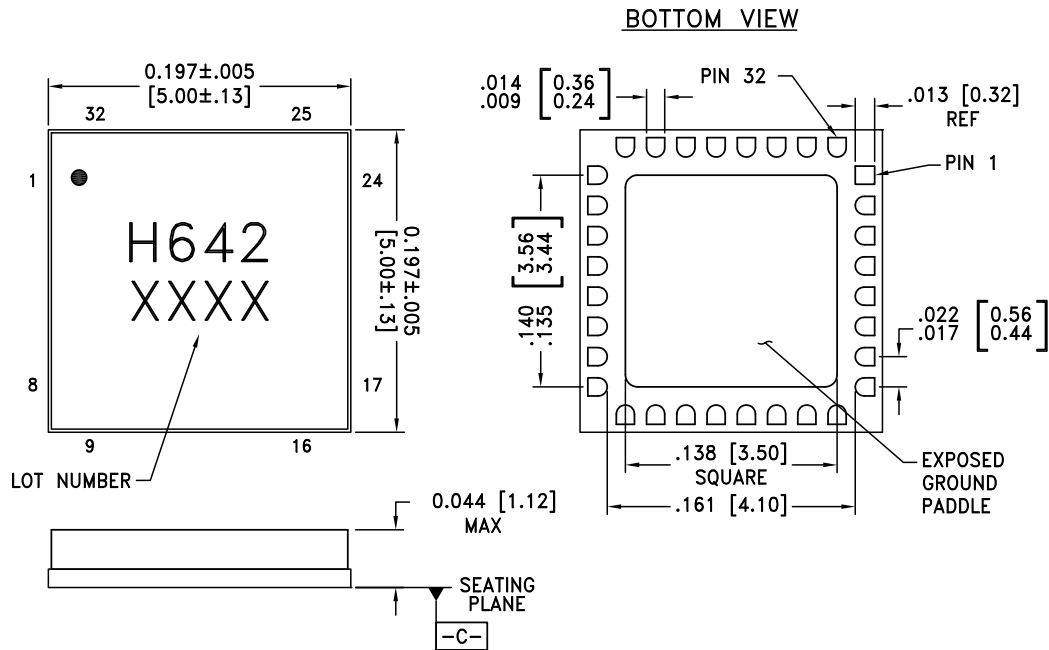
Outline Drawing

NOTES:

1. PACKAGE BODY MATERIAL: ALUMINA
2. LEAD AND GROUND PADDLE PLATING: 30-80 MICROINCHES GOLD OVER 50 MICROINCHES MINIMUM NICKEL.
3. DIMENSIONS ARE IN INCHES [MILLIMETERS].
4. LEAD SPACING TOLERANCE IS NON-CUMULATIVE
5. PACKAGE WARP SHALL NOT EXCEED 0.05mm DATUM [-C-]
6. ALL GROUND LEADS AND GROUND PADDLE MUST BE SOLDERED TO PCB RF GROUND.



Package Information

Part Number	Package Body Material	Lead Finish	MSL Rating	Package Marking ^[2]
HMC642LC5	Alumina, White	Gold over Nickel	MSL3 ^[1]	H642 XXXX

[1] Max peak reflow temperature of 260 °C

[2] 4-Digit lot number XXXX

Pin Descriptions

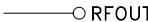
Pin Number	Function	Description	Interface Schematic
1 - 4, 8, 17 21 - 32	N/C	No connection required. These pins may be connected to RF/DC ground without affecting performance.	
5, 7, 18, 20	GND	These pins and exposed ground paddle must be connected to RF/DC ground.	
6	RFIN	This port is DC coupled and matched to 50 Ohms.	
9 - 11, 13 - 15	BIT6, BIT5, BIT4, BIT3, BIT2, BIT1	Control Input. See truth table and control voltage tables.	
12	Vss	Voltage supply.	
16	Vdd	Voltage supply.	
19	RFOUT	This port is DC coupled and matched to 50 Ohms.	

Evaluation PCB

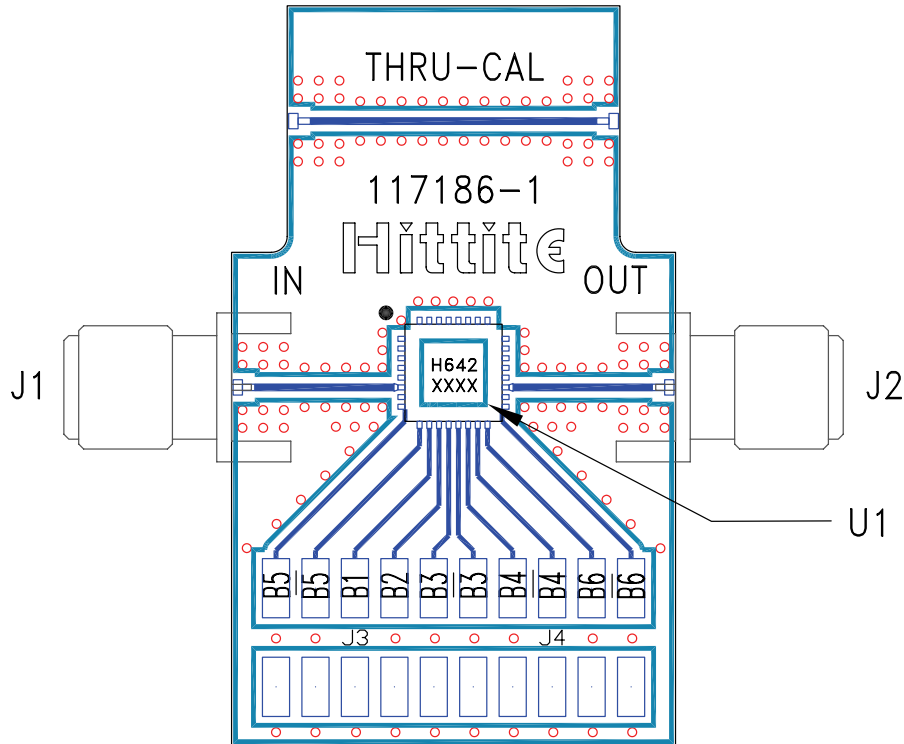

List of Materials for Evaluation PCB 117252 ^{[1][3]}

Item	Description
J1 - J2	PCB Mount SMA RF Connector
J3 - J4	Molex Header 2mm
U1	HMC642LC5 6-Bit Digital Phase Shifter
PCB [2]	117186 Evaluation PCB

[1] Reference this number when ordering complete evaluation PCB

[2] Circuit Board Material: Rogers 4350

[3] Please refer to part's pin description and functional diagram for pin out assignments on evaluation board.

The circuit board used in the final application should use RF circuit design techniques. Signal lines should have 50 ohm impedance while the package ground leads and exposed paddle should be connected directly to the ground plane similar to that shown. A sufficient number of via holes should be used to connect the top and bottom ground planes. The evaluation board should be mounted to an appropriate heat sink. The evaluation circuit board shown is available from Hittite upon request.



**GaAs MMIC 6-BIT DIGITAL
PHASE SHIFTER, 9 - 12.5 GHz**