

Photoelectrics

Retro-reflective for Transparent Objects

Type PD30CNG02...MU



- Miniature sensor range
- Range: 2 m, with reflector
- Sensitivity adjustment by Teach-In programming
- Modulated, red light 617 nm
- Supply voltage: 10 to 30 VDC
- Output: 100 mA, NPN or PNP preset
- Make and break switching function programmable
- LED indication for output, stability and power ON
- Protection: reverse polarity, short circuit and transients
- Cable and plug versions
- Excellent EMC performance
- Mute function (sensor blanking)



Product Description

The PD30CNG02 sensor family comes in a compact 10 x 30 x 20 mm reinforced PMMA/ABS housing. The sensors are useful in applications where detection of transparent objects are needed. Compact housing and high power LED for excellent performance-size ratio.

The Teach-In function for adjustment of the sensitivity makes the sensors highly flexible. The output type is preset (NPN or PNP), and the output switching function is programmable (NO or NC). The mute function can be used for testing the sensor for: Malfunctioning, disconnection, optical axis adjustment, dusty and dirty lenses.

Ordering Key **PD30CNG02PPM5MU**

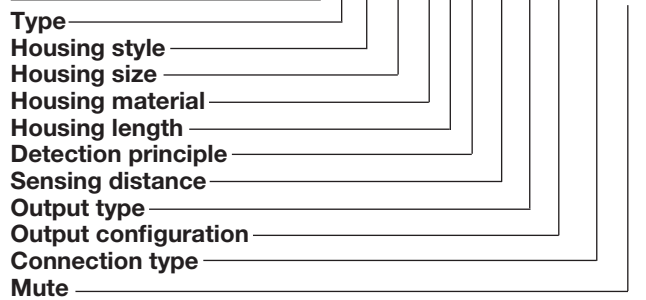

Type Selection

Housing W x H x D	Range S _n	Connection	Ordering no. NPN Make or break switching	Ordering no. PNP Make or break switching
10 x 30 x 20 mm	2 m	Cable	PD 30 CNG 02 NPMU	PD 30 CNG 02 PPMU
10 x 30 x 20 mm	2 m	Plug	PD 30 CNG 02 NPM5MU	PD 30 CNG 02 PPM5MU

Note: Reflectors to be ordered separately

Specifications EN 60947-5-2

Rated operating distance (S_n)	Up to 2 m, with reflector Ø 80 mm (ER4)	Protection	Short-circuit, reverse polarity and transients
Detection reliability	20% attenuation	Light source	inGaAlP, LED, 617 nm
Blind zone	10 mm	Light type, not polarized	Red, modulated
Sensitivity	Adjustable by Teach-In	Sensing angle	± 2°
Temperature drift	≤ 0.1%/°C Teach settings are valid for teach temperature ± 20°C	Ambient light	10,000 lux
Hysteresis (H) (differential travel)	≤ 10%	Light spot	110 mm @ 1.5 m
Rated operational volt. (U_B)	10 to 30 VDC (ripple included)	Operating frequency	1000 Hz
Ripple (U_{ripple})	≤ 10%	Response time	OFF-ON (t _{ON}) ≤ 0.5 ms ON-OFF (t _{OFF}) ≤ 0.5 ms
Output current	≤ 100 mA ≤ 100 mA (max. load capacity 100 nF)	Power ON delay (t_v)	≤ 300 ms
No load supply current (I_o)	≤ 30 mA @ 24 VDC	Output function	NPN and PNP NO/NC switching function Preset Set up by button
Minimum operational current (I_m)	0.5 mA	Mute function	Emitter off 0 to 3 sec 0 to 2.5 VDC (NPN) 5 to 30 VDC (PNP) Not connected
OFF-state current (I_r)	≤ 100 µA	Operating mode	
Voltage drop (U_d)	≤ 2.4 VDC @ 100 mA	Indication	Output ON LED, yellow Signal stability ON and power ON LED, green



Specifications (cont.) EN 60947-5-2

Environment		Rated insulation voltage	500 VAC (rms)
Installation category	III (IEC 60664/60664A; 60947-1)	Housing material	
Pollution degree	3 (IEC 60664/60664A; 60947-1)	Body	ABS
Degree of protection	IP 67 (IEC 60529; 60947-1)	Front material	PMMA, red
Ambient temperature		Connection	
Operating	-25° to +55°C (-13° to +131°F)	Cable	PVC, black, 2 m 4 x 0.14 mm ² , Ø = 3.3 mm M8, 4-pin (CON, 54-series)
Storage	-40° to +70°C (-40° to +158°F)	Plug	
Vibration	10 to 55 Hz, 0.5 mm/7.5 g (IEC 60068-2-6)	Weight	With cable: 40 g With plug: 10 g
Shock	30 g / 11ms, 3 pos, 3 neg per axis (IEC 60068-2-6, 60068-2-32)	CE-marking	Yes
		Approvals	cULus (UL508)

Operation Diagram

tv = Power ON delay

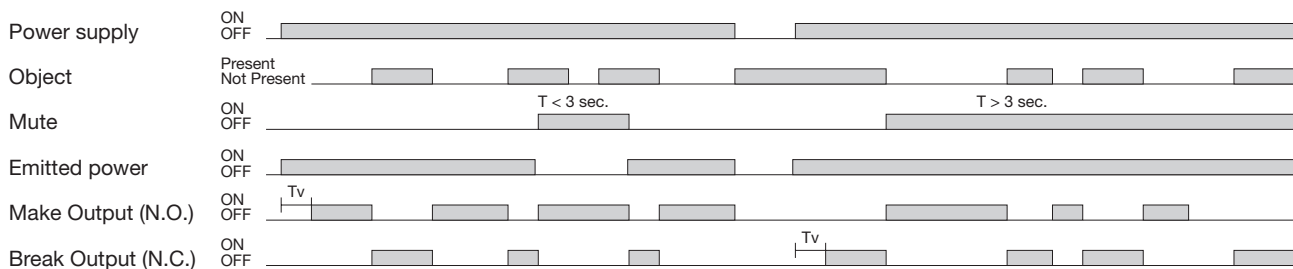

Wiring Diagrams

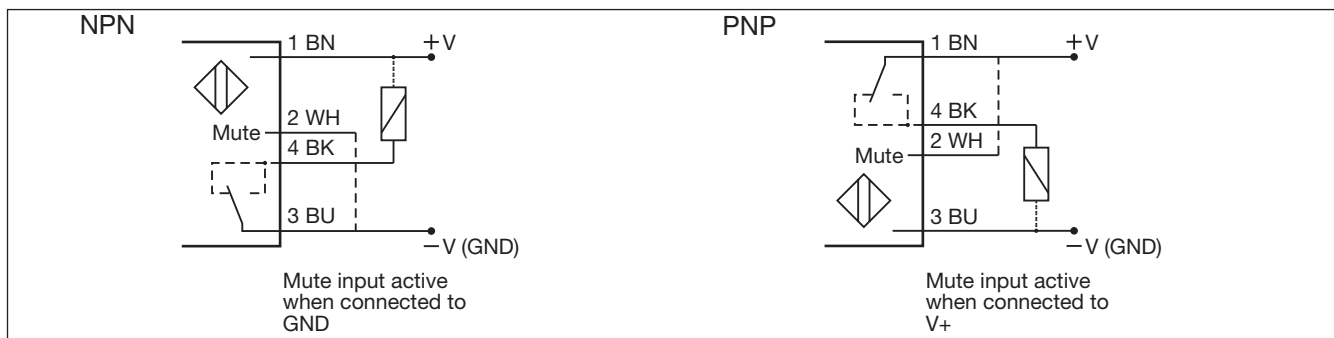

Detection Diagram

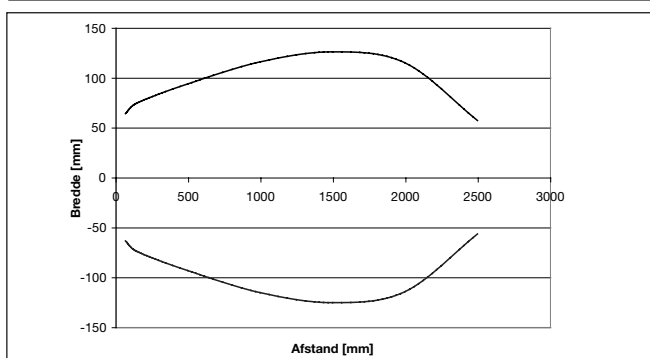

Excess Gain

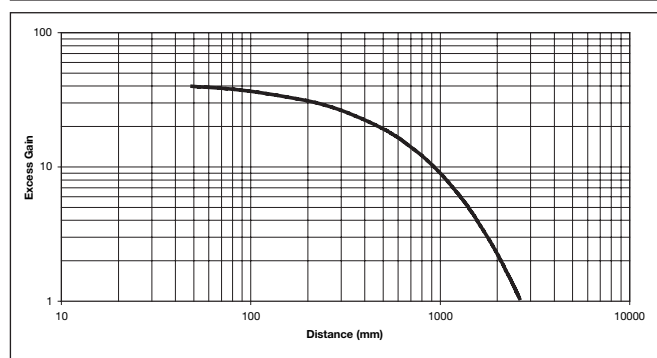

Signal Stability Indication

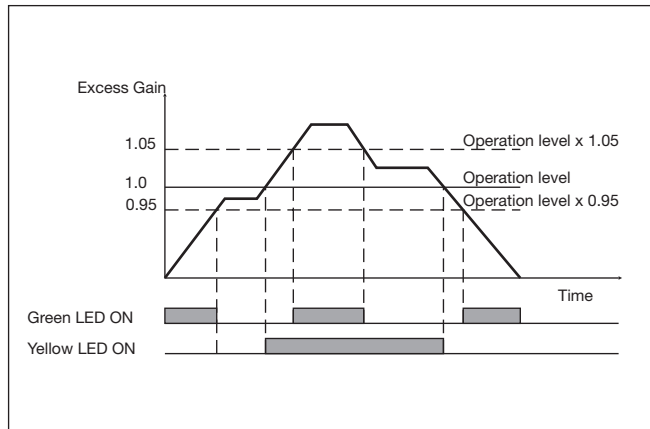

Accessories

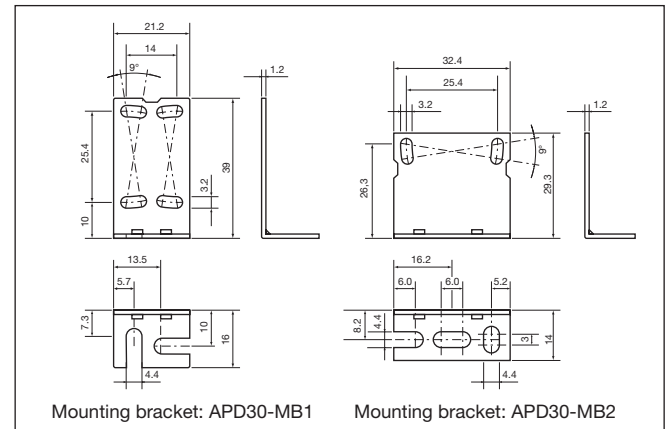

Dimensions

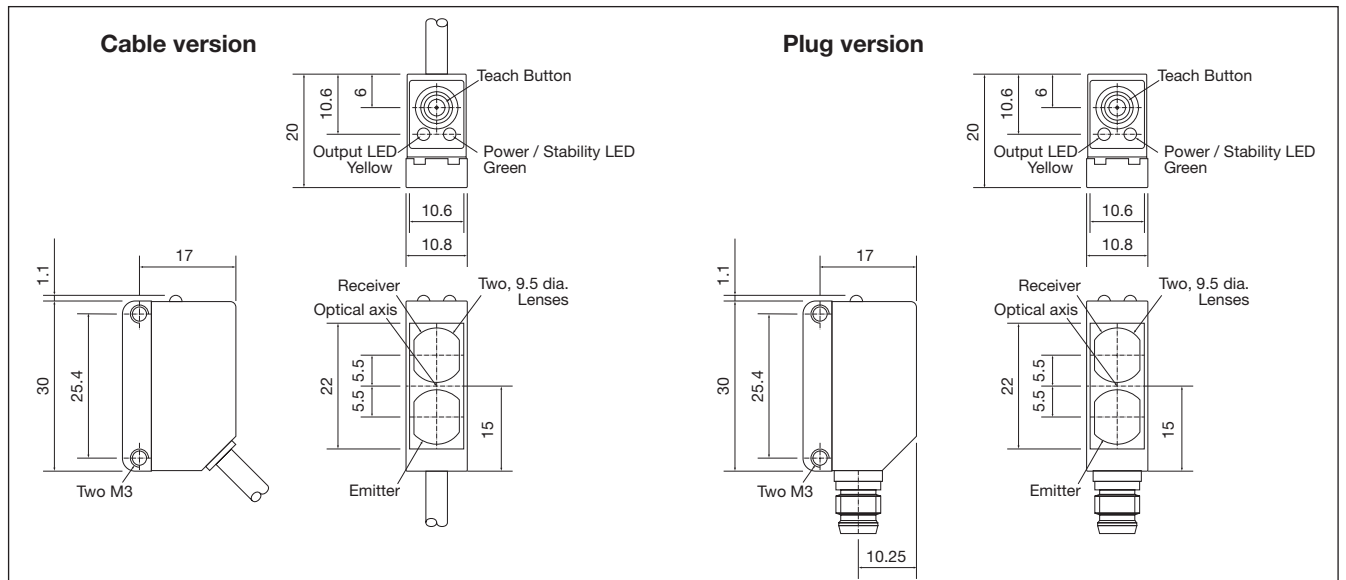

Installation Hints

<p>To avoid interference from inductive voltage / current peaks, separate the proximity switch cables from any other power cables. E.g. Engine, contactor or solenoid cables</p> <p>Incorrect Correct > 100 mm</p>	<p>Relief of the cable strain</p> <p>Incorrect Correct</p> <p>The cable should not be pulled</p>	<p>Protection of the sensing face</p> <p>Incorrect</p> <p>A proximity switch should not serve as mechanical stop</p>	<p>Sensor mounted on a mobile carrier</p> <p>Any repetitive flexing of the cable should be avoided</p>
---	--	--	--

Delivery Contents

- Photoelectric switch: PD 30 CNG 02 ...MU
- Installation instruction
- Mounting bracket APD30-MB1
- **Packaging:** Cardboard box

Accessories

- Mounting bracket APD30-MB2 to be purchased separately

Teach functions

Normal operation, optimized switching point

1. Line up the sensor with the reflector. Yellow LED and Green LED are ON.
2. Press the button for 3 seconds until both LEDs flashes simultaneously.
(The first switch point is stored)
3. Place the object between the sensor and reflector in the detection zone.
4. Press the button once and the sensor is ready to operate (Green LED ON, Yellow LED ON)
(The second switch point is stored)

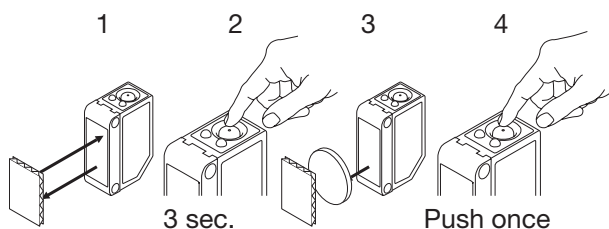

For make or break set-up (N.O. or N.C.)

1. Press the button for 10 seconds, until the green LEDs flashes.
2. While the green LED flashes, the output is inverted each time the button is pressed. Yellow LED indicates N.O. function selected.
If the button is not pressed within the next 10 seconds, the current output is stored.

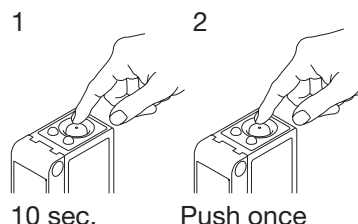

For maximum sensing distance (default setting)

1. Line up the sensor with the reflector, place a new transparent object between the sensor and reflector in the detection zone. Yellow LED is OFF and Green LED is ON.
2. Press the button for 3 seconds until both LEDs flashes simultaneously.
(The first switch point is stored)
3. Press the button a second time and the sensor is ready to operate (Green LED ON, Yellow LED ON)
(The second switch point is stored)

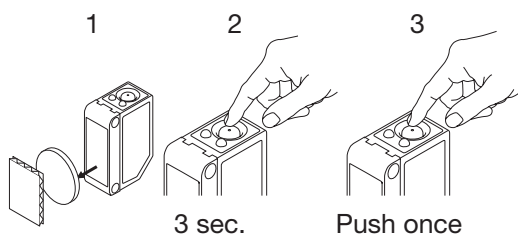

For the most transparent objects

1. Line up the sensor with the reflector. Yellow LED and Green LED are ON.
2. Press the button for 3 seconds until both LEDs flashes simultaneously.
(The first switch point is stored)
3. Press the button a second time and the sensor is ready to operate (Green LED ON, Yellow LED ON)
(The second switch point is stored)

