

ASSEMBLY INSTRUCTIONS:

1. PREPARE CABLE ENDS, CONNECT TO CONNECTOR
2. CLAMP STRAIN RELIEF ONTO CABLE MAKING SURE CABLE JACKET IS BELOW STRAIN RELIEF
3. PLACE STRAIN RELIEF INSIDE STRAIN RELIEF AREA OF ONE HOOD
4. INSERT THE JACKSCREWS IN THE SADDLE WASHERS. PLACE THE JACKSCREWS INTO THE HOOD WITH THE CABLE
5. PLACE THE OTHER HALVE OF THE HOOD ON TOP OF THE FIRST HALF, MAKING SURE NO WIRES ARE PINCHED
6. HOLDING THE HOODS TOGETHER, INSERT THE MOUNTING SCREWS THROUGH THE HOODS IN OPPOSITE DIRECTIONS. TIGHTEN THE TWO HALVES TOGETHER

9, 15, 25 & 37 PIN

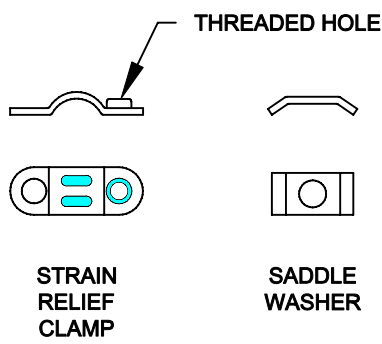
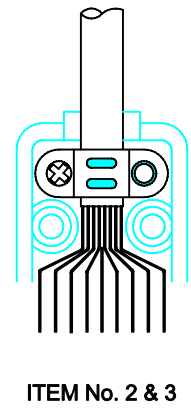
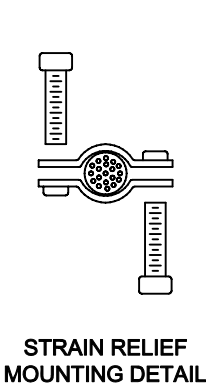
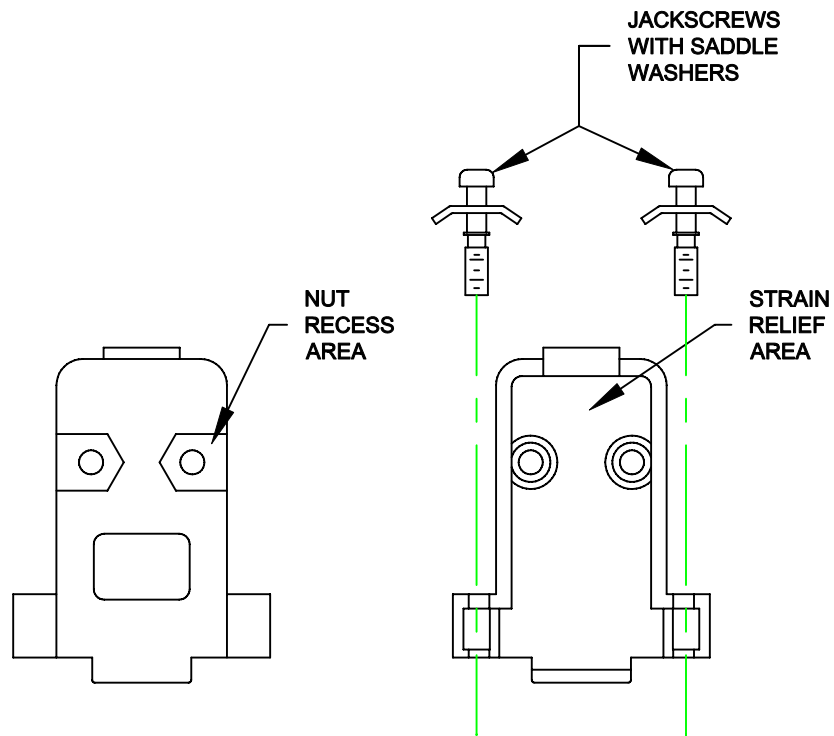

RoHS COMPLIANT

PLASTIC

	THESE DRAWINGS AND SPECIFICATIONS ARE THE PROPERTY OF NorComp AND SHALL NOT BE REPRODUCED, COPIED OR USED AS THE BASIS FOR THE MANUFACTURE OF SALE OF APPARATUS WITHOUT WRITTEN PERMISSION.		DRAWN: C. SMITH	DATE: 03-29-06
			CHECKED: X	DATE: X
<h1>NorComp</h1>		SCALE: N.T.S.	SHEET 1	OF 4
		REV 0		
		DWG NO. BACKSHELL - 977 SERIES		

ASSEMBLY INSTRUCTIONS:

1. PREPARE CABLE ENDS, CONNECT TO CONNECTOR
2. CLAMP STRAIN RELIEF ONTO CABLE MAKING SURE CABLE JACKET IS BELOW STRAIN RELIEF
3. IF CABLE IS SHIELDED, FOLD SHIELD AND/OR GROUND WIRE BACK UNDER STRAIN RELIEF BEFORE CLAMPING. CUT ANY EXCESS WIRE FLUSH WITH THE TOP OF THE STRAIN RELIEF
4. PLACE STRAIN RELIEF INSIDE STRAIN RELIEF AREA OF ONE HOOD
5. INSERT THE JACKSCREWS IN THE SADDLE WASHERS. PLACE THE JACKSCREWS INTO THE HOOD WITH THE CABLE
6. PLACE THE OTHER HALVE OF THE HOOD ON TOP OF THE FIRST HALF, MAKING SURE NO WIRES ARE PINCHED
7. HOLDING THE HOODS TOGETHER, INSERT THE MOUNTING SCREWS THROUGH THE HOODS IN OPPOSITE DIRECTIONS. TIGHTEN THE TWO HALVES TOGETHER

9, 15, 25 & 37 PIN

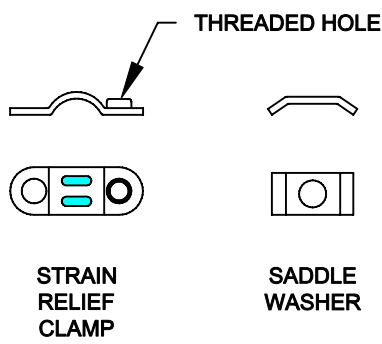
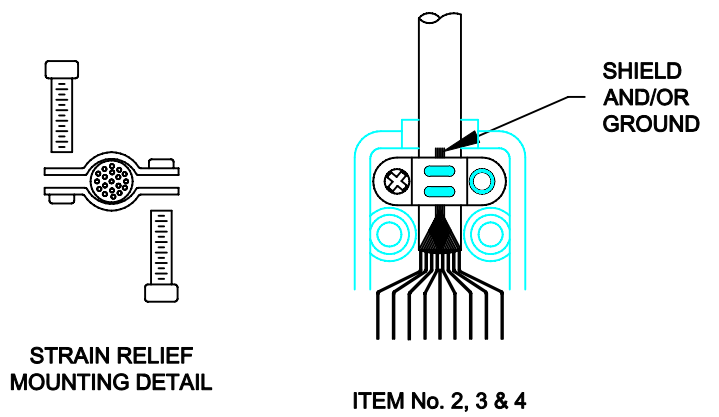
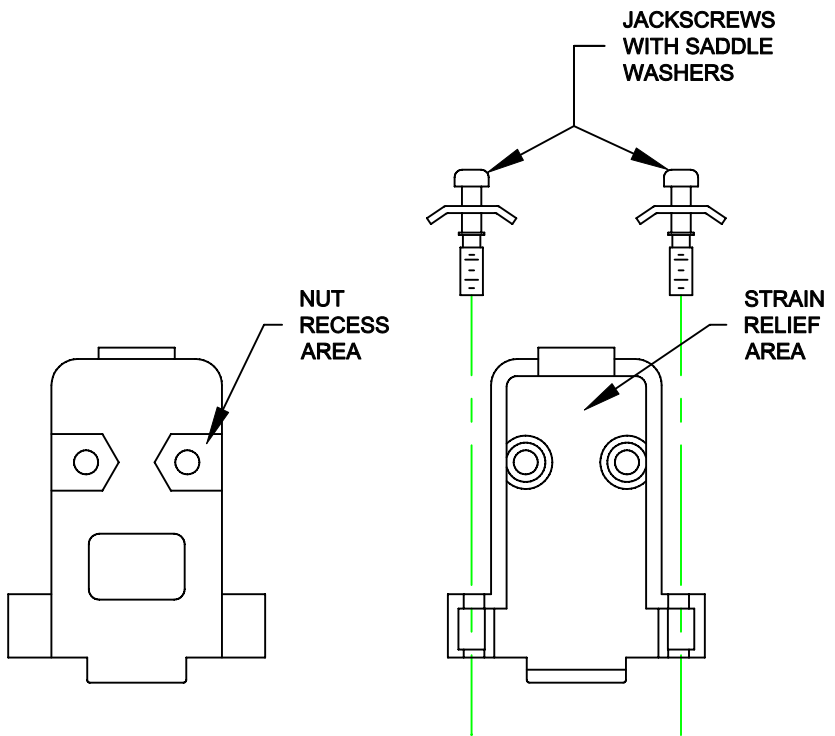

RoHS COMPLIANT

METALIZED PLASTIC

	THESE DRAWINGS AND SPECIFICATIONS ARE THE PROPERTY OF NorComp AND SHALL NOT BE REPRODUCED, COPIED OR USED AS THE BASIS FOR THE MANUFACTURE OF SALE OF APPARATUS WITHOUT WRITTEN PERMISSION.		DRAWN: C. SMITH	DATE: 03-29-06
			CHECKED: X	DATE: X
NorComp		SCALE: N.T.S.	SHEET 2	OF 4
		DWG NO. BACKSHELL - 977 SERIES		REV 0

ASSEMBLY INSTRUCTIONS:

1. PREPARE CABLE ENDS, CONNECT TO CONNECTOR
2. CLAMP STRAIN RELIEF ONTO CABLE MAKING SURE CABLE JACKET IS BELOW STRAIN RELIEF
3. PLACE STRAIN RELIEF INSIDE STRAIN RELIEF AREA OF ONE HOOD
4. PLACE THE JACKSCREWS INTO THE HOOD WITH THE CABLE
5. PLACE THE OTHER HALF OF THE HOOD ON TOP OF THE FIRST HALF, MAKING SURE NO WIRES ARE PINCHED
6. HOLDING THE HOODS TOGETHER, INSERT THE MOUNTING SCREWS THROUGH THE HOODS IN OPPOSITE DIRECTIONS. TIGHTEN THE TWO HALVES TOGETHER

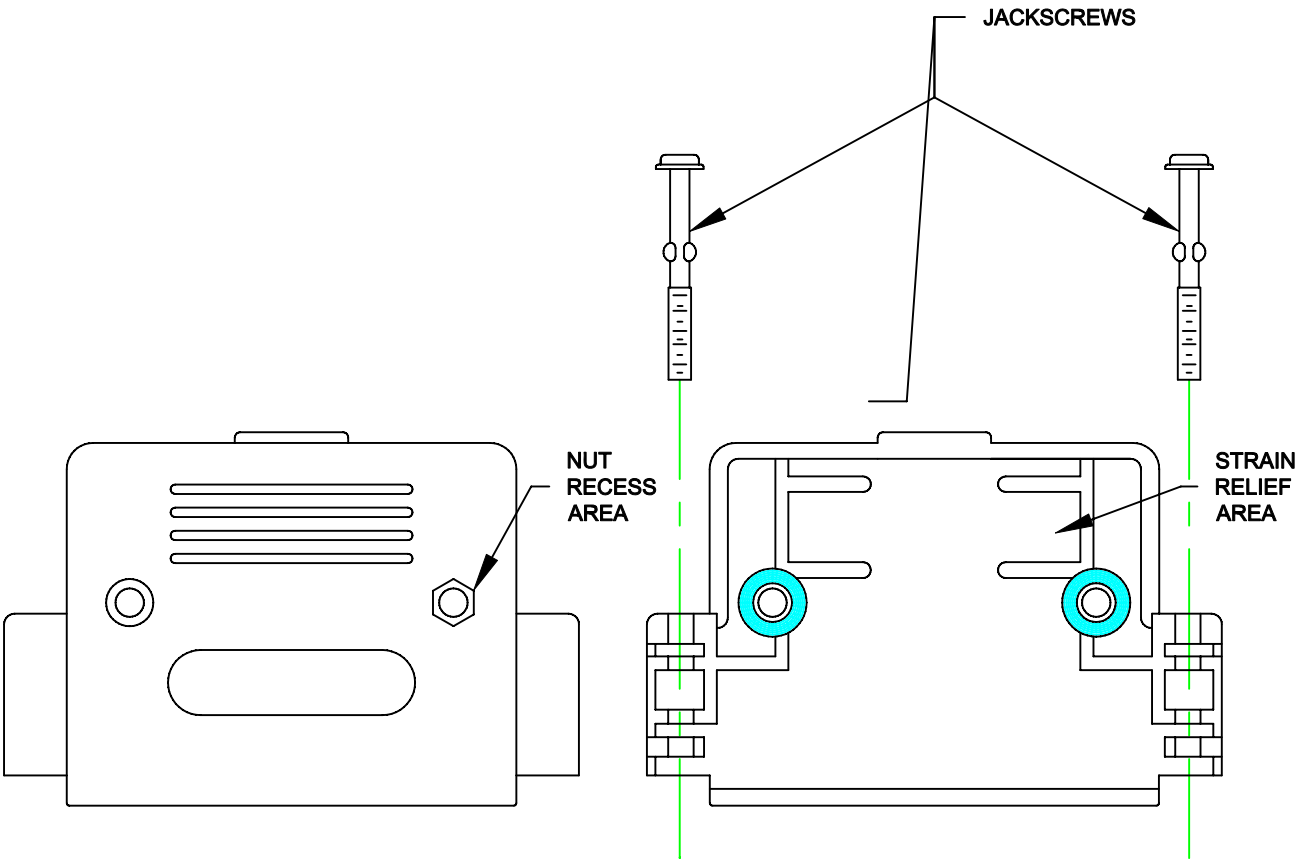

50 PIN

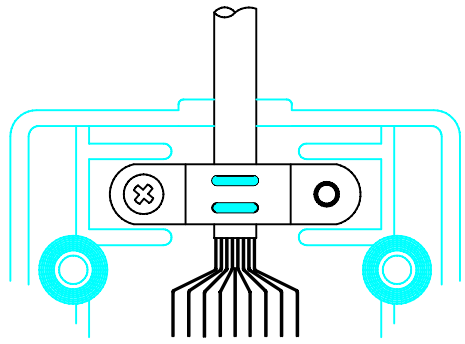

ITEM No. 2 & 3

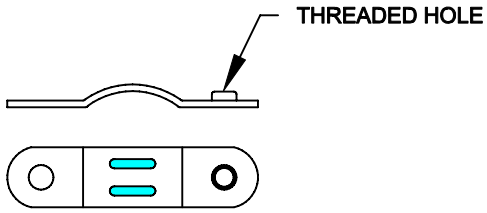

STRAIN RELIEF CLAMP

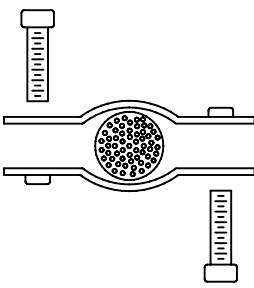

STRAIN RELIEF MOUNTING DETAIL

RoHS COMPLIANT

PLASTIC

	THESE DRAWINGS AND SPECIFICATIONS ARE THE PROPERTY OF NorComp AND SHALL NOT BE REPRODUCED, COPIED OR USED AS THE BASIS FOR THE MANUFACTURE OF SALE OF APPARATUS WITHOUT WRITTEN PERMISSION.		DRAWN: C. SMITH	DATE: 04-10-06
			CHECKED: X	DATE: X
NorComp	SCALE: N.T.S.	SHEET 3	OF 4	REV 0
	DWG NO. BACKSHELL - 977 SERIES			

DESCRIPTION: BACKSHELL ASSEMBLY INSTRUCTIONS - METALIZED PLASTIC

ASSEMBLY INSTRUCTIONS:

1. PREPARE CABLE ENDS, CONNECT TO CONNECTOR
2. CLAMP STRAIN RELIEF ONTO CABLE MAKING SURE CABLE JACKET IS BELOW STRAIN RELIEF
3. IF CABLE IS SHIELDED, FOLD SHIELD AND/OR GROUND WIRE BACK UNDER STRAIN RELIEF BEFORE CLAMPING. CUT ANY EXCESS WIRE FLUSH WITH THE TOP OF THE STRAIN RELIEF
4. PLACE STRAIN RELIEF INSIDE STRAIN RELIEF AREA OF ONE HOOD
5. PLACE THE JACKSCREWS INTO THE HOOD WITH THE CABLE
6. PLACE THE OTHER HALVE OF THE HOOD ON TOP OF THE FIRST HALF, MAKING SURE NO WIRES ARE PINCHED
7. HOLDING THE HOODS TOGETHER, INSERT THE MOUNTING SCREWS THROUGH THE HOODS IN OPPOSITE DIRECTIONS. TIGHTEN THE TWO HALVES TOGETHER

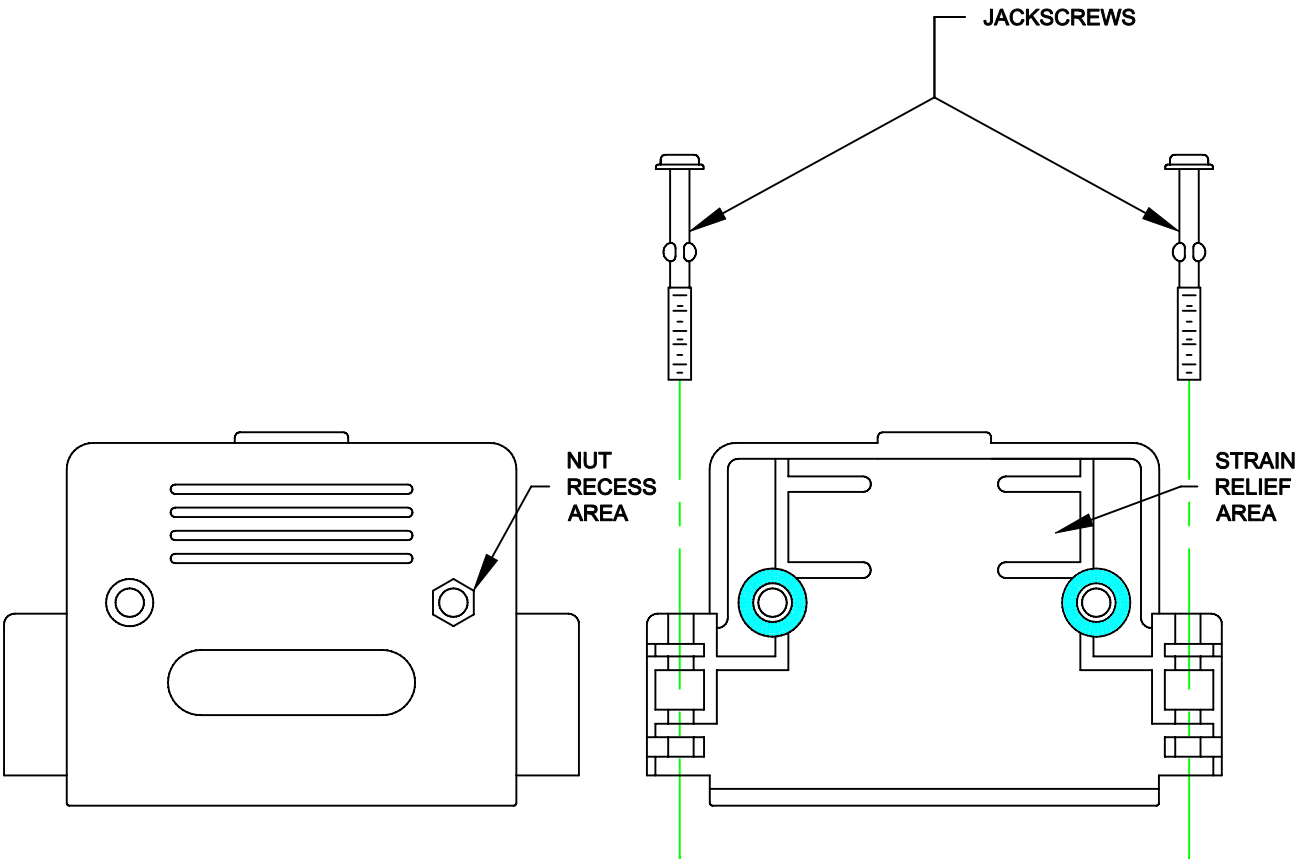

50 PIN

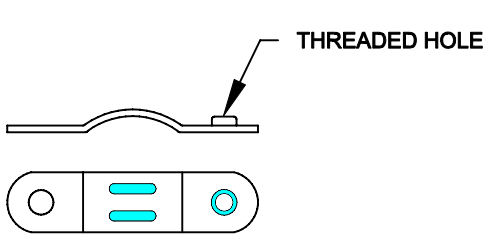
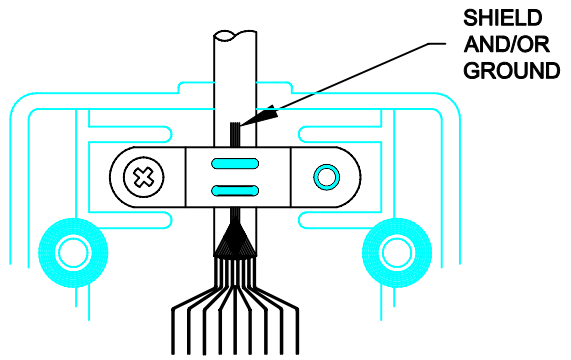

STRAIN RELIEF CLAMP

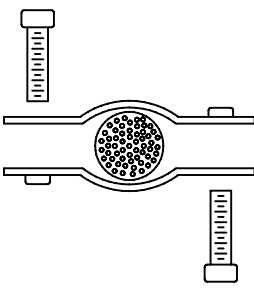

STRAIN RELIEF MOUNTING DETAIL

RoHS COMPLIANT

METALIZED PLASTIC

	THESE DRAWINGS AND SPECIFICATIONS ARE THE PROPERTY OF NorComp AND SHALL NOT BE REPRODUCED, COPIED OR USED AS THE BASIS FOR THE MANUFACTURE OF SALE OF APPARATUS WITHOUT WRITTEN PERMISSION.		DRAWN: C. SMITH	DATE: 04-10-06
			CHECKED: X	DATE: X
<h1>NorComp</h1>		SCALE: N.T.S.	SHEET 4 OF 4	REV 0
		DWG NO. BACKSHELL - 977 SERIES		