

CPDV5-3V3UP RoHS Device

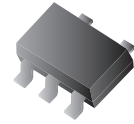

Features

- IEC61000-4-2 Level 4 ESD protection.
- Working voltage: 3.3V
- Low leakage current.
- Low operating and clamping voltages.

Mechanical data

- Case: SOT-353 standard package ,molded plastic.
- Terminals: Tin plated, solderable per MIL-STD-750,method 2026.
- Marking code: E3V3
- Mounting position: Any
- Weight: 0.0070 gram (approx.).

Circuit Diagram

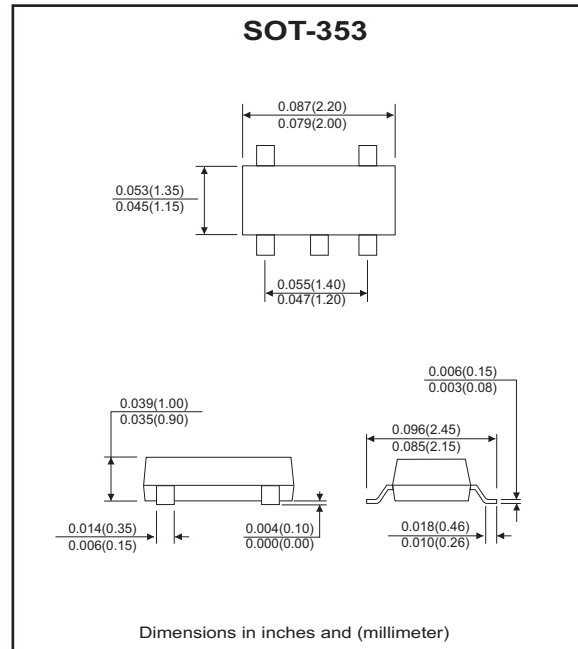
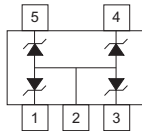

Maximum Ratings (at TA=25°C unless otherwise noted)

Parameter	Symbol	Value	Unit
Peak pulse power (tp = 8/20 us)	PPP	40	W
Peak pulse current (tp = 8/20 us)	I _{PP}	5	A
ESD per IEC 61000-4-2(Air) ESD per IEC 61000-4-2(Contact)	V _{ESD}	±20 ±15	kV
Operating temperature	T _j	-55 to +125	°C
Storage temperature	T _{STG}	-55 to +125	°C

Electrical Characteristics (at TA=25°C unless otherwise noted)

Parameter	Conditions	Symbol	Min	Typ	Max	Unit
Reverse stand-off voltage		V _{RWM}			3.3	V
Punch-through voltage	I _{PT} = 2uA	V _{PT}	3.5			V
Snap-back voltage	I _{SB} = 50mA	V _{SB}	2.8			V
Reverse leakage current	V _{RWM} = 3.3V	I _R		0.05	0.5	uA
Clamping voltage	I _{PP} = 1 A, tp=8/20us	V _C			5.5	V
	I _{PP} = 5 A, tp=8/20us	V _C			8.0	V
Reverse clamping voltage	I _{PPR} = 1 A, tp=8/20us	V _{CR}			2.4	V
Junction capacitance	V _R = 0 V, f = 1MHz	C _j		12	16	pF

RATING AND CHARACTERISTIC CURVES (CPDV5-3V3UP)

Fig. 1 - Non-repetitive max. peak pulse power vs. pulse time

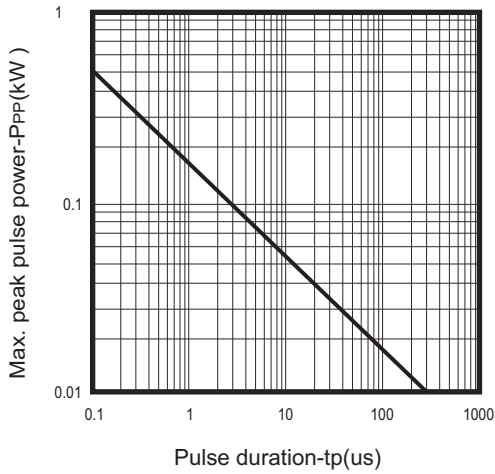

Fig. 2 - Power rating derating curve

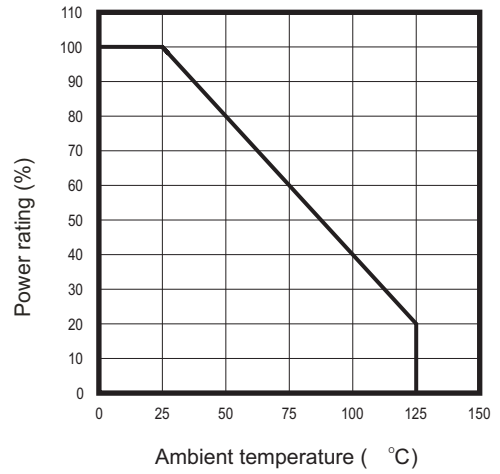

Fig.3 - Clamping voltage vs. peak pulse current

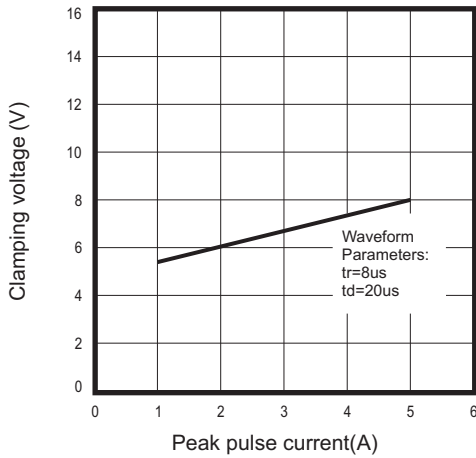

Fig.4 - Forward voltage vs. Forward current

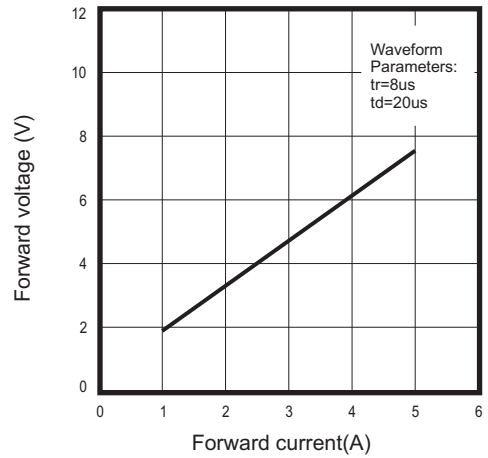
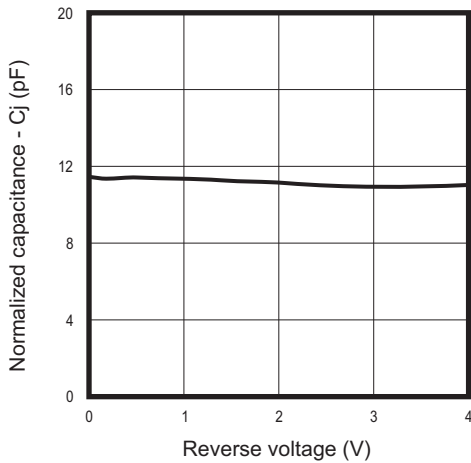
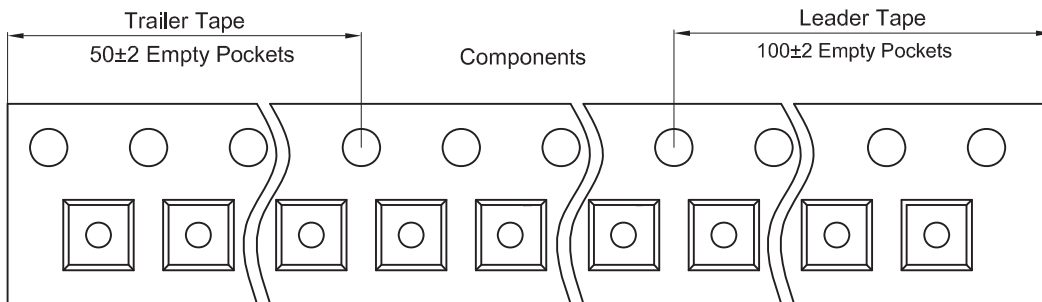
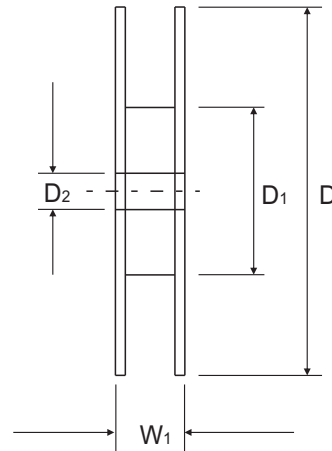
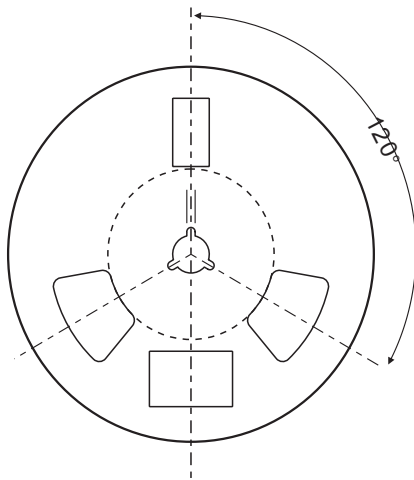
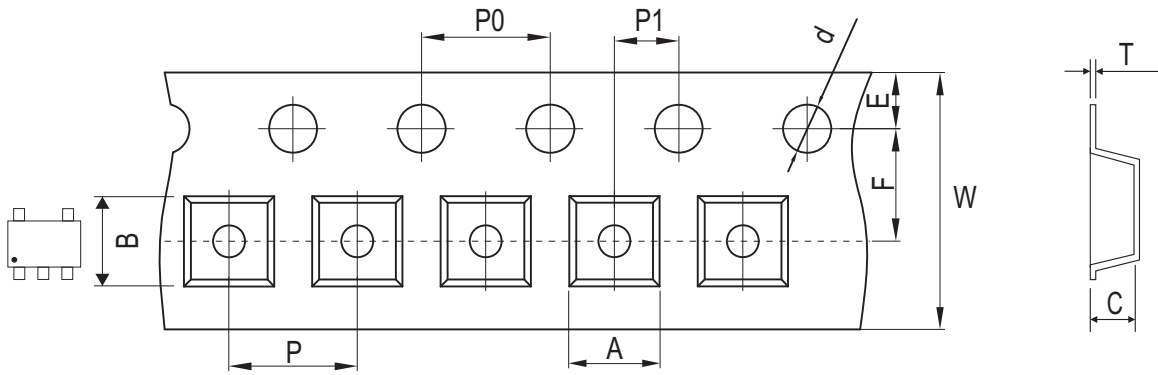

Fig.5 - Junction capacitance vs. reverse voltage



Reel Taping Specification



SOT-353	SYMBOL	A	B	C	d	D	D1	D2
	(mm)	2.25 ± 0.05	2.55 ± 0.05	1.20 ± 0.05	1.50 ± 0.10	178 ± 2.00	54.40 ± 1.00	13.00 ± 1.00
	(inch)	0.089 ± 0.002	0.100 ± 0.002	0.047 ± 0.002	0.059 ± 0.004	7.008 ± 0.079	2.142 ± 0.039	0.512 ± 0.039

SOT-353	SYMBOL	E	F	P	P0	P1	W	W1
	(mm)	1.75 ± 0.10	3.50 ± 0.10	4.00 ± 0.10	4.00 ± 0.10	2.00 ± 0.10	8.00 + 0.30 / - 0.10	12.30 ± 1.0
	(inch)	0.069 ± 0.004	0.138 ± 0.004	0.157 ± 0.004	0.157 ± 0.004	0.079 ± 0.004	0.315 + 0.012 / - 0.004	0.484 ± 0.039

Marking Code

Part Number	Marking Code
CPDV5-3V3UP	E3V3

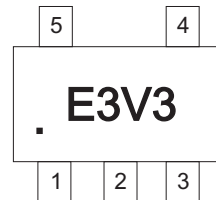

Suggested PAD Layout

SIZE	SOT-353	
	(mm)	(inch)
A	0.80	0.031
B	0.40	0.016
C	1.30	0.051
D	1.94	0.076
E	2.74	0.108

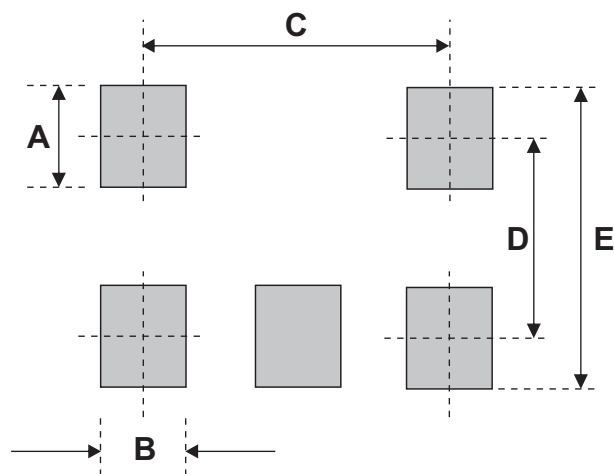

Standard Packaging

Case Type	REEL PACK	
	REEL (pcs)	Reel Size (inch)
SOT-353	3,000	7