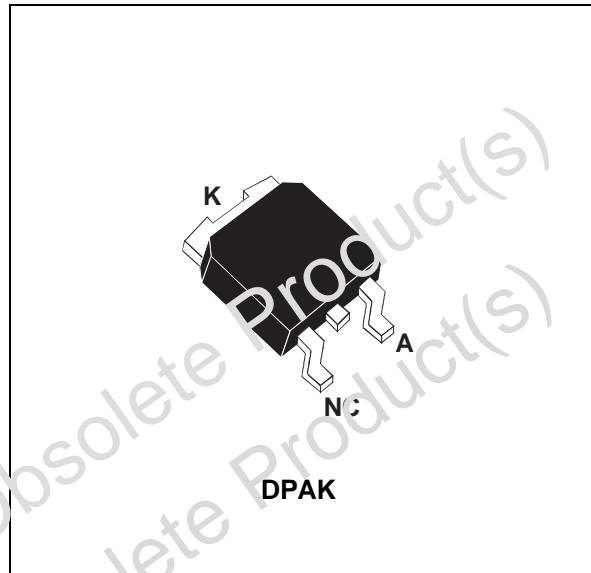

TURBOSWITCH™ ULTRA-FAST HIGH VOLTAGE DIODE
MAIN PRODUCT CHARACTERISTICS

I_{F(AV)}	3 A
V_{RRM}	600 V
t_{rr} (typ)	20 ns
V_F (max)	1.65 V

FEATURES AND BENEFITS

- SPECIFIC TO FREEWHEEL MODE OPERATIONS: FREEWHEEL OR BOOSTER DIODE.
- ULTRA-FAST, AND SOFT RECOVERY.
- VERY LOW OVERALL POWER LOSSES IN BOTH THE DIODE AND THE COMPANION TRANSISTOR.
- HIGH FREQUENCY OPERATIONS.

DESCRIPTION

The TURBOSWITCH is a very high performance series of ultra-fast high voltage power diodes. TURBOSWITCH family drastically cuts losses in both the diode and the associated switching IGBT or MOSFET in all freewheel mode operations and is particularly suitable and efficient in motor control

freewheel applications and in booster diode applications in Power Factor Control circuitries.

Packaged in DPAK, these 600V devices are particularly intended for use on 240V domestic mains.

ABSOLUTE RATINGS (limiting values)

Symbol	Parameter		Value	Unit
V _{RRM}	Repetitive peak reverse voltage		600	V
I _{F(RMS)}	RMS forward current		6	A
I _{FRM}	Repetitive peak forward current	tp=5 μs F=5 kHz square	20	A
I _{FSM}	Surge non repetitive forward current	tp=10 ms sinusoidal	35	A
T _j	Maximum operating junction temperature		125	°C
T _{stg}	Storage temperature range		- 65 to + 150	°C

TM : TURBOSWITCH is a trademark from STMicroelectronics

STTA306B

THERMAL AND POWER DATA

Symbol	Parameter	Tests conditions	Value	Unit
$R_{th(j-c)}$	Junction to case		6	°C/W
P_1	Conduction power dissipation	$I_{F(AV)} = 1.5A, \delta = 0.5$ $T_c = 110^\circ C$	2.5	W
P_{max}	Total power dissipation $P_{max} = P_1 + P_3$ ($P_3 = 10\% P_1$)	$T_c = 108^\circ C$	2.8	W

STATIC ELECTRICAL CHARACTERISTICS

Symbol	Parameter	Tests conditions	Min.	Typ.	Max.	Unit
V_F^{**}	Forward voltage drop	$T_j = 25^\circ C$			1.85	V
		$T_j = 125^\circ C$		1.3	1.65	
I_R^*	Reverse leakage current	$T_j = 25^\circ C$			20	μA
		$T_j = 125^\circ C$		500	1200	
V_{to}	Threshold voltage	$I_p < 3 \cdot I_{F(AV)}$			1.15	V
R_d	Dynamic resistance	$T_j = 125^\circ C$			175	m Ω

Test pulse : * $t_p = 380 \mu s, \delta < 2\%$
 ** $t_p = 5 ms, \delta < 2\%$

To evaluate the maximum conduction losses use the following equation :

$$P = V_{to} \times I_{F(AV)} + R_d \times I_{F(RMS)}^2$$

DYNAMIC ELECTRICAL CHARACTERISTICS

TURN-OFF SWITCHING

Symbol	Parameter	Test conditions	Min.	Typ.	Max.	Unit
t_{rr}		$T_j = 25^\circ C$ $I_F=0.5A \quad I_R=1A \quad I_{rr}=0.25A$ $I_F=1A \quad dI_F/dt = -50A/\mu s$ $V_R=30V$		20	50	ns
I_{RM}	Maximum reverse recovery current	$T_j = 125^\circ C$ $I_F=3A \quad V_R=400V$ $dI_F/dt = -16A/\mu s$ $dI_F/dt = -50A/\mu s$		2.0	1.2	A
S factor	Softness factor	$T_j = 125^\circ C$ $V_R=400V \quad I_F=3A$ $dI_F/dt = -50A/\mu s$		1.1		-

TURN-ON SWITCHING

Symbol	Parameter	Test conditions	Min.	Typ.	Max.	Unit
t_{fr}	Forward recovery time	$T_j = 25^\circ C$ $I_F=3A \quad dI_F/dt = 16A/\mu s$ Measured at $1.1 \times V_{Fmax}$			500	ns
V_{FP}	Peak forward voltage	$T_j = 25^\circ C$ $I_F=2A \quad dI_F/dt = 16A/\mu s$			10	V

Fig. 1: Conduction losses versus average current.

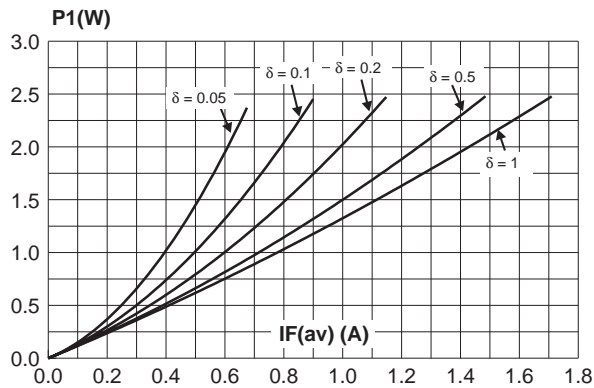

Fig. 2: Forward voltage drop versus forward current (maximum values).

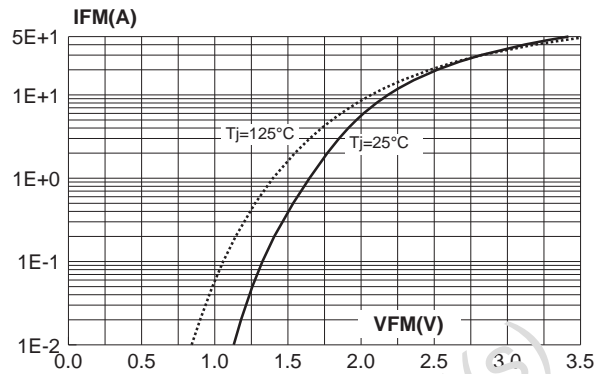

Fig. 3: Relative variation of thermal transient impedance junction to ambient versus pulse duration (recommended pad layout).

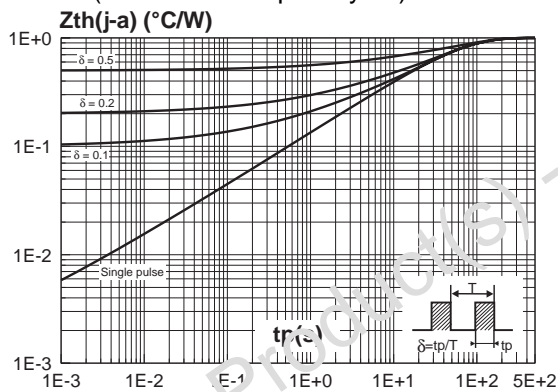

Fig. 4: Peak reverse recovery current versus dIF/dt (90% confidence).

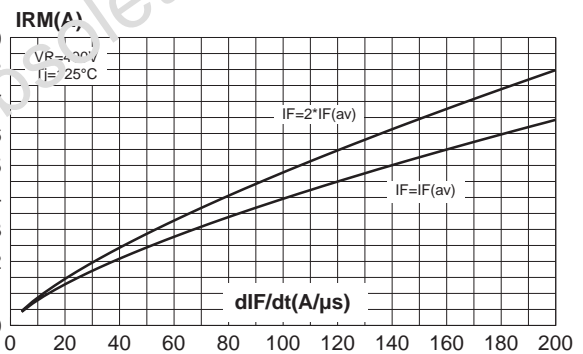

Fig. 5: Reverse recovery time versus dIF/dt (90% confidence).

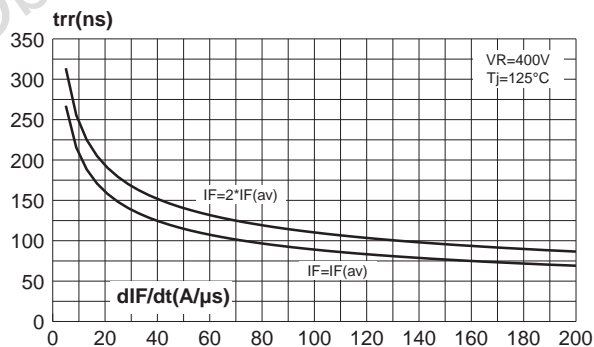

Fig. 6: Softness factor (t_b/t_a) versus dIF/dt (typical values).

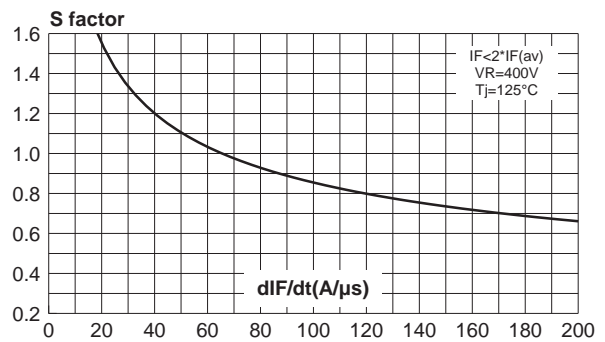

Fig. 7: Relative variation of dynamic parameters versus junction temperature (reference $T_j=125^\circ\text{C}$).

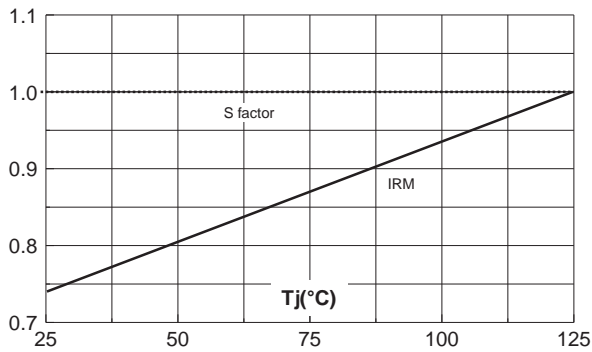

Fig. 8: Transient peak forward voltage versus dI_F/dt (90% confidence).

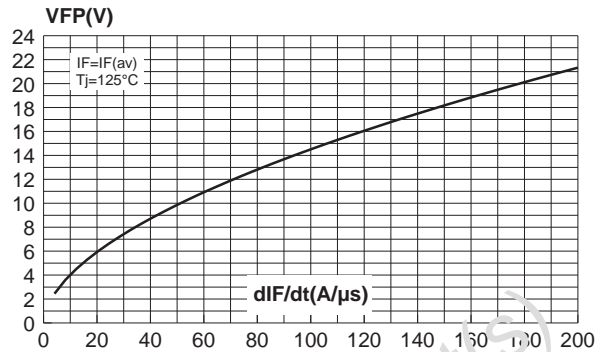

Fig. 9: Forward recovery time versus dI_F/dt (90% confidence).

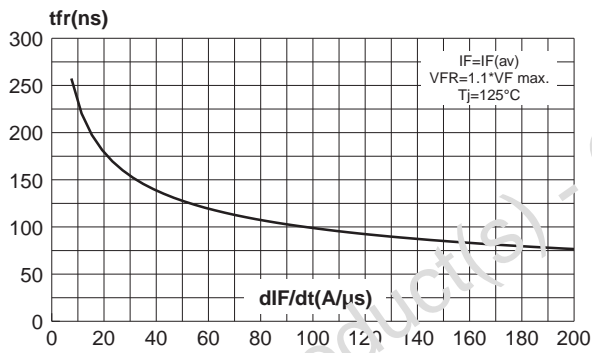
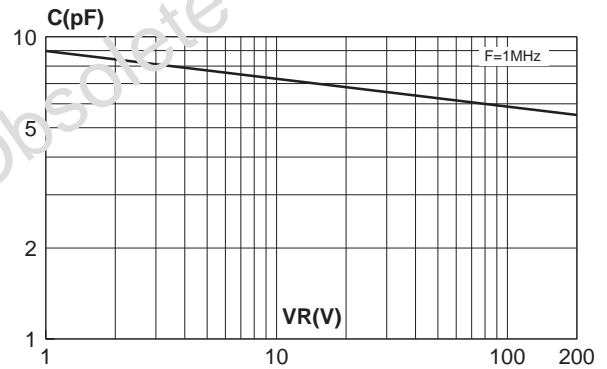

Fig. 10: Junction capacitance versus reverse voltage applied (typical values).



APPLICATION DATA

The TURBOSWITCH™ is especially designed to provide the lowest overall power losses in any Freewheel Mode application (see fig. A) considering both the diode and the companion transistor, thus optimizing the overall performance in the end application.

The way of calculating the power losses is given below :

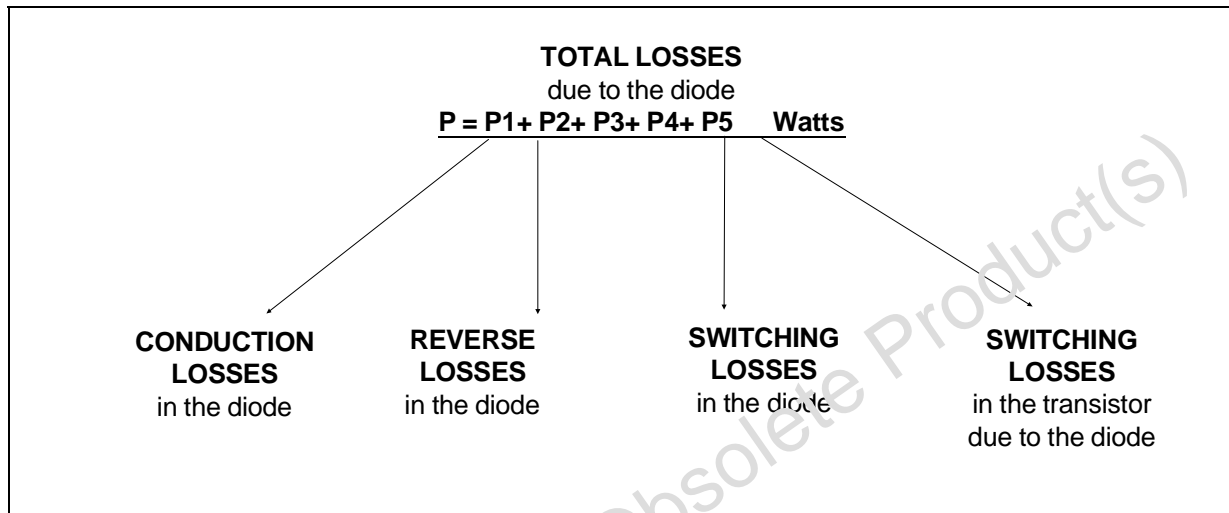
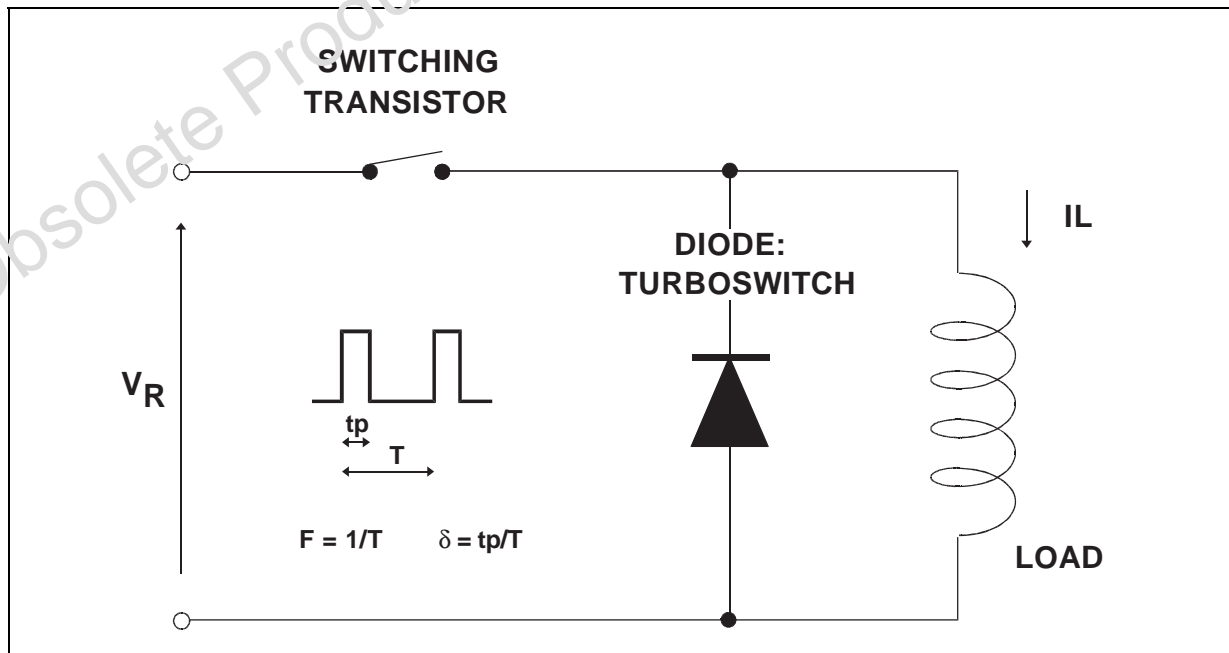
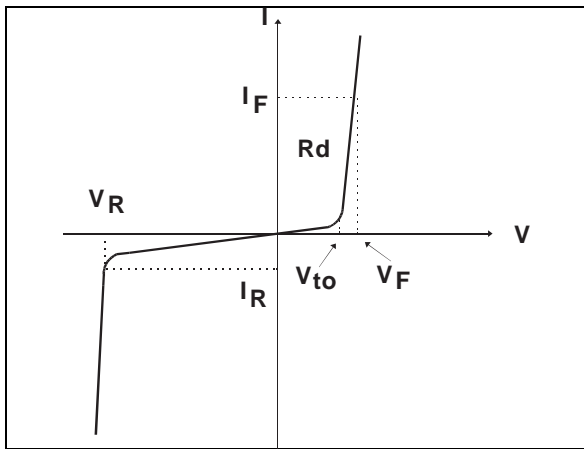

Fig. A : "FREEWHEEL" MODE



APPLICATION DATA (Cont'd)

Fig. B : STATIC CHARACTERISTICS



Conduction losses :

$$P1 = V_{to} \times I_{F(AV)} + R_d \times I_F^2(RMS)$$

Reverse losses :

$$P2 = V_R \times I_R \times (1 - \delta)$$

Fig. C : TURN-OFF CHARACTERISTICS

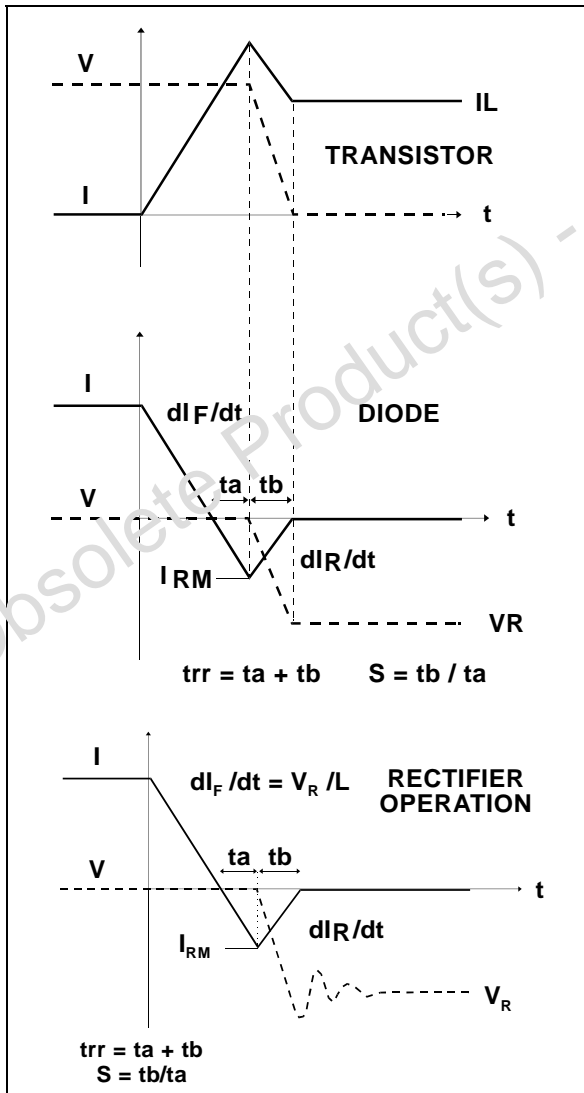

Turn-on losses
(in the transistor, due to the diode)

$$P5 = \frac{V_R \times I_{RM}^2 \times (3 + 2 \times S) \times F}{6 \times dI_F/dt} + \frac{V_R \times I_{RM} \times I_L \times (S + 2) \times F}{2 \times dI_F/dt}$$

Turn-off losses (in the diode) :

$$P3 = \frac{V_R \times I_{RM}^2 \times S \times F}{6 \times dI_F/dt}$$

P3 and P5 are suitable for power MOSFET and IGBT

APPLICATION DATA (Cont'd)

Fig. D : TURN-ON CHARACTERISTICS

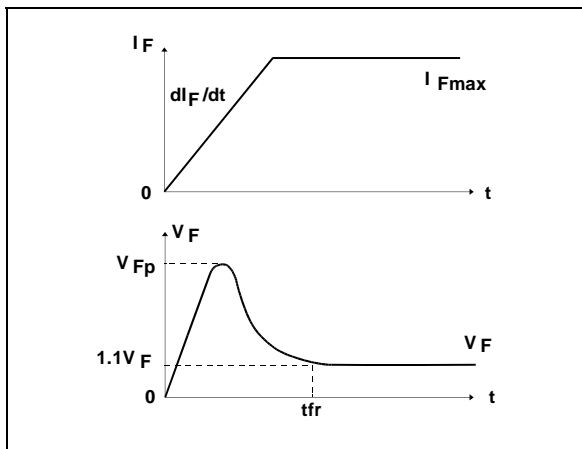

Turn-on losses :

$$P4 = 0.4 (V_{FP} - V_F) \times I_{Fmax} \times t_{fr} \times F$$

STTA306B

PACKAGE MECHANICAL DATA DPAK

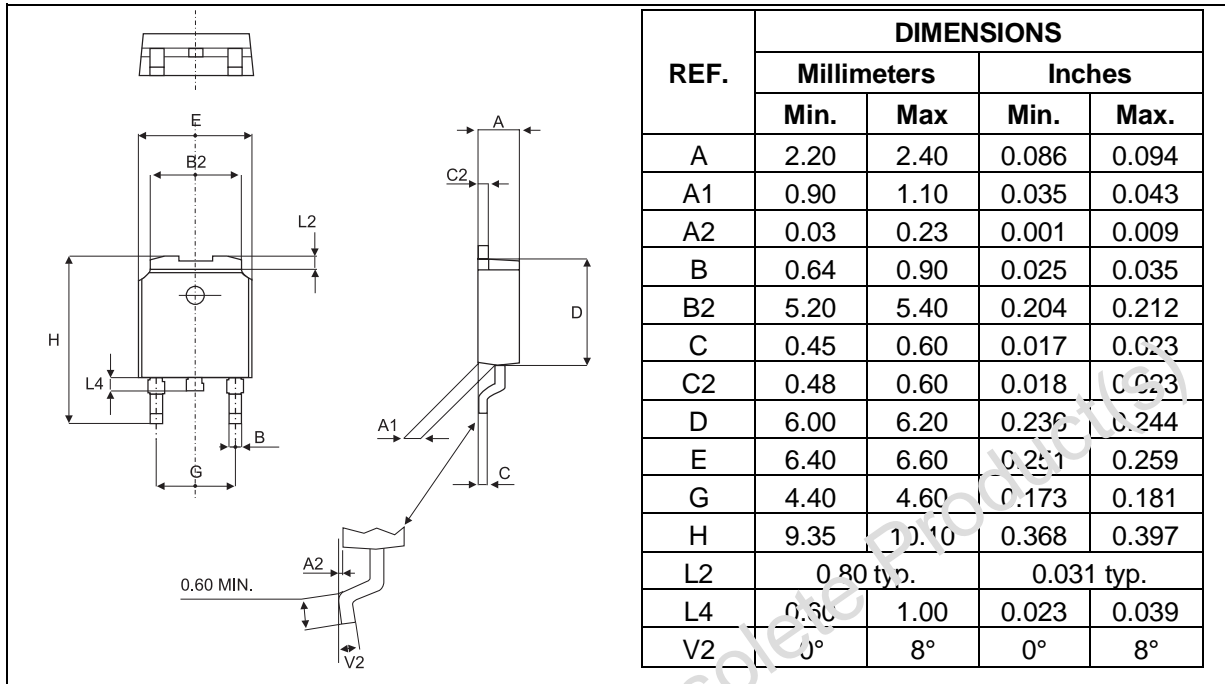

FOOTPRINT DIMENSIONS (in millimeters)

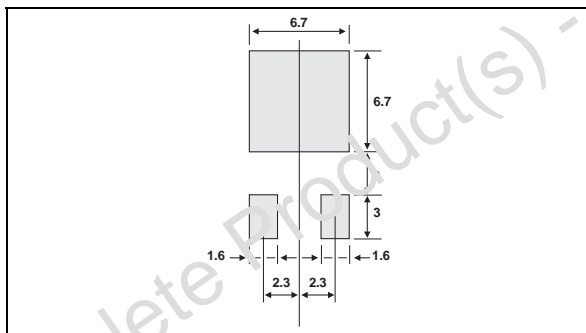

Ordering type	Marking	Package	Weight	Base qty	Delivery mode
STTA306B	A306	DPAK	0.3 g.	75	Tube
STTA306B-TR	A306	DPAK	0.3 g.	2500	Tape & reel

- Epoxy meets UL94,V0

Information furnished is believed to be accurate and reliable. However, STMicroelectronics assumes no responsibility for the consequences of use of such information nor for any infringement of patents or other rights of third parties which may result from its use. No license is granted by implication or otherwise under any patent or patent rights of STMicroelectronics. Specifications mentioned in this publication are subject to change without notice. This publication supersedes and replaces all information previously supplied. STMicroelectronics products are not authorized for use as critical components in life support devices or systems without express written approval of STMicroelectronics.

The ST logo is a registered trademark of STMicroelectronics

© 1999 STMicroelectronics - Printed in Italy - All rights reserved.

STMicroelectronics GROUP OF COMPANIES

Australia - Brazil - China - Finland - France - Germany - Hong Kong - India - Italy - Japan - Malaysia
Malta - Morocco - Singapore - Spain - Sweden - Switzerland - United Kingdom - U.S.A.

<http://www.st.com>