

LQW15AN9N7J80#

"#" indicates a package specification code.



< List of part numbers with package codes >
LQW15AN9N7J80D , LQW15AN9N7J80B

Shape

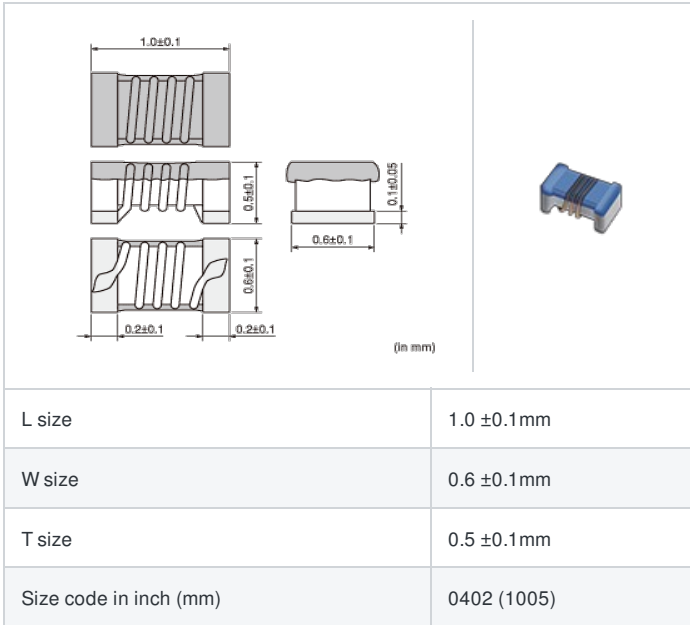

Notes

In operating temperature exceeding +85°C, derating of current is necessary for LQW15A_80 series.
Please apply the derating curve shown in chart according to the operating temperature.
Please confirm "Notice (Rating)".

References

Packaging code	Specifications	Minimum quantity
D	φ180mm Paper taping	10000
B	Packing in bulk	500

Mass (Typ.)	
1 piece	0.0009g

Specifications

Inductance	9.7nH ±5%
Inductance test frequency	100MHz
Rated current (Itemp) (Based on Temperature rise)	1400mA
Max. of DC resistance	0.081Ω
Q (min.)	33
Q test frequency	250MHz
Self resonance frequency (min.)	6.0GHz
Operating temperature range (Self-temperature rise is not included)	-55~125°C
Series	LQW15AN_80

Attention

- 1.This datasheet is downloaded from the website of Murata Manufacturing Co., Ltd. Therefore, it's specifications are subject to change or our products in it may be discontinued without advance notice. Please check with our sales representatives or product engineers before ordering.
- 2.This datasheet has only typical specifications because there is no space for detailed specifications. Therefore, please review our product specifications or consult the approval sheet for product specifications before ordering.

Chart of characteristic data (The charts below may show another part number which shares its characteristics.)

▪ Inductance-Frequency characteristics (Typ.)

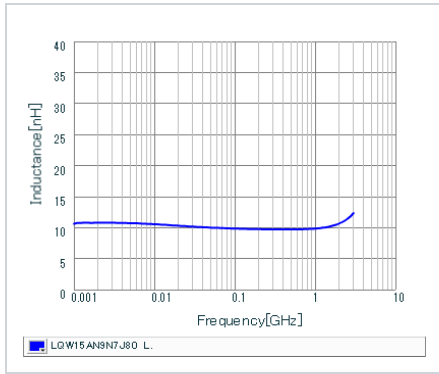

▪ Q-Frequency characteristics (Typ.)

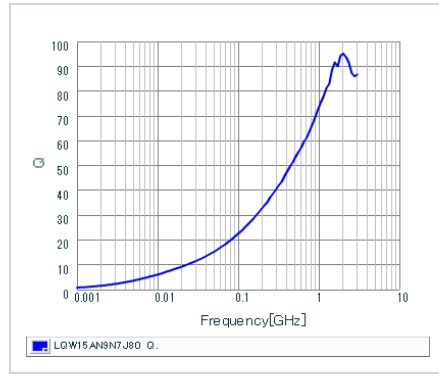

▪ Notice (Rating)

In operating temperature exceeding +85°C, derating of current is necessary for LQW15AN_8□ series. Please apply the derating curve shown in chart according to the operating temperature.

Derating of Rated Current

Operating Temperature (°C)	Current Derating (%)
0	100
85	100
125	50

⚠ Attention

- 1.This datasheet is downloaded from the website of Murata Manufacturing Co., Ltd. Therefore, it's specifications are subject to change or our products in it may be discontinued without advance notice. Please check with our sales representatives or product engineers before ordering.
- 2.This datasheet has only typical specifications because there is no space for detailed specifications. Therefore, please review our product specifications or consult the approval sheet for product specifications before ordering.