

Tandem 600V HYPERFAST BOOST DIODE
MAJOR PRODUCTS CHARACTERISTICS

I_{F(AV)}	5 A
V_{RRM}	600 V
T_j (max)	150 °C
V_F (max)	2.4 V
I_{RM} (typ.)	3.6 A
t_{rr} (typ.)	12 ns

FEATURES AND BENEFITS

- ESPECIALLY SUITED AS BOOST DIODE IN CONTINUOUS MODE POWER FACTOR CORRECTORS AND HARD SWITCHING CONDITIONS
- DESIGNED FOR HIGH di_F/dt OPERATION. HYPERFAST RECOVERY CURRENT TO COMPETE WITH SiC DEVICES. ALLOWS DOWNSIZING OF MOSFET AND HEATSINKS
- INTERNAL CERAMIC INSULATED DEVICES WITH EQUAL THERMAL CONDITIONS FOR BOTH 300V DIODES
- INSULATION (2500V_{RMS}) ALLOWS PLACEMENT ON SAME HEATSINK AS MOSFET FLEXIBLE HEATSINKING ON COMMON OR SEPARATE HEATSINK
- STATIC AND DYNAMIC EQUILIBRIUM OF INTERNAL DIODES ARE WARRANTED BY DESIGN
- Package Capacitance: C=7pF

ABSOLUTE RATINGS (limiting values)

Symbol	Parameter		Value	Unit
V _{RRM}	Repetitive peak reverse voltage		600	V
I _{F(RMS)}	RMS forward current		14	A
I _{FSM}	Surge non repetitive forward current	tp = 10 ms sinusoidal	60	A
I _{peak}	Peak current waveform	δ = 0.15 Tc = 140°C	8	A
T _{stg}	Storage temperature range		-65 +150	°C
T _j	Maximum operating junction temperature		+ 150	°C

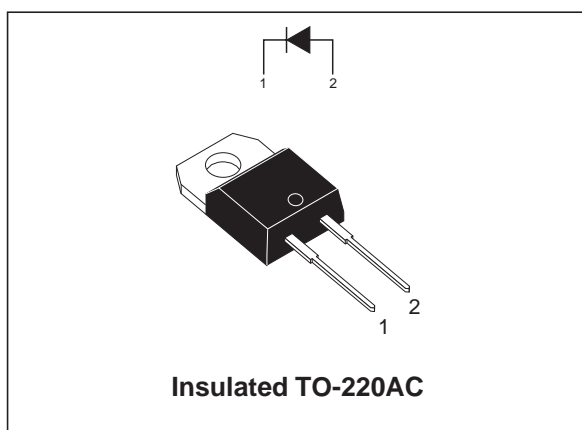
DESCRIPTION

The TURBOSWITCH "H" is an ultra high performance diode composed of two 300V dice in series. TURBOSWITCH "H" family drastically cuts losses in the associated MOSFET when run at high di_F/dt .

STTH506DTI

THERMAL AND POWER DATA

Symbol	Parameter	Test conditions	Value	Unit
$R_{th(j-c)}$	Junction to case thermal resistance		3.0	°C/W

STATIC ELECTRICAL CHARACTERISTICS

Symbol	Parameter	Tests Conditions	Min.	Typ.	Max.	Unit
I_R^*	Reverse leakage current	$V_R = V_{RRM}$	$T_j = 25^\circ\text{C}$		6	μA
			$T_j = 125^\circ\text{C}$		8	
V_F^{**}	Forward voltage drop	$I_F = 5\text{ A}$	$T_j = 25^\circ\text{C}$		3.6	V
			$T_j = 150^\circ\text{C}$		1.95	

Pulse test : * $t_p = 100\text{ ms}$, $\delta < 2\%$

** $t_p = 380\text{ }\mu\text{s}$, $\delta < 2\%$

To evaluate the maximum conduction losses use the following equation :

$$P = 1.7 \times I_{F(AV)} + 0.14 I_{F(RMS)}^2$$

DYNAMIC CHARACTERISTICS

Symbol	Parameter	Tests Conditions	Min.	Typ.	Max.	Unit	
t_{rr}	Reverse recovery time	$I_F = 0.5\text{ A}$ $I_{rr} = 0.25\text{ A}$ $I_R = 1\text{ A}$	$T_j = 25^\circ\text{C}$		12	ns	
		$I_F = 1\text{ A}$ $di_F/dt = -50\text{ A}/\mu\text{s}$ $V_R = 30\text{ V}$					25
I_{RM}	Reverse recovery current	$V_R = 400\text{ V}$ $I_F = 5\text{ A}$ $di_F/dt = -200\text{ A}/\mu\text{s}$	$T_j = 125^\circ\text{C}$		3.6	4.5	A
S	Reverse recovery softness factor				0.4		-
Q_{rr}	Reverse recovery charges				45		nC

TURN-ON SWITCHING CHARACTERISTICS

Symbol	Parameter	Tests Conditions	Min.	Typ.	Max.	Unit
t_{fr}	Forward recovery time	$I_F = 5\text{ A}$ $di_F/dt = 100\text{ A}/\mu\text{s}$ $V_{FR} = 1.1 \times V_F \text{ max}$			100	ns
V_{FP}	Transient peak forward recovery voltage	$I_F = 5\text{ A}$ $di_F/dt = 100\text{ A}/\mu\text{s}$			7	V

Fig. 1: Conduction losses versus average current.

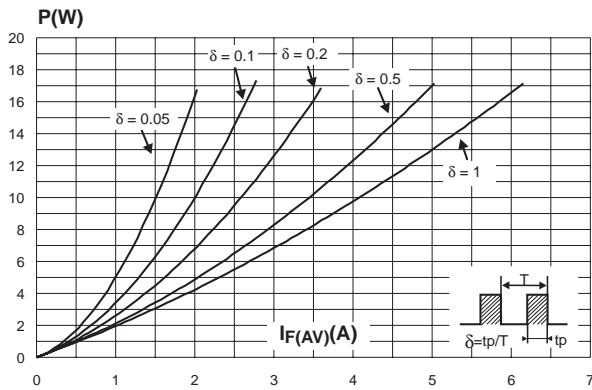

Fig. 2: Forward voltage drop versus forward current.

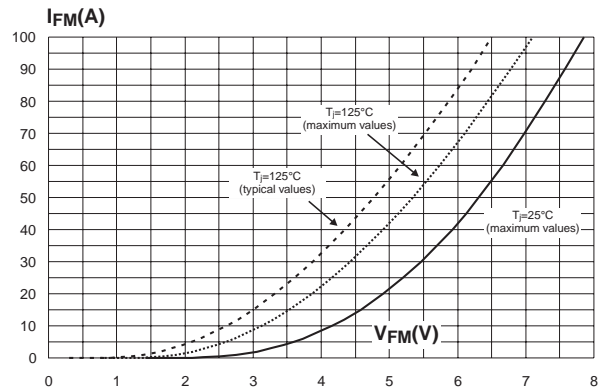

Fig. 3: Relative variation of thermal impedance junction to case versus pulse duration.

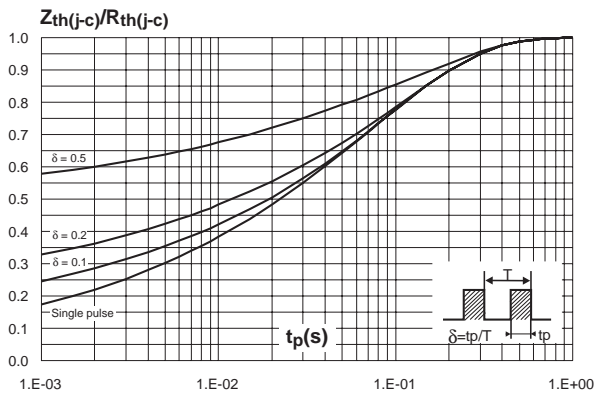

Fig. 4: Peak reverse recovery current versus di_F/dt (typical values).

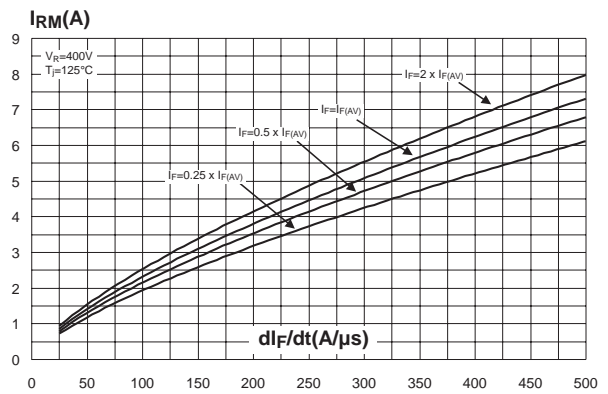

Fig. 5: Reverse recovery time versus di_F/dt (typical values).

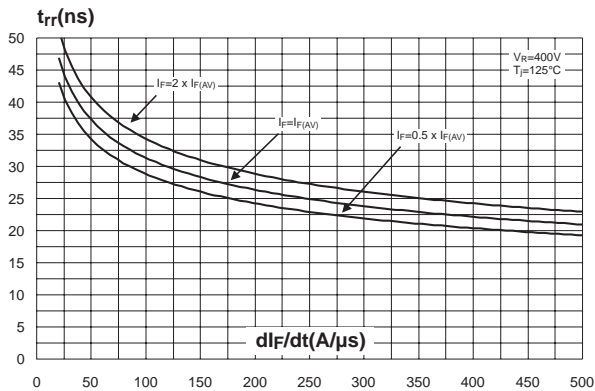

Fig. 6: Reverse recovery charges versus di_F/dt (typical values).

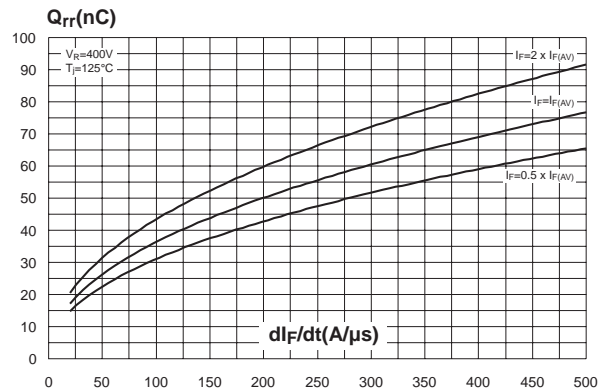

Fig. 7: Reverse recovery softness factor versus di_F/dt (typical values).

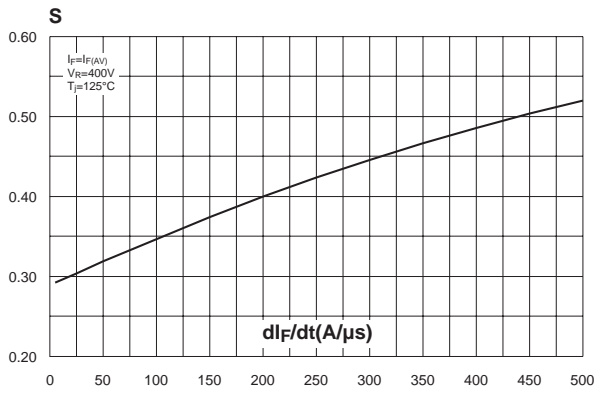

Fig. 8: Relative variation of dynamic parameters versus junction temperature (reference: $T_J = 125^\circ C$).

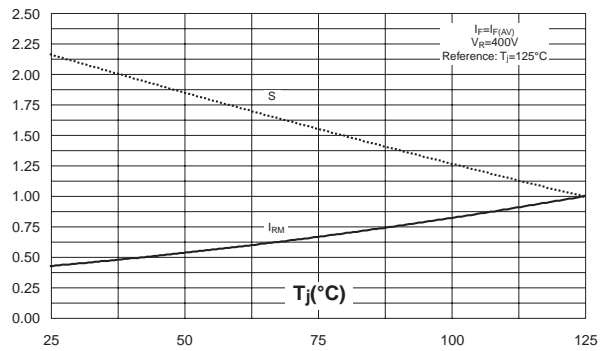

Fig. 9: Transient peak forward voltage versus di_F/dt (typical values).

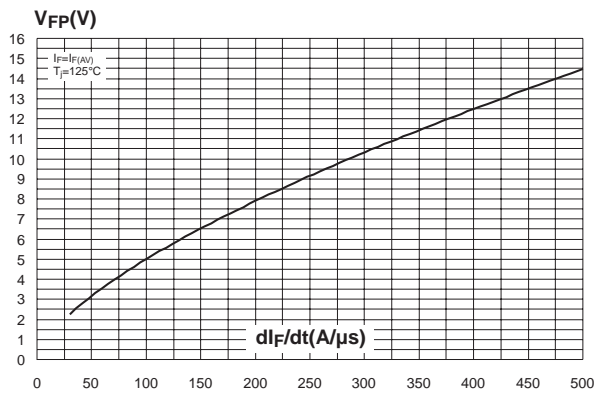

Fig. 10: Forward recovery time versus di_F/dt (typical values).

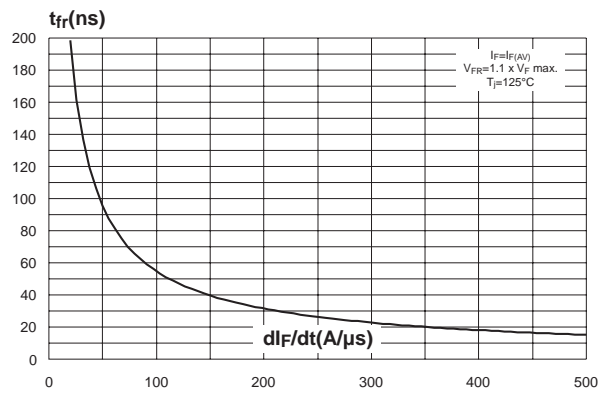
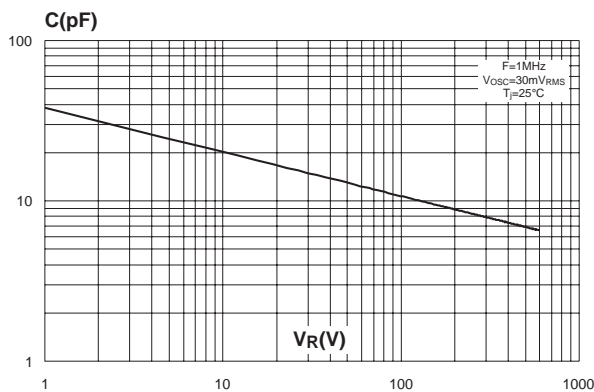
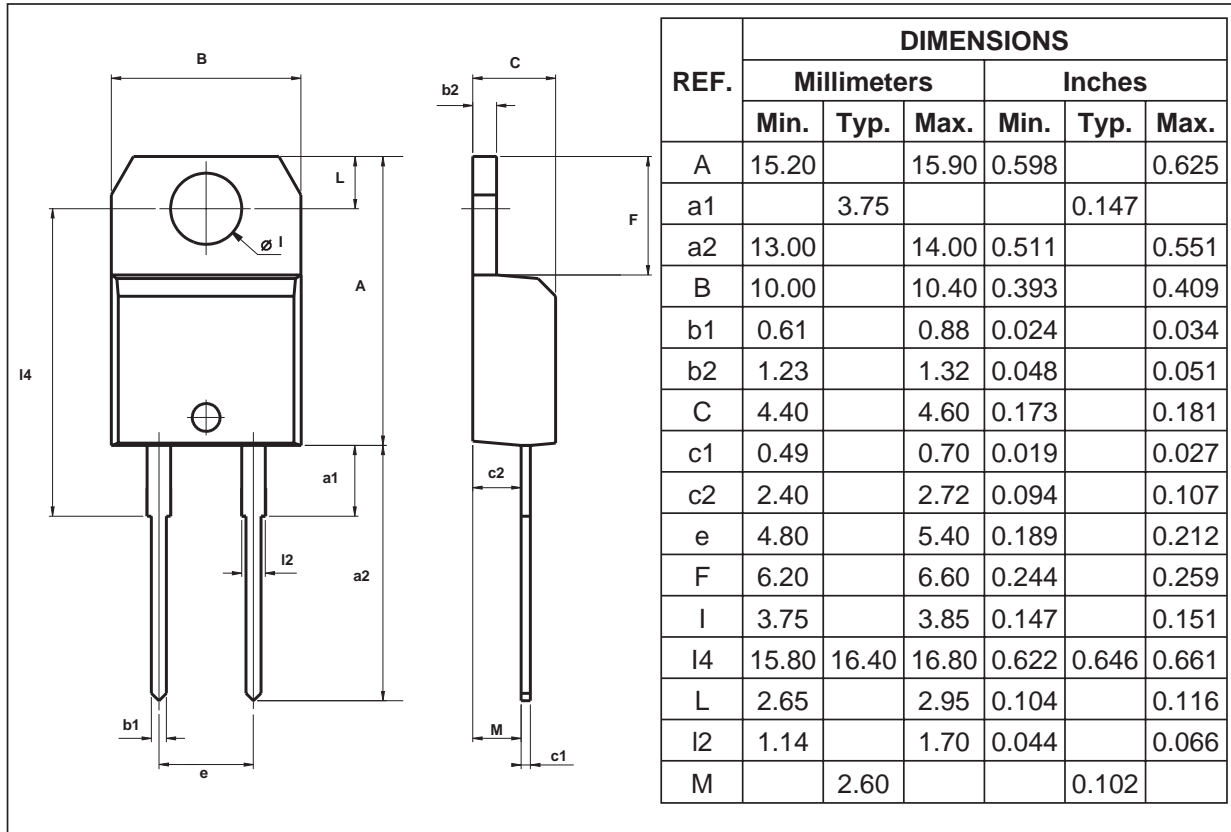

Fig. 11: Junction capacitance versus reverse voltage applied (typical values).



PACKAGE MECHANICAL DATA
 TO-220AC

Ordering code	Marking	Package	Weight	Base qty	Delivery mode
STTH506DTI	STTH506DTI	TO-220AC	2.3 g.	50	Tube

- Cooling method: C
- Recommended torque value: 0.8 N.m.
- Maximum torque value: 1 N.m.
- Epoxy meets UL94,V0

Information furnished is believed to be accurate and reliable. However, STMicroelectronics assumes no responsibility for the consequences of use of such information nor for any infringement of patents or other rights of third parties which may result from its use. No license is granted by implication or otherwise under any patent or patent rights of STMicroelectronics. Specifications mentioned in this publication are subject to change without notice. This publication supersedes and replaces all information previously supplied. STMicroelectronics products are not authorized for use as critical components in life support devices or systems without express written approval of STMicroelectronics.

The ST logo is a registered trademark of STMicroelectronics.

All other names are the property of their respective owners.

© 2003 STMicroelectronics - All rights reserved.

STMicroelectronics GROUP OF COMPANIES

Australia - Belgium - Brazil - Canada - China - Czech Republic - Finland - France - Germany -
 Hong Kong - India - Israel - Italy - Japan - Malaysia - Malta - Morocco - Singapore - Spain -
 Sweden - Switzerland - United Kingdom - United States

www.st.com